

AAKKOSELLINEN HAKEMISTO



3 -Pistenostin	212
A kut	51-55
E tuvaihteiston öljytiivisteet	197
Etuvarren puslasarja, Bronco	125-126
H ätäkatkaisijat	72
I lman-suodattimet	178-182
Iskunvaimentimen Jouset, Epi	87
Iskunvaimentimen suojat	86
Iskunvaimentimet, Bronco	79
Iskunvaimentimet, Fox	80-86
J arrulevyt	169-170
Jarrupalat, kengät brembo	157-160
Jarrupalat, kengät bronco	163-168
Jarrupalat, kengät prox	161-162
Jarrupalat, kengät sbs	152-156
Jarruvaijerit	148
Jännitteensäätimet	65-68
K aasutinlaipat	185
Kaasuvaierit	146-147
Ketjut	171-173
Kiertokankisarjat, Bronco	195-196
Kiertokankisarjat, Prox	190
Kiinnitysremmit	143
Korotuspalat tankoon	144
Korotussarjat, Epi	88
Kuljetuskori	47-48
Kytkimen jouset, Epi	202
Kytkimet, osat	199-202
Kytkinsarjat, Epi	198
Kytkinvaijerit	147
Kädensijanlämmittimet	145
Käsisuojat	144
L aukut	44-47
Levikepalat/Spacerit	22-23
Levitin	35
Lokasuojat	149
Lumiketjut	32
Lumilingot	33
Lämpötila anturit	71
M aaloustarvikkeet	212-213
Mittarit	140-142
Moottorisahan teline	48
Muoviklipsit, Bronco	149
Männäntapin laakerit, Prox	191
Männäntapin laakerit, Wiseco	186-188
Männät, Namura	185
Männät, Prox	189-190
Männät, Wiseco	186-188

N astat	34
Niittyleikkuri	212
O hjaustangon tarvikkeet	144
Ohjaustangot	143
P aikkaussarjat	22
Pakoputken villa	137
Pakoputket Gpr	137
Pakoputket SPI	135
Pakoputket Yoshimura	136
Pallonivelet Bronco,Epi	116-119
Peilit	142
Peitteet	151
Peräkäräryt	216
Powercommander	138-139
Puskulevyn varaosat	37
Puskulevyt/sarjat	35-38
Pyöränlaakerisarjat, Bronco	129-134
Pyöränlaakerit, Koyo	129
Pyöräsarjat	22
R aidetangon päät Bronco,Epi	120-124
Rattaat	174-177
Reet	217
Releet	65
Renkaat	14-21
Renkaat vihreä puoli	23
Rikastinvaijerit	147
Ristinivelet Bronco,Epi	111-115
Ruiskutuslaitteet, Fimco	213
Runkolaakerit ja Stefat, Prox	191
S atulanpäälliset	150-151
Sisärenkaat	22
Staattorin pick-up	65
Starttimoottorin osat	63-65
Starttimoottorit	61-63
Suutinsarjat	138-139
Sytytyspuolat	68-70
Sytytystulpat	56-60
T akaakselit	135
Takahaarukan puslasarjat	127-128
Takalana	212
Takavalot,lasit	78
Takavarren puslasarjat	127
Tavarateline	48
Telasarjat, Camopast	24-31
Tielana	217
Tiivistesarjat moottori Prox	191
Tiivistesarjat moottori Winderosa	192-194
Tukkipärry,-varusteet	214-216
Tupit	143
Tuulisuojat	49-50

V alovaihtajat	72
Valot	73
Valot, Strands	74-77
Vanteet	5-13
Variaattorihihnat	203-211
Vetoakselit, Bronco	89-93
Vetoakselit, Epi	94-97
Vetokoukut	217
Vetonivelet, Epi	97-102
Vetoniveliä suojakumit, Bronco	103-107
Vetoniveliä suojakumit, Epi	108-110
Vinssit, vinssien osat	39-43
Virranulosotto	142
Ö ljynjäähdyttäjän letkut	197
Öljynsuodattimet	181-184



s. 80

INDEX



A rm bearing kit, Bronco	125-126
Airfilters	178-182
B all Joints Bronco,Epi	116-119
Bar risers	144
Batteries	51-55
Boot kits, Bronco	103-107
Boot kits, Epi	108-110
Brake cable	148
Brake discs	169-170
Brakepads , shoes	152-156
Brakepads , shoes	157-160
Brakepads , shoes	161-162
Brakepads , shoes	163-168
C arb.flanges	185
Cargo boxes	44-47
Cargo rails	47-48
Chains	171-173
Chainsaw holder	48
Choke cables	147
Clutch cables	147
Clutch kits, Epi	198
Clutch parts	199-202
Clutch springs, Epi	202
Connecting rod kits, Bronco	195-196
Connecting rod kits, Prox	190
Covers	151
Crankshaft bearings and seals, Prox	191
Cv-joint, Epi	97-102
D rive belts	203-211
Drive shafts, Bronco	89-93
Drive shafts, Epi	94-97
E mergency switches	72
Exhaust packing	137
Exhaust systems Gpr	137
Exhaust systems SPI	135
Exhaust systems Yoshimura	136
F arm equipment	212-213
Fenderclips	149
Fenders	149
G as cables	146-147
Gasket kits engine Prox	191
Gasket kits engine Winderosa	192-194
H andlebar grips	143
Handlebars	143
Handprotectors	144
Handwarmers, grips	145
I gnition coils	68-70

J et kits	138-139
L ight switches	72
Lighting	73
Lighting Strand	74-77
Log trailer	214-216
M eters	140-142
Männät, Prox	189-190
O il filters	181-184
Oilcooler hoses	197
Oilseals, transmission	197
P iston pin bearings, Prox	191
Piston pin bearings, Wiseco	186-188
Pistons, Namura	185
Pistons, Wiseco	186-188
Power supply	142
Powercommander	138-139
R ack	48
Rear arm bushingkits	127
Rear axles	135
Rear light lenses	78
Rear view mirrors	142
Regulator	65-68
Relays	65
Rims	5-13
Riserkits, Epi	88
Risers, handlebar	144
Road scrapers	217
Roughcutter	212
S craping blade	212
Seat covers	150-151
Shock absorbers, Bronco	79
Shock absorbers, Fox	80-86
Shock Covers	86
Shock Springs, Epi	87
Snow chains	32
Snowblowers	33
Snowplow spare parts	37
Snowplows/kits	35-38
Spark plugs	56-60
Spikes	34
Sprayers, Fimco	213
Spreader	35
Sprockets	174-177
Starter parts	63-65
Startmotors	61-63
Stator pick-up	65
Swingarm Bushingkits	127-128

T emperature sensors	71
Three point lift	212
Tie downs	143
Tie-rods Bronco,Epi	120-124
Tire Repairkits	22
Tires	14-21
Tires misc.	23
Track kits, Camoplast	24-31
Trailer hitch ball	217
Trailer hitch balls	217
Trailers	216
Tubes	22
U -joints Bronco,Epi	111-115
W heel bearingkits, Bronco	129-134
Wheel sets	22
Wheel spacers	22-23
Wheelbearings, Koyo	129
Winches	39-43
Windscreens	49-50



p. 80



LIFE IS SHORT. THE TRAIL IS LONG.
YOU BEST GET AFTER IT.



ITP on maailman johtava mönkijänrenkaiden valmistaja. Renkaiden lisäksi ITP tarjoaa myös laajan valikoiman laadukkaita, mutta järkevän hintaisia alumiinivanteita.

VANTEET HYÖTYKÄYTTÖ

ITP SS -alumiinivanteet

ITP:n näyttävät ja luotettavat alumiinivanteet. SS-alumiinivanteilla annat mönkijällesi uuden ilmeen. Materiaalina on käytetty markkinoiden vahvinta ja keveintä alumiinia. Tyylikäs 6-12 -ikkunainen design kiilloitetulla viimeistelyllä. SS-kapselit vakiona. **Elinikäinen takuu materiaalille!**

Alkuperäiset mutterit sopivat ellei toisin ilmoiteta.

HURRICANE

uutuus!

Markkinoiden kestävin vanne tällä hetkellä? Puolien X-muoto on poikkeuksellisen kestävä. Uusi Rock Armor -vahvistettu sisempi vanne tekee kestävästä vanteesta vieläkin "luodinkestävämmän". Jokaisen vanteen mukana tulee ulkonäköön istuva SS™ -keskiö.

12"		
74-1080	12x7 4/110 5+2	119,00
74-1081	12x7 4/110 2+5	119,00
74-1082	12x7 4/115 5+2	119,00
74-1083	12x7 4/115 6+1	119,00
74-1084	12x7 4/137 5+2	119,00
74-1085	12x7 4/156 4+3	119,00
74-1086	12x7 4/156 6+1	119,00
74-1087	12x7 4/4 5+2	119,00
74-1088	12x7 4/4 2+5	119,00

14"			
74-1089	14x7 4/110 5+2	139,00	
74-1090	14x7 4/110 2+5	139,00	
74-1091	14x7 4/115 5+2	139,00	
74-1092	14x7 4/137 5+2	139,00	
74-1093	14x7 4/156 4+3	139,00	
74-1094	14x7 4/4 5+2	139,00	
74-1095	14x7 4/4 2+5	139,00	

15"			
74-1096	15x7 4/110 5+2	145,00	
74-1097	15x7 4/115 5+2	145,00	
74-1098	15x7 4/137 5+2	145,00	
74-1098	15x7 4/156 4+3	145,00	



Vanteet ja renkaat



Talvituotteet



Vinsit



Laukut ja tuulisuojat



Sähköosat



Jousitus ja voimansiirto



Pakoputket ja suutinsarjat



Ohjaus



Rungon osat ja peitteet



Jarrupalat ja rattaat



Moottori



Variaattorin osat



Maatalous-tarvikkeet



Kärryt ja reet

ATV



Vanteet ja renkaat



Talvituotteet



Vinssit



Laukut ja tuulisuojat



Sähköosat



Jousitus ja voimansiirto



Pakoputket ja suutinsarjat



Ohjaus



Rungon osat ja peitteet



Jarrupalat ja rattaat



Moottori



Variaattorin osat



Maatalous-tarvikkeet



Kärryt ja reet

ATV



SD 14" DUAL BEADLOCK

2-puoleinen lukkovanne todella kovaan käyttöön. Markkinoiden ensimmäinen yhdestä kappaleesta valmistettu vanne. Pitää renkaan tiukasti vanteella, eikä päästä sitä muljumaan sivuttaisuunnassa.

12"			
74-1070	DUAL Beadlock 14x7 5+2 4/110	280,00	
74-1072	DUAL Beadlock 14x7 5+2 4/115	280,00	
74-1073	DUAL Beadlock 14x7 4+3 4/137	280,00	
74-1075	DUAL Beadlock 14x7 4+3 4/156	280,00	



SD 12" BEADLOCK

Kevyt ja erittäin vankka 1-puoleinen lukkovanne, jossa ITP:n vahvistettu Rock Armor™ reunus.

12"		
74-1060	Beadlock 12x7 5+2 4/110	174,00
74-1063	Beadlock 12x7 4+3 4/137	174,00
74-1065	Beadlock 12x7 4+3 4/156	174,00





INNOVATION » TRACTION » PERFORMANCE

Miten vannekoko luetaan?

Esim vanne: ¹8x8, ²3+5, ³4/110

- 1 Vanteen halkaisija; myös vanteeseen sopivan renkaan koko. Käytä 8" vannetta 8" renkaaseen.
- 2 Vanteen leveys.
- 3 OFFSET Useimmat vanteet ovat keskitetty ilman offsettia. Offset tarkoittaa vanteen kiinnityskohtaa, esimerkiksi, 3+5, tarkoittaa 3" vanteen sisäreunasta ja 5" vanteen ulkoreunasta.
- 4 Pulttien määrä vanteessa.
- 5 Pulttien reikien välimatka (millimetreissä), mitattuna pultin reiän keskeltä vastapäisen pultin reiän keskustaan.

SS216

Kevyt ja alumiininen SS216 on juuri niin aggressiivinen kuin miltä se näyttää. Vanteen rakenteella on elinikäinen takuu. Uusi Rock Armor -vahvistettu sisempi vanne tekee kestävästä vanteesta vieläkin "luodinkestävämmän". Jokaisen vanteen mukana tulee ulkonäköön istuva SS™ -keskiö.



12"				
74-1040	12x7	5+2	4/110	125,10
74-1041	12x7	2+5	4/110	125,10
74-1042	12x7	5+2	4/115	125,10
74-1043	12x7	5+2	4/137	125,10
74-1044	12x7	5+2	4/156	125,10
14"				
74-1045	14x7	5+2	4/110	143,20
74-1046	14x7	2+5	4/110	143,20
74-1047	14x7	5+2	4/115	143,20
74-1048	14x7	5+2	4/137	143,20
74-1049	14x7	5+2	4/156	143,20



SS316

Materiaalit ja tyylikkyys ovat oleellista uudelle SS316-vanteelle. Tällä kevyellä alumiinivanteella on elinikäinen takuu. Rock Armor -rakenne. Jokaisen vanteen mukana tulee ulkonäköön istuva SS™ -keskiö.



12"				
74-1050	12x7	5+2	4/110	125,10
74-1051	12x7	2+5	4/110	125,10
74-1052	12x7	5+2	4/115	125,10
74-1053	12x7	5+2	4/137	125,10
74-1054	12x7	5+2	4/156	125,10
14"				
74-1055	14x7	5+2	4/110	143,20
74-1056	14x7	2+5	4/110	143,20
74-1057	14x7	5+2	4/115	143,20
74-1058	14x7	5+2	4/137	143,20
74-1059	14x7	5+2	4/156	143,20



Vanteet ja renkaat



Talvituotteet



Vinsit



Laukut ja tuulisuojat



Sähköosat



Jousitus ja voimansiirto



Pakoputket ja suutinsarjat



Ohjaus



Rungon osat ja peitteet



Jarrupalat ja rattaat



Moottori



Variaattorin osat



Maatalous-tarvikkeet



Kärryt ja reet

ATV



VANTEET HYÖTYKÄYTTÖ



SS ALLOY

SS312

12"	Hinta			
74-1030	12x7	5+2	4/110	130,10
74-1031	12x7	2+5	4/110	130,10
74-1032	12x7	5+2	4/115	130,10
74-1033	12x7	5+2	4/137	130,10
74-1034	12x7	4+3	4/156	130,10



SS212

12"	Hinta			
74-0980	12x7	5+2	4/110	125,10
74-0981	12x7	2+5	4/110	125,10
74-0982	12x7	5+2	4/115	125,10
74-0983	12x7	4+3	4/137	125,10
74-0985	12x7	4+3	4/156	125,10



14"	Hinta			
74-1000	14x6	4+2	4/110	130,10
74-1001	14x8	5+3	4/110	137,30
74-1002	14x8	3+5	4/110	137,30
74-1004	14x6	4+2	4/137	130,10
74-1005	14x8	5+3	4/137	137,30
74-1007	14x6	4+2	4/156	130,10
74-1008	14x8	5+3	4/156	137,30

SS212 MUSTA

12"	Hinta			
74-0990	12x7	5+2	4/110	125,10
74-0991	12x7	2+5	4/110	125,10
74-0992	12x7	5+2	4/115	125,10
74-0993	12x7	4+3	4/137	125,10
74-0995	12x7	4+3	4/156	125,10



14"	Hinta			
74-1010	14x6	4+2	4/110	130,10
74-1011	14x8	5+3	4/110	137,30
74-1012	14x8	3+5	4/110	137,30
74-1014	14x6	4+2	4/137	130,10
74-1015	14x8	5+3	4/137	137,30
74-1017	14x6	4+2	4/156	130,10
74-1018	14x8	5+3	4/156	137,30

SS212 15" ALUMIINI

15"	Hinta			
74-1076	15x7	5+2	4/110	157,30
74-1077	15x7	5+2	4/115	157,30
74-1078	15x7	5+2	4/137	157,30
74-1079	15x7	5+2	4/156	157,30



uutuus!



Vanteet ja renkaat



Talvutuotteet



Vinssit



Laukut ja tuulisuojat



Sähköosat



Jousitus ja voimansiirto



Pakoputket ja suutinsarjat



Ohjaus



Rungon osat ja peitteet



Jarrupalat ja rattaat



Moottori



Variaattorin osat



Maatalous-tarvikkeet



Kärryt ja reet

ATV

TERÄSVANTEET



Meiltä saat myös perinteiset mönkijän peltivanteet.

DELTA STEEL



uutuus!



BRONCO
ATV COMPONENTS

12"				Ovh.
74-0800	DELTA HOPEA 12x7	4/115	5+2	71,50
74-0801	DELTA HOPEA 12x7	4/115	2+5	71,50
74-0802	DELTA HOPEA 12x7	4/110	5+2	71,50
74-0803	DELTA HOPEA 12x7	4/110	2+5	71,50
74-0804	DELTA HOPEA	4/110	4+3*	71,50
74-0805	DELTA HOPEA 12x7	4/137	5+2	71,50
74-0806	DELTA HOPEA 12x7	4/137	2+5	71,50
74-0807	DELTA HOPEA 12x7	4/156	4+3	71,50
74-0808	DELTA HOPEA 12x7	4/4	2+5	71,50
74-0812	DELTA BLACK	4/110	4+3*	71,50
74-0813	DELTA BLACK 12x7	4/110	5+2	71,50
74-0814	DELTA BLACK 12x7	4/110	2+5	71,50
74-0815	DELTA BLACK 12x7	4/4	2+5	71,50
74-0816	DELTA BLACK 12x7	4/137	4+3	71,50
74-0817	DELTA BLACK 12x7	4/137	3+4	71,50
74-0818	DELTA BLACK 12x7	4/156	4+3	71,50

*) Yamaha Grizzly 550-700 07-12

14"				Ovh.
74-06352	Bronco, Musta	4/110	4+3	69,00
74-06353	Bronco, Musta	4/115	4+3	69,00
74-06354	Bronco, Musta	4/137	4+3	69,00
74-06355	Bronco, Musta	4/156	4+3	69,00

MUTTERIT



Tuotenumero						Hinta
74-080	MUTTERISARJA	ITP	16kpl	10mm x 1,50mm	60° kartio	28,30
74-081	MUTTERISARJA	ITP	16kpl	10mm x 1,25mm	60° kartio, Musta	28,30
74-082	MUTTERISARJA	ITP	16kpl	10mm x 1,25mm	60° kartio	28,30
74-082-1	MUTTERI	ITP	kpl	10mm x 1,25mm	60° kartio	2,10
74-083	MUTTERISARJA	ITP	16kpl	3/8" -24	90°	28,30
74-083-1	MUTTERI	ITP	kpl	3/8" -24	90°	2,10
74-084-1	MUTTERI	ITP	kpl	1/2" -20	90°	2,10
74-085	MUTTERISARJA	ITP	16kpl	12mm x 1,50mm	60° kartio	28,30
74-086	MUTTERISARJA	ITP	16kpl	3/8" -24	60° kartio	28,30
74-093	MUTTERISARJA	ITP	16kpl	10mm x 1,25mm	90°	28,30
74-093-1	MUTTERI	ITP	kpl	10mm x 1,25mm	90°	2,10
74-094	MUTTERISARJA	ITP	16kpl	12mm x 1,25mm	90°	28,30



KAPSELIT



Tuotenumero						Hinta
74-088	KAPSELISARJA	ITP	4kpl	C-5,C-6,C-7	4/110,4/115	24,30
74-098	KAPSELISARJA	ITP	4kpl	C-5,C-6,C-7	4/110,4/115, Musta	24,30
74-089	KAPSELISARJA	ITP	4kpl	C-5,C-6,C-7	4/137	24,30
74-099	KAPSELISARJA	ITP	4kpl	C-5,C-6,C-7	4/137 Musta	24,30
74-090	KAPSELISARJA	ITP	4kpl	C-5,C-6,C-7	4/156	24,30
74-090-1	KAPSELISARJA	ITP	4kpl	C-5,C-6,C-7	4/156 Musta	24,30
74-092	KAPSELISARJA	ITP	4kpl	DELTA	4/110,4/115	24,30
74-092-1	KAPSELISARJA	ITP	4kpl	DELTA	4/110,4/115, Musta	24,30
74-095	KAPSELI	ITP	kpl	SS	4/110,4/115	6,20
74-095-1	KAPSELI	ITP	kpl	SS	4/110,4/115, Musta	6,20
74-096	KAPSELI	ITP	kpl	SS	4/137	6,20
74-097	KAPSELI	ITP	kpl	SS	4/156	6,20
74-100	KAPSELI	ITP	kpl	SS 312	4/110,4/115	6,20
74-101	KAPSELI	ITP	kpl	SS 312	4/137	6,20
74-102	KAPSELI	ITP	kpl	SS 312	4/156	6,20
74-103	KAPSELI	ITP	kpl	Hurricane	4/110,4/115, 4/137, 4/156	6,00
74-104	KAPSELI	ITP	kpl	Hurricane	4/4	6,00



DELTA



DELTA, MUSTA



C-5,C-6,C-7



C-5,C-6,C-7, MUSTA



SS



SS 312



Vanteet ja renkaat



Talvituet



Vinsit



Laukut ja tuulisuojat



Sähköosat



Jousitus ja voimansiirto



Pakoputket ja suutinsarjat



Ohjaus



Rungon osat ja peitteet



Jarrupalat ja rattaat



Moottori



Variaattorin osat



Maatalous-tarvikkeet



Kärryt ja reet

ATV





Vanteet ja renkaat



Talvituotteet



Vinssit



Laukut ja tuulisuojat



Sähköosat



Jousitus ja voimansiirto



Pakoputket ja suutinsarjat



Ohjaus



Rungon osat ja peitteet



Jarrupalat ja rattaat



Moottori



Variaattorin osat



Maatalous-tarvikkeet



Kärryt ja reet

ATV



SS 216



SS 316



MÖNKIJÄ JA VANNE SUOSITUKSET: HYÖTY

Jako 4/110, Offset 5+2/2+5

Bombardier	
•	Bombardier Traxter 4x4 '99-06
•	Bombardier Quest 650 '01-06
Honda	
•	Honda 300 4x4 '89-00
•	Honda 350 Rancher S-ES 4x4 '00-06
•	Honda 400/420 Rancher 4x4 '04-14 (Jäykkäperä)
•	Honda 400 Foreman 4x4 '96-06
•	Honda 450/500 Foreman S-ES 4x4 '98-14
•	Honda 500 Rubicon 4x4 '01-14
Kymco	
•	Kymco MXU500 4x4 '06-09

Suzuki	
•	Suzuki 400 Eiger 4x4 '02-07
•	Suzuki 400 King Quad 4x4 08-14 (Jäykkäperä)
•	Suzuki 500 Vinson 4x4 '02-09
Yamaha	
•	Yamaha 350 Grizzly 4x4 '07-13 (Jäykkäperä)
•	Yamaha 350/400 Big Bear 2x4/4x4 '87-06
•	Yamaha 350/450 Wolverine 4x4 '95-11
•	Yamaha 350 Bruin 2x4/4x4 '04-06
•	Yamaha 400/450 Kodiak 4x4 '93-04
•	Yamaha 600 Grizzly 4x4 '98-01

*) Käytettävä mutterisarjaa 74-082.

12 tuumaa	Väri	Koko	Offset	Jako	Tuotenro	Hinta	Mutterisarja (16kpl)	Hinta	
SS 216	ETU	ALU/BLACK	12x7	5+2	4/110	74-1040	125,10	74-082	28,30
SS 216	TAKA	ALU/BLACK	12x7	2+5	4/110	74-1041	125,10	74-082	28,30
SS 316	ETU	ALU/BLACK	12x7	5+2	4/110	74-1050	125,10	74-082	28,30
SS 316	TAKA	ALU/BLACK	12x7	2+5	4/110	74-1051	125,10	74-082	28,30
SS 312	ETU	ALU	12x7	5+2	4/110	74-1030	129,00	74-082	28,30
SS 312	TAKA	ALU	12x7	2+5	4/110	74-1031	129,00	74-082	28,30
SS 212	ETU	ALU	12x7	5+2	4/110	74-0980	125,10	74-082	28,30
SS 212	TAKA	ALU	12x7	2+5	4/110	74-0981	125,10	74-082	28,30
SS 212	ETU	BLACK	12x7	5+2	4/110	74-0990	125,10	74-082	28,30
SS 212	TAKA	BLACK	12x7	2+5	4/110	74-0991	125,10	74-082	28,30
SS 112	ETU	ALU	12x7	5+2	4/110	74-0960	120,00	74-082	28,30
SS 112	TAKA	ALU	12x7	2+5	4/110	74-0961	120,00	74-082	28,30
14 tuumaa	Väri	Koko	Offset	Jako	Tuotenro	Hinta	Mutterisarja	Hinta	
SS 216	ETU	ALU/BLACK	14x7	5+2	4/110	74-1045	143,20	74-082	28,30
SS 216	TAKA	ALU/BLACK	14x7	2+5	4/110	74-1046	143,20	74-082	28,30
SS 316	ETU	ALU/BLACK	14x7	5+2	4/110	74-1055	143,20	74-082	28,30
SS 316	TAKA	ALU/BLACK	14x7	2+5	4/110	74-1056	143,20	74-082	28,30
SS212	ETU	ALU	14x6	4+2	4/110	74-1000	130,10	74-082	28,30
SS212	TAKA	ALU	14x8	3+5	4/110	74-1002	137,30	74-082	28,30
SS212	ETU	BLACK	14x6	4+2	4/110	74-1010	130,10	74-082	28,30
SS212	TAKA	BLACK	14x8	3+5	4/110	74-1012	137,30	74-082	28,30

MÖNKIJÄ JA VANNE SUOSITUKSET: HYÖTY



Jako 4/110, Offset 5+2/5+2

Honda

- Honda 420 Rancher IRS 4x4 '09-14
- Honda 650/700 Rincon 4x4 '02-14

Kawasaki

- Kawasaki 650i Brute Force 4x4 '06-13
- Kawasaki 750 Brute Force 4x4 '05-14

Suzuki

- Suzuki 450/700/750 King Quad '05-14

Yamaha

- Yamaha 400/450 Big Bear IRS '07-14
- Yamaha 550/660/700 Grizzly 4x4 '02-14
- Yamaha 450/660/700 Rhino '04-13

12 tuumaa	Väri	Koko	Offset	Jako	Tuotenro	Hinta	Mutterisarja	Hinta	
SS 216	ETU	Alu/Black	12x7	5+2	4/110	74-1040	125,10	74-082	28,30
SS 216	TAKA	Alu/Black	12x7	5+2	4/110	74-1040	125,10	74-082	28,30
SS 316	ETU	Alu/Black	12x7	5+2	4/110	74-1050	125,10	74-082	28,30
SS 316	TAKA	Alu/Black	12x7	5+2	4/110	74-1050	125,10	74-082	28,30
SS 312	ETU	Alu	12x7	5+2	4/110	74-1030	130,10	74-082	28,30
SS 312	ETU	Alu	12x7	5+2	4/110	74-1030	130,10	74-082	28,30
SS 212	ETU	Alu	12x7	5+2	4/110	74-0980	125,10	74-082	28,30
SS 212	ETU	Alu	12x7	5+2	4/110	74-0980	125,10	74-082	28,30
SS 212	ETU	Black	12x7	5+2	4/110	74-0990	125,10	74-082	28,30
SS 212	TAKA	Black	12x7	5+2	4/110	74-0990	125,10	74-082	28,30
SS 112	ETU	Alu	12x7	5+2	4/110	74-0960	120,10	74-082	28,30
SS 112	TAKA	Alu	12x7	5+2	4/110	74-0960	120,10	74-082	28,30
SD Beadlock	ETU	Alu	12x7	5+2	4/110	74-1060	174,00	74-082	28,30
SD Beadlock	TAKA	Alu	12x7	5+2	4/110	74-1060	174,00	74-082	28,30

14 tuumaa	Väri	Koko	Offset	Jako	Tuotenro	Hinta	Mutterisarja	Hinta	
SS 216	ETU	Alu/Black	14x7	5+2	4/110	74-1045	143,20	74-082	28,30
SS 216	TAKA	Alu/Black	14x7	5+2	4/110	74-1045	143,20	74-082	28,30
SS 316	ETU	Alu/Black	14x7	5+2	4/110	74-1055	143,20	74-082	28,30
SS 316	TAKA	Alu/Black	14x7	5+2	4/110	74-1055	143,20	74-082	28,30
SS212	ETU	Alu	14x6	4+2	4/110	74-1000	130,10	74-082	28,30
SS212	TAKA	Alu	14x8	5+3	4/110	74-1001	137,30	74-082	28,30
SS212	ETU	Black	14x6	4+2	4/110	74-1010	130,10	74-082	28,30
SS212	TAKA	Black	14x8	5+3	4/110	74-1011	137,30	74-082	28,30
SD Dual	ETU	Alu	14x7	5+2	4/110	74-1070	280,00	74-082	28,30
SD Dual	TAKA	Alu	14x7	5+2	4/110	74-1070	280,00	74-082	28,30

15 tuumaa	Väri	Koko	Offset	Jako	Tuotenro	Hinta	Mutterisarja	Hinta	
SS212	ETU	Alu	15x7	5+2	4/110	74-1076	157,30	74-082	28,30
SS212	TAKA	Alu	15x7	5+2	4/110	74-1076	157,30	74-082	28,30

Jako 4/115, Offset 5+2/5+2

Arctic Cat

- Arctic Cat 300i/400i/500i/650i/700i/1000 2x4/4x4 '02-14
- Arctic Cat Wild Cat 12-14 (14" OEM)
- Arctic Cat Prowler 12-14 (14" OEM)

12 tuumaa	Väri	Koko	Offset	Jako	Tuotenro	Hinta	Mutterisarja	Hinta	
SS 216	ETU	ALU/BLACK	12x7	5+2	4/115	74-1042	125,10	74-082	28,30
SS 216	TAKA	ALU/BLACK	12x7	5+2	4/115	74-1042	125,10	74-082	28,30
SS 316	ETU	ALU/BLACK	12x7	5+2	4/115	74-1052	125,10	74-082	28,30
SS 316	TAKA	ALU/BLACK	12x7	5+2	4/115	74-1052	125,10	74-082	28,30
SS312	ETU	Alu	12x7	5+2	4/115	74-1032	130,10	74-082	28,30
SS312	TAKA	Alu	12x7	5+2	4/115	74-1032	130,10	74-082	28,30
SS212	ETU	Alu	12x7	5+2	4/115	74-0982	125,10	74-082	28,30
SS212	TAKA	Alu	12x7	5+2	4/115	74-0982	125,10	74-082	28,30
SS212	ETU	Black	12x7	5+2	4/115	74-0992	125,10	74-082	28,30
SS212	TAKA	Black	12x7	5+2	4/115	74-0992	125,10	74-082	28,30

14 tuumaa	Väri	Koko	Offset	Jako	Tuotenro	Hinta	Mutterisarja	Hinta	
SS 216	ETU	ALU/BLACK	14x7	5+2	4/115	74-1047	143,20	74-082	28,30
SS 216	TAKA	ALU/BLACK	14x7	5+2	4/115	74-1047	143,20	74-082	28,30
SS 316	ETU	ALU/BLACK	14x7	5+2	4/115	74-1057	143,20	74-082	28,30
SS 316	TAKA	ALU/BLACK	14x7	5+2	4/115	74-1057	143,20	74-082	28,30
SD Dual	ETU	Alu	14x7	5+2	4/115	74-1072	280,00	74-082	28,30
SD Dual	TAKA	Alu	14x7	5+2	4/115	74-1072	280,00	74-082	28,30

15 tuumaa	Väri	Koko	Offset	Jako	Tuotenro	Hinta	Mutterisarja	Hinta	
SS212	ETU	ALU	15x7	5+2	4/110	74-1077	157,30	74-082	28,30
SS212	TAKA	ALU	15x7	5+2	4/110	74-1077	157,30	74-082	28,30



SS 216



SS 316



Vanteet ja renkaat



Talvituotteet



Vinsit



Laukut ja tuulisuojat



Sähköosat



Jousitus ja voimansiirto



Pakoputket ja suutinsarjat



Ohjaus



Rungon osat ja peitteet



Jarrupalat ja rattaat



Moottori



Variaattorin osat



Maatalous-tarvikkeet



Kärryt ja reet

ATV





MÖNKIJÄ JA VANNE SUOSITUKSET: HYÖTY



Jako 4/137, Offset 4+3/4+3

Can-Am/Bombardier

- Can-Am/Bombardier Outlander 330/400/500/650/800/1000 '03-14
- Can-Am/Bombardier Renegade 500/800 '08-14
- Can-Am/Bombardier Commander/Maverick 800/1000 '11-14



SS 216



SS 316



12 tuumaa	Väri	Koko	Offset	Jako	Tuotenro	Hinta	Mutterisarja (16kpl)	Hinta	
SS 216	ETU	ALU/BLACK	12x7	5+2	4/137	74-1043	125,10	74-082	28,30
SS 216	TAKA	ALU/BLACK	12x7	5+2	4/137	74-1043	125,10	74-082	28,30
SS 316	ETU	ALU/BLACK	12x7	5+2	4/137	74-1053	125,10	74-082	28,30
SS 316	TAKA	ALU/BLACK	12x7	5+2	4/137	74-1053	125,10	74-082	28,30
SS312	ETU	ALU	12x7	5+2	4/137	74-1033	130,10	74-093	28,30
SS312	TAKA	ALU	12x7	5+2	4/137	74-1033	130,10	74-093	28,30
SS212	ETU	ALU	12x7	5+2	4/137	74-0982	125,10	74-093	28,30
SS212	TAKA	ALU	12x7	5+2	4/137	74-0982	125,10	74-093	28,30
SS212	ETU	BLACK	12x7	5+2	4/137	74-0993	125,10	74-093	28,30
SS212	TAKA	BLACK	12x7	5+2	4/137	74-0993	125,10	74-093	28,30
SD Beadlock	ETU	ALU	12x7	4+3	4/137	74-1063	174,00	74-093	28,30
SD Beadlock	TAKA	ALU	12x7	4+3	4/137	74-1063	174,00	74-093	28,30

14 tuumaa	Väri	Koko	Offset	Jako	Tuotenro	Hinta	Mutterisarja	Hinta	
SS 216	ETU	ALU/BLACK	14x7	5+2	4/137	74-1048	143,20	74-082	28,30
SS 216	TAKA	ALU/BLACK	14x7	5+2	4/137	74-1048	143,20	74-082	28,30
SS 316	ETU	ALU/BLACK	14x7	5+2	4/137	74-1058	143,20	74-082	28,30
SS 316	TAKA	ALU/BLACK	14x7	5+2	4/137	74-1058	143,20	74-082	28,30
SS212	ETU	ALU	14x6	4+2	4/137	74-1004	130,10	74-093	28,30
SS212	TAKA	ALU	14x8	5+3	4/137	74-1005	137,20	74-093	28,30
SS212	ETU	BLACK	14x6	4+2	4/137	74-1014	130,10	74-093	28,30
SS212	TAKA	BLACK	14x8	5+3	4/137	74-1015	137,20	74-093	28,30
SD Dual	ETU	ALU	14x7	4+3	4/137	74-1073	280,00	74-093	28,30
SD Dual	TAKA	ALU	14x7	4+3	4/137	74-1073	280,00	74-093	28,30

15 tuumaa	Väri	Koko	Offset	Jako	Tuotenro	Hinta	Mutterisarja	Hinta	
SS212	Etu	ALU	15x7	5+2	4/137	74-1078	157,30	74-093	28,30
SS212	Taka	ALU	15x7	5+2	4/137	74-1078	157,30	74-093	28,30



ATV

MÖNKIJÄ JA VANNE SUOSITUKSET: HYÖTY



Jako 4/156, Offset 4+3/4+3

Polaris	Mutterisarja	Polaris	Mutterisarja
• Polaris 335 Sportsman '99-06	74-086	• Polaris Ranger 4x4 '03-14	74-086
• Polaris 400/450 Sportsman '01-14	74-086	• Polaris RZR '08-14	74-086
• Polaris 500 Sportsman '96-14	74-086	• Polaris 550XP '09-14 ** (14" Oem)	74-082
• Polaris 500 Magnum '02-06	74-086	• Polaris 850XP '09-14 ** (14" Oem)	74-082
• Polaris 600 Sportsman '03-10	74-086	• Polaris Scrambler 850/1000 XP 09-14	74-082
• Polaris 700 Sportsman '02-10	74-086	• Polaris Ranger 900 XP 2013-	74-085
• Polaris 800 Sportsman '05-14	74-086	• Polaris RZR XP 1000 2014-	74-085
• Polaris Ace Sportsman '14	74-086		

12 tuumaa	Väri	Koko	Offset	Jako	Tuotenumero	Hinta	Mutterisarja (16kpl)	Hinta	
SS 216	ETU	ALU/BLACK	12x7	5+2	4/156	74-1044	125,10	ks. taulukko yllä	28,30
SS 216	TAKA	ALU/BLACK	12x7	5+2	4/156	74-1044	125,10		28,30
SS 316	ETU	ALU/BLACK	12x7	5+2	4/156	74-1054	125,10		28,30
SS 316	TAKA	ALU/BLACK	12x7	5+2	4/156	74-1054	125,10		28,30
SS312	ETU	ALU	12x7	4+3	4/156	74-1034	130,10		28,30
SS312	TAKA	ALU	12x7	4+3	4/156	74-1034	130,10		28,30
SS212	ETU	ALU	12x7	4+3	4/156	74-0985	125,10		28,30
SS212	TAKA	ALU	12x7	4+3	4/156	74-0985	125,10		28,30
SS212	ETU	BLACK	12x7	4+3	4/156	74-0995	125,10		28,30
SS212	TAKA	BLACK	12x7	4+3	4/156	74-0995	125,10		28,30
SD Beadlock	ETU	ALU	12x7	4+3	4/156	74-1065	174,00		28,30
SD Beadlock	TAKA	ALU	12x7	4+3	4/156	74-1065	174,00		28,30
14 tuumaa	Väri	Koko	Offset	Jako	Tuotenumero	Hinta	Mutterisarja (16kpl)	Hinta	
SS 216	ETU	ALU/BLACK	14x7	5+2	4/156	74-1049	143,20	ks. taulukko yllä	28,30
SS 216	TAKA	ALU/BLACK	14x7	5+2	4/156	74-1049	143,20		28,30
SS 316	ETU	ALU/BLACK	14x7	5+2	4/156	74-1059	143,20		28,30
SS 316	TAKA	ALU/BLACK	14x7	5+2	4/156	74-1059	143,20		28,30
SS212	ETU	ALU	14x6	4+2	4/156	74-1007	130,10		28,30
SS212	TAKA	ALU	14x8	5+3	4/156	74-1008	137,20		28,30
SS212	ETU	BLACK	14x6	4+2	4/156	74-1017	130,10		28,30
SS212	TAKA	BLACK	14x8	5+3	4/156	74-1018	137,20		28,30
SD Dual	ETU	Alu	14x7	4+3	4/156	74-1075	280,00		28,30
SD Dual	TAKA	Alu	14x7	4+3	4/156	74-1075	280,00		28,30
15 tuumaa	Väri	Koko	Offset	Jako	Tuotenumero	Hinta	Mutterisarja	Hinta	
SS212	Etu	ALU	15x7	5+2	4/156	74-1079	157,30	ks. taulukko yllä	28,30
SS212	Taka	ALU	15x7	5+2	4/156	74-1079	157,30		28,30

QUAD-VANTEET



T-9 PRO alumiinivanne

Näyttävät alumiinivanteet edulliseen hintaan.

8"					
74-0886	8x8	4/110	3+5	73,10	
74-0887	8x8	4/115	3+5	73,10	
74-0888	8x8	4/100	3+5	73,10	
9"					
74-0882	9x9	4/110	3+6	104,70	
74-0883	9x9	4/115	3+6	104,70	
74-0884	9x9	4/137	3+6	104,70	
10"					
74-0889	10x5	4/110	3+2	104,70	
74-0880	10x5	4/144	4+1	104,70	
74-0881	10x5	4/156	4+1	104,70	
74-0895	10x7	4/144	4+3	104,70	
74-0885	10x8	4/110	3+5	110,70	
74-0890	10x8	4/115	3+5	110,70	
74-0891	10x8	4/137	3+5	110,70	
74-0892	10x8	4/156	3+5	110,70	
74-0879	10x8	4/4	3+5	110,70	
74-0893	10x10	4/110	5+5	110,70	
74-0894	10x10	4/115	5+5	110,70	



T-9 PRO BAJA alumiinivanne

Näyttävät ja kestävät alumiinivanteet todella edulliseen hintaan. Vertaa kevyttä ja hintaa. Parempaa yhtälöä on vaikea saavuttaa.

8"				Ovh.
74-0900	8x8,5	4/110	3+5,5	159,50
74-0901	8x8,5	4/115	3+5,5	159,50
9"				Ovh.
74-0902	9x9	4/110	3+6	173,50
74-0903	9x9	4/115	3+6	173,50
74-0904	9x9	4/137	3+6	173,50
10"				Ovh.
74-0905	10x5	4/144	3+2	182,90
74-0906	10x5	4/156	3+2	182,90
74-0907	10x8	4/110	3+5	186,00
74-0908	10x8	4/115	3+5	186,00
74-0909	10x8	4/137	3+5	186,00
74-0910	10x8	4/156	3+5	186,00

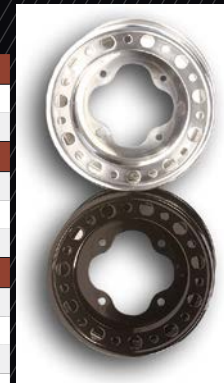

Vanteet ja renkaat



Talvituet



Vinsit



Laukut ja tuulisuojat



Sähköosat



Jousitus ja voimansiirto



Pakoputket ja suutinsarjat



Ohjaus



Rungon osat ja peitteet



Jarrupalat ja rattaat



Moottori



Variaattorin osat



Maatalous-tarvikkeet



Kärryt ja reet

ATV





Vanteet ja renkaat



Talvituotteet



Vinssit



Laukut ja tuulisuojat



Sähköosat



Jousitus ja voimansiirto



Pakoputket ja suutinsarjat



Ohjaus



Rungon osat ja peitteet



Jarrupalat ja rattaat



Moottori



Variaattorin osat



Maatalous-tarvikkeet



Kärryt ja reet



HYÖTYKÄYTTÖ

E = tieliikennehyväksytyt

Yhdysvaltalainen ITP on maailman myydyin mönkijöiden rengasmerkki ja sen renkaat ovat voittaneet lukuisia testejä ympäri maailman. ITP:n työntekijät ovat intohimoisia ATV-kuskeja. Parhaat ideat syntyvätkin usein käytännön tilanteissa.



MAMMOTH MAYHEM

uutuus!

MAMMOTH MAYHEM (50MM)

Uusi, korkea 32-tuumainen rengas, joka on varustettu erikoiskorkealla 50 mm harjalla. Mitoistaan huolimatta kevyt ja kestävä. Rengaskuvio ja harja takaavat pidon vaikeammassakin maastossa tarjoaa petomaista pitoa pehmeällä alustalla. Mayhem-sarjasta tuttu rengaskuvio rullaa ketterästi myös helpommassa maastossa.

32-tuumainen uutuus!

Tuotenumero	Koko	Hinta
74-0557	32x10-14	332,00



MONSTER MAYHEM

MONSTER MAYHEM (44MM)

Uusi, korkea 30-tuumainen rengas, joka tarjoaa petomaista pitoa pehmeällä alustalla. Mayhem-sarjasta tuttu rengaskuvio rullaa ketterästi myös helpommassa maastossa. Brutaali harja nousee 44 mm:iin asti.

30-tuumainen rengas!

Tuotenumero	Koko	Hinta
74-0555	30x9-14 44mm	284,50
74-0556	30x10-14 44mm	278,00



MEGA MAYHEM

MEGA MAYHEM (38MM)

Mega Mayhem on pikkuveljeään ITP Mayhemia vielä ärhäkkäämpi. Urasyyvyys on 38mm eli rengas pureutuu maastoon erittäin hyvällä pidolla. Renkaan kuvio käyttäytyy parhaiten kovilla alustoilla. 6-kankaisuus tuo renkaalle poikkeuksellisen hyvän kiihtyvyyden, jarrutusominaisuudet ja tasapainon. Kestävyys omaa luokkaansa. Valmistettu USA:ssa.

Urasyyvyys 38 mm, aggressiiviseen makuun!

Tuotenumero	Koko	Hinta
74-0533	27x9-12	194,10
74-0534	27x11-12	204,70
74-0535	28x9-12	221,30
74-0536	28x11-12	228,90
74-0537	27x9-14	214,30
74-0538	27x11-14	218,50
74-0539	28x9-14	230,40
74-0540	28x11-14	233,90



MAYHEM

MAYHEM (26MM)

Vaihtoehto aggressiivisempaan makuun. Kykyä ja asennetta, jolla erotut joukosta! Valmistettu USA:ssa.

Tuotenumero	Koko	Hinta
74-0531	26x9-12	177,50
74-0532	26x11-12	196,10

ATV

RENKAAT HYÖTYKÄYTTÖ



MUD LITE AT (19MM)

Markkinoiden paras rengas ja testivoittaja USA:ssa. Ylivoimaisesti luokan kevyin rengas uskomattomalla purevalla pidolla. Yleisrengas, joka toimii erilaisilla alustoilla. Vahva rakenne, 6-kankainen.

Tuotenumero	Koko	Harja		Hinta
74-0471	22x11.00-8	19 mm	6-ply	138,70
74-0472	25x12.00-9	19 mm	6-ply	157,80
74-0473	22x8.00-10	19 mm	6-ply	116,50
74-0519	22x11.00-10	19 mm	6-ply	144,20
74-0520	23x8.00-10	19 mm	6-ply	121,50
74-0521	23x10.00-10	19 mm	6-ply	135,60
74-0522	24x11.00-10	19 mm	6-ply	144,70
74-0523	25x11.00-10	19 mm	6-ply	156,80
74-0474	27x12.00-10	19 mm	6-ply	221,30
74-0475	23x8.00-11	19 mm	6-ply	120,00
74-0468	24x8.00-11	19 mm	6-ply	125,60
74-0476	24x9.00-11	19 mm	6-ply	135,10
74-0469	24x10.00-11	19 mm	6-ply	147,20
74-0477	25x10.00-11	19 mm	6-ply	154,00
74-0478	25x8.00-12	19 mm	6-ply	121,50
74-0479	25x10.00-12	19 mm	6-ply	144,20
74-0467	24x8.00-12	19 mm	6-ply	131,60



MUD LITE

Markkinoiden myydyimmät!

MUD LITE XL (29MM)

Kuten Mud Lite AT, mutta korkeammalla harjalla.

Tuotenumero	Koko	Harja	Vahvuus	Hinta
74-0524	25x10.00-12	29 mm	6-ply	168,40
74-0525	25x12.00-12	29 mm	6-ply	182,00
74-0470	26x9.00-12	29 mm	6-ply	168,90
74-0480	26x10.00-12 E	29 mm	6-ply, E-hyv.	166,40
74-0481	26x12.00-12 E	29 mm	6-ply, E-hyv.	187,10
74-0526	27x9.00-12	29 mm	6-ply	185,00
74-0484	27x10.00-12	29 mm	6-ply	196,60
74-0485	27x12.00-12	29 mm	6-ply	206,20
74-0482	28x10.00-12	29 mm	6-ply	217,80
74-0483	28x12.00-12	29 mm	6-ply	232,90
74-0515	27x10.00-14	29 mm	6-ply	210,70
74-0516	27x12.00-14	29 mm	6-ply	219,80
74-0517	28x10.00-14	29 mm	6-ply	226,40
74-0518	28x12.00-14	29 mm	6-ply	233,90



MUD LITE XL

MUD LITE XXL (31MM)

30-tuumainen, markkinoiden suurin rengas Mud liten ominaisuuksilla. Vahva rakenne, 6-kankainen.

Tuotenumero	Koko	Harja	Vahvuus	Hinta
74-0489	30x10.00-12	31 mm	6-ply	286,90
74-0490	30x12.00-12	31 mm	6-ply	317,10
74-0491	30x10.00-14	31 mm	6-ply	312,60
74-0492	30x12.00-14	31 mm	6-ply	333,20



MUD LITE XXL

MUD LITE XTR (29MM)

XTREME TRAIL RIDE. Kevyt ja pitävin rengas vaativaan käyttöön. Radiaali-rengas aggressiivisella kuviolla. Vahva rakenne, 6-kankainen.

Tuotenumero	Koko	Harja		Hinta
74-0567	26x9.00-12	29 mm	6-ply	237,00
74-0568	26x11.00-12	29 mm	6-ply	264,70
74-0498	27x9.00-12	29 mm	6-ply	258,60
74-0499	27x11.00-12	29 mm	6-ply	283,80
74-0486	27x9.00-14	29 mm	6-ply	268,70
74-0487	27x11.00-14	29 mm	6-ply	294,40



MUD LITE XTR



Vanteet ja renkaat



Talvituotteet



Vinsit



Laukut ja tuulisuojat



Sähköosat



Jousitus ja voimansiirto



Pakoputket ja suutinsarjat



Ohjaus



Rungon osat ja peitteet



Jarrupalat ja rattaat



Moottori



Variaattorin osat



Maataloustarvikkeet



Kärkyt ja reet

ATV



HYÖTYKÄYTTÖ

E = tieliikennehyväksytty



BLACK WATER EVOLUTION

BLACK WATER EVOLUTION RADIAL (26MM)

Black Water Evolution on aivan uudentyyppinen rengas, asettaen uudet standardit jatkuvasti kasvavalle UTV-segmentille. Harja 26mm. 8-kankainen. Uudentyyppinen pinta kuvioineen ja "Tough Tread" -kumiseos tuo erinomaisen pidon pitäen samalla ajon sulavana ja tasapainoisena. Reunat erikoisvahvistettu. Valmistettu USA:ssa.

8-kankainen radiaalirengas, nyt myös 30-tuumaisena!

Tuotenumero	Koko	Hinta
74-0543	25x9R-12	234,40
74-0544	25x11R-12	253,10
74-0545	26x9R-12	247,50
74-0546	26x11R-12	261,70
74-0547	27x9R-12	270,70
74-0548	27x11R-12	296,90
74-0549	27x9R-14	281,80
74-0550	27x11R-14	309,00
74-0551	30x10R-12	327,00
74-0552	30x10R-14	330,50
74-0553	30x10R-15	320,50



ULTRACROSS (16MM)

Kovempien pintojen rengas, jossa erittäin pieni vierintävastus. Harja 16mm.

15-tuumainen!

Tuotenumero	Koko	Hinta
74-0530	27x10R-15	276,80



TERRACROSS R/T RADIAL (20MM)

Kestävä Radiaali-rengas erinomaisilla ajo-ominaisuuksilla vaikkapa UTV-käyttöön. Harja 20mm. Vahva rakenne, 6-kankainen. Reunat erikoisvahvistettu (7-kankaiset).

Tuotenumero	Koko	Hinta
74-0500	25x8R-12 E	213,30
74-0501	25x10R-12 E	231,90
74-0502	26x9R-12	221,80
74-0503	26x11R-12	272,70
74-0511	26x8R-14	227,40
74-0527	26x9R-14	233,90
74-0512	26x11R-14	258,10



900XCT

900XCT RADIAL (22MM)

Vankka 6-kankainen radial-rakenne kestää ja antaa tasapainoisen ajotuntuman. Rengaskuvio antaa paljon pitoa, mutta tarjoaa silti sulavan ja hiljaisen ajokokemuksen.

Tuotenumero	Tuote	Hinta
74-0541	27x9R-12	199,20
74-0542	27x11R-12	242,50



Vanteet ja renkaat



Talvutuotteet



Vinssit



Laukut ja tuulisuojat



Sähköosat



Jousitus ja voimansiirto



Pakoputket ja suutinsarjat



Ohjaus



Rungon osat ja peitteet



Jarrupalat ja ratat



Moottori



Variaattorin osat



Maatalous-tarvikkeet



Kärryt ja reet

ATV

MAXXIS®

HYÖTYKÄYTTÖ

HUOM! #E = E-tieliikennehyväksytyt.

MU01 Zilla™ (eteen)

Tuotenumero	Renkaan koko	Harja (mm)		Hinta
74-8208	25 x 8,00 - 12	18	6 Pr 43J #E	122,00
74-8210	26 x 9,00 - 12	30	6 Pr 49J #E	144,50
74-8212	27 x 9,00 - 12	30	6 Pr 52J #E	157,50
74-8214	28 x 10,00 - 12	30	6 Pr 56J #E	191,50
74-8216	26 x 9,00 - 14	30	6 Pr 45J #E	170,50
74-8218	27 x 10,00 - 14	30	6 Pr 53J #E	219,00
74-8220	28 x 9,00 - 14	30	6 Pr 50J #E	206,00
74-8222	30 x 9,00 - 14	30	6 Pr 57J #E	242,50

MU02 Zilla™ (taakse)

Tuotenumero	Renkaan koko	Harja (mm)		Hinta
74-8209	25 x 10,00 - 12	18	6 Pr 50J #E	154,50
74-8211	26 x 11,00 - 12	30	6 Pr 55J #E	178,50
74-8213	27 x 11,00 - 12	30	6 Pr 56J #E	186,00
74-8215	28 x 12,00 - 12	30	6 Pr 61J #E	199,50
74-8217	26 x 11,00 - 14	30	6 Pr 52J #E	201,00
74-8219	27 x 12,00 - 14	30	6 Pr 59J #E	241,00
74-8221	28 x 11,00 - 14	30	6 Pr 58J #E	241,50
74-8223	30 x 11,00 - 14	30	6 Pr 62J #E	296,50



Maxxis Zilla™

Jos etsit erinomaista pitoa hyvillä ajo-ominaisuuksilla, Zilla™ on valintasi. Kevyt ja nopea Zilla™ takaa tasaisen ajotuntuman hyvinkin vaikeassa maastossa.



M966 Mudzilla™

Äärimmäinen rengas pehmeille alustoille. Mudzillan™ aggressiivinen rengaskuvio pureutuu paksunkin mutakerroksen läpi ja pureutuu maaperään jyrkilläkin alustoilla.

Tuotenumero	Renkaan koko	Harja (mm)		Hinta
74-8250	26 x 9,00 - 12	33	6 Pr	236,00
74-8251	26 x 12,00 - 12	33	6 Pr	286,00
74-8252	27 x 9,00 - 12	35,5	6 Pr	241,50
74-8253	27 x 12,00 - 12	35,5	6 Pr	299,00
74-8255	28 x 10,00 - 12	38	6 Pr	267,50
74-8256	28 x 12,00 - 12	38	6 Pr	301,50
74-8257	30 x 9,00 - 14	38	6 Pr	324,00
74-8258	30 x 11,00 - 14	38	6 Pr	370,00



M-961 Mudbug™

Mud Bug™ on varustettu korkealla harjalla (30 mm). Auramainen, korkea rengaskuvio ohjaa pehmeän maa-aineksen pois renkaan tieltä ja takaa näin tasaisen hyvän pidon erilaisilla alustoilla.

	Tuotenumero	Renkaan koko	Harja (mm)		Hinta
Eteen	74-8138	26 x 10,00 - 12	30	6 Pr	207,50
	74-8140	27 x 10,00 - 12	30	6 Pr	210,00
	74-8142	28 x 10,00 - 12	30	6 Pr	213,00
Taakse	74-8139	26 x 12,00 - 12	30	6 Pr	231,00
	74-8141	27 x 12,00 - 12	30	6 Pr	232,00
	74-8143	28 x 12,00 - 12	30	6 Pr	236,00



Vanteet ja renkaat



Talvituoitteet



Vinsit



Laukut ja tuulisuojat



Sähköosat



Jousitus ja voimansiirto



Pakoputket ja suutinsarjat



Ohjaus



Rungon osat ja peitteet



Jarrupalat ja rattaat



Moottori



Variaattorin osat



Maatalous-tarvikkeet



Kärryt ja reet

ATV

MAXXIS®



M917 Bighorn™ Radial (eteen)

Tuotenumero	Renkaan koko	Harja (mm)		Hinta
74-8150	25 x 8,00 - R12	22	6 Pr #E	189,00
74-8152	26 x 9,00 - R12	20	6 Pr #E	214,50
74-8154	27 x 9,00 - R12	20	6 Pr #E	228,50

M918 Bighorn™ Radial (taakse)

Tuotenumero	Renkaan koko	Harja (mm)		Hinta
74-8151	25 x 10,00 - R12	22	6 Pr #E	223,00
74-8153	26 x 12,00 - R12	20	6 Pr #E	246,50
74-8155	27 x 12,00 - R12	20	6 Pr #E	275,50

Maxxis Bighorn™ Radial

uutuus!

Leveällä kuviolla varustettu radiaalirengas antaa erinomaisen pidon. Bighorn™ on vankka ja kestävä vaihtoehto lyhyille ja pidemmillekin seikkailuille.



MU15 VIPR™ eteen

Tuotenumero	Renkaan koko	Harja (mm)		Hinta
74-8160	25 x 8,00 - R12	22	6 Pr	189,00
74-8162	27 x 9,00 - R14	26	6 Pr	271,50

MU15 VIPR™ taakse

Tuotenumero	Renkaan koko	Harja (mm)		Hinta
74-8161	25 x 10,00 - R12	22	6 Pr	221,50
74-8163	27 x 11,00 - R14	26	6 Pr	309,50

Maxxis VIPR™

uutuus!

Luotettava vyörengas aggressiiviseen ajoon tavallisiin ja side-by-side-mönkijöihin. Karkealla rengaskuviolla varustettu Vipr™ selvittää haasteet raskaammallakin kuormalla ajettaessa.



M-9208 Sur Trak

Tuotenumero	Renkaan koko	Harja (mm)		Hinta
74-8123	25 x 8,00 - 12	18	2 Pr #E	138,00
74-8125	25 x 10,00 - 12	18	2 Pr #E	150,00



Vanteet ja renkaat



Talvituotteet



Vinssit



Laukut ja tuulisuojat



Sähköosat



Jousitus ja voimansiirto



Pakoputket ja suutinsarjat



Ohjaus



Rungon osat ja peitteet



Jarrupalat ja rattaat



Moottori



Variaattorin osat



Maatalous-tarvikkeet



Kärryt ja reet

ATV

HYÖTYKÄYTTÖ



Sun F. A-33 (22mm)

Monipuolinen 6-kankainen all-round rengas.

Tuotenro	Renkaan koko		Hinta
74-0583	25x8.00-12	6-ply, E-Hyv.	110,00
74-0584	25x10.00-12	6-ply, E-Hyv.	134,00
74-0570	26x9.00-12	6-ply, E-Hyv.	135,10
74-0571	26x11.00-12	6-ply, E-Hyv.	150,30
74-0572	27x9.00-14	6-ply, E-Hyv.	143,20
74-0573	27x11.00-14	6-ply, E-Hyv.	168,40



Sun F. A-40 (25mm)

Monipuolinen 6-kankainen all-round rengas.

Tuotenro	Renkaan koko		Hinta
74-0585	26x9.00-12	6-ply, E-hyv.	136,00
74-0586	26.11.00-12	6-ply, E-hyv.	158,00



HYÖTYKÄYTTÖ



C-828



Tuotenro	Renkaan koko	Harja (mm)		Hinta
74-8102	22 x 8,00 - 10	10,5	4 Pr #E	96,50



C-829



Tuotenro	Renkaan koko	Harja (mm)		Hinta
74-8064	145/70-6	5,5	2 Pr #E	32,00
74-8074	16 x 8,00 - 7	10	2 Pr #E	49,50
74-8083	20 x 7,00 - 8	8,5	2 Pr #E	73,00



Vanteet ja renkaat



Talvituotteet



Vinsit



Laukut ja tuulisuojat



Sähköosat



Jousitus ja voimansiirto



Pakoputket ja suutinsarjat



Ohjaus



Rungon osat ja peitteet



Jarrupalat ja rattaat



Moottori



Variaattorin osat



Maatalous-tarvikkeet



Kärkyt ja reet

ATV





Vanteet ja renkaat



Talvituotteet



Vinssit



Laukut ja tuulisuojat



Sähköosat



Jousitus ja voimansiirto



Pakoputket ja suutinsarjat



Ohjaus



Rungon osat ja peitteet



Jarrupalat ja rattaat



Moottori



Variaattorin osat



Maatalous-tarvikkeet



Kärryt ja reet



MAANTIEKÄYTTÖ

HUOM! #E = E-tieliikennehyväksytty.



M991 Spearz (eteen)

E-Tieliikenne hyväksytty

Tuote nro.	Koko		Hinta
74-8242	25 x 8,00 - 12	4 Pr #E	138,00



M992 Spearz (taakse)

E-Tieliikenne hyväksytty

Tuote nro.	Koko		Hinta
74-8243	25 x 10,00 - 12	4 Pr #E	164,00



C-9272 Eturengas

E-Tieliikenne hyväksytty

Tuote nro.	Koko		Hinta
74-8540	19 x 7,00 - 8	#E	73,00
74-8546	175/70-10 (21x7-10)	#E	95,50



C-9273 Takarengas

E-Tieliikenne hyväksytty

Tuotenro	Renkaan koko		Hinta
74-8518	225/40-10 (18x10-10)	#E	101,50
74-8520	255/60-10 (22x10-10)	#E	117,00

MAANTIEKÄYTTÖ



Sun.F A-021

6-Kankainen tieliikenne-hyväksytty rengas kaikkeen maantiekäyttöön.

Tuotenro				Hinta
74-0581	A-021	25x8-12	Eteen	93,80
74-0582	A-021	25X10-12	Taakse	113,00



ATV



SPORT

ITP tarjoaa urheilukäyttöön paljon eri vaihtoehtoja. Alla olevasta taulukosta näet kunkin rengastyypin sopivuuden eri tarkoituksiin.

ATV Sport käyttötarkoitus	Kivinen/ kova alusta	Muta/ suo	Yleis/har- rastus	Metsä	MX kova	MX keski- kova	MX pehmeä
Quadcross MX PRO							
Holeshot SX							
Holeshot MXR6							
Holeshot (STD.)							
Holeshot XCT							
Holeshot H-D							
Holeshot GNCC							



QUADCROSS MX PRO

QUADCROSS MX PRO

Erityisesti kovan alustan rengas, Uusi profilli parantaa erityisesti kaarrepitoa. Uusi pehmeämpi kumiseos tuo pitoa kiihdytyksiin ja jarrutuksiin liukkaammilla alustoilla. Kehitetty yhteistyössä Yamahan ja Kawasakin tehdastiimin kanssa.

Tuotenumero	Tuote	Hinta
74-0436	ITP QUADCROSS MX PRO 20x6-10	147,20
74-0437	ITP QUADCROSS MX PRO 18x10-8	166,40



HOLESHOT STD

HOLESHOT STD

Tästä rengasmallista on tehty valtavasti jäljitelmiä - valitse siis alkuperäinen, älä tyydy vähempään. Patentoitu, äärimmäisen toimiva rengaskuvio.

Tuotenumero	Tuote	Hinta
74-0440	ITP HOLESHOT 20x11.00-8 4-PLY	152,30
74-0441	ITP HOLESHOT 20x11.00-9 4-PLY	152,30
74-0442	ITP HOLESHOT 20x11.00-10 4-PLY	152,30
74-0443	ITP HOLESHOT 21x7.00-10 2-PLY	128,10



HOLESHOT MXR6

HOLESHOT MXR6

Vahvistettu, hiotulla tunteella varustettu Holeshot™.

Tuotenumero	Tuote	Hinta
74-0430	ITP HOLESHOT MXR6 19x6.00-10	127,10
74-0431	ITP HOLESHOT MXR6 20x6.00-10	127,10
74-0432	ITP HOLESHOT MXR6 18x10.00-8	141,70
74-0433	ITP HOLESHOT MXR6 18x10.00-9	141,70



HOLESHOT GNCC

HOLESHOT GNCC

Erityisesti metsämaastoihin suunniteltu Holeshot™.

Tuotenumero	Tuote	Hinta
74-0450	ITP HOLESHOTGNCC 21x7.00-10	170,90
74-0447	ITP HOLESHOTGNCC 22x7.00-10	179,50
74-0448	ITP HOLESHOTGNCC 20x10.00-9	202,20
74-0449	ITP HOLESHOTGNCC 21x11.00-9	205,70



HOLESHOT SR

HOLESHOT SR

E-hyväksytty radiaalirengas, jolla voit ajaa myös yleisillä maanteillä.

Tuotenumero	Tuote	Hinta
74-0513	ITP HOLESHOT SR 21x7R-10 E-MARKED	147,20
74-0514	ITP HOLESHOT SR 20x10R-9 E-MARKED	176,50



Talvituotteet



Vinsit



Laukut ja tuulisuojat



Sähköosat



Jousitus ja voimansiirto



Pakoputket ja suutinsarjat



Ohjauksen



Rungon osat ja peitteet



Jarrupalat ja rattaat



Moottori



Variaattorin osat



Maataloustarvikkeet



Kärkyt ja reet

ATV



MÖNKIJÄN SISÄRENKAAT



Sisärenkaat ITP / Carlisle

Tuotenum	Tuote	Hinta	SOPIVUUDET		
			Renk. ulkohalkaisija	Renk. leveys	Vanteen koko
74-9620	ITP/CARLISLE AT21/22 x 11/12R8	22,20	18/19/20/21/22	8/9/10/11/12	8/9
74-9621	ITP/CARLISLE AT25 x 12R9	27,30	24/25/26	11/12/13,5	9/10
74-9622	ITP/CARLISLE AT20 x 8/10R10	25,30	18/19/20/21/22/23	7/8/9/10/11	10
74-9623	ITP/CARLISLE AT22/23 x 8R11/12	28,30	23/24/25	8/9/10	11/12
74-9624	ITP/CARLISLE ATV-TUBE AT24/26 x 12R12	30,30	24/25/26/27	10/11/12	12
74-9625	ITP/CARLISLE ATV-TUBE	22,20	26/27	8/9/10/11/12	14
74-9626	ATV-TUBE 215/225-14	23,00	27/28	9/10/11	14



Vanteet ja renkaat



Talvituotteet



Vinssit



Laukut ja tuulisuojat



Sähköosat



Jousitus ja voimansiirto



Pakoputket ja suutinsarjat



Ohjaus



Rungon osat ja peitteet



Jarrupalat ja ratat



Moottori



Variaattorin osat



Maatalous-tarvikkeet



Kärryt ja reet

MÖNKIJÄN SISÄRENKAAT

Sisärenkaat

Tuotenum	Tuote	Hinta
74-9600	145/70 - 6 TR13	10,00
74-9601	16 x 7,00/8,00 - 7 TR13	13,50
74-9602	20 x 7,00/9,00 - 8 TR13	15,50
74-9603	22 x 11,00 - 8 TR4	18,00
74-9610	22 x 11,00 - 9 TR6	20,00
74-9604	25 x 12,00 - 9 TR6	20,00
74-9611	22 x 8.00/9.00 - 10 TR13	19,50

Tuotenum	Tuote	Hinta
74-9606	22 x 10.00/11.00 - 10 TR13	20,50
74-9612	25 x 12,00 - 10 TR6	25,00
74-9607	24 x 9,00 - 11 TR6	21,50
74-9608	25 x 8,00/10,00 - 12 TR4	24,50

TL-renkaan paikkaussarja

Tuotenum	Tuote	Hinta
34-2785	TL-renkaan paikkaussarja	27,30
34-2786	TL-renkaan paikkaussarja	34,50
34-3050	Hiilihappopatruuna 16 g /2pak.	6,50
34-3051	Tiivistystulppa 10 kpl	4,30



34-2785



34-3051



34-2786

PYÖRÄSARJAT



76-006



76-005



Tuotenum.	Tuote	Hinta	
76-005-L	Rengas vasen vanteella MAIQILIN 22x12.00-8 (Tukkikärryyn)	92,00	
76-005-R	Rengas oikeavanteella MAIQILIN 22x12.00-8 (Tukkikärryyn)	92,00	
76-005-1	Rengas maiqilin 22x12.00-8 (Tukkikärryyn)	79,00	
76-006	Rengas vanteella maiqilin 22x11.00-8 (Maastokärryyn)	79,00	
76-006-1	Rengas maiqilin 22x11.00-8 (Maastokärryyn)	63,00	
76-039	Napa 35x200, Pyöreä	450kg	59,50
76-040	Napa 35x247, Neliskulmainen	500kg	68,60
77-12177-17	Navan Mutteri		1,85/kpl

LEVITYSPULTTISARJAT



Tuotenum	Tuote	Hinta
74-06510	VANTEEN LEVITYSPULTTISARJA (8kpl) 35/10mm 1,25	36,30
74-06510-1	VANTEEN LEVITYSPULTTISARJA (8kpl) 35/10mm 3/8-24	36,30



LEVIKEPALAT / SPACERIT

Tuotenumero	Tuote	Sopivuus	Ovh/ Pari
74-064110-1	Bronco, Levikepalat 1" 4/110	Honda, Suzuki, Yamaha	51,50
74-064110-2	Bronco, Levikepalat 2" 4/110	Honda, Suzuki, Yamaha	77,50
74-064115-1	Bronco, Levikepalat 1" 4/115	Arctic Cat	53,00
74-064115-2	Bronco, Levikepalat 2" 4/115	Arctic Cat	79,00
74-064136-1	Bronco, Levikepalat 1" 4/136	Can-Am	55,00
74-064136-2	Bronco, Levikepalat 2" 4/136	Can-Am	86,50
74-064156-1	Bronco, Levikepalat 1" 4/156 3/8-24"	Polaris	57,50
74-064156-2	Bronco, Levikepalat 2" 4/156 3/8-24"	Polaris	92,00
74-064156-11	Bronco, Levikepalat 1" 4/156	Polaris XP	57,50
74-064156-22	Bronco, Levikepalat 2" 4/156	Polaris XP	92,00

- Materiaali: ALU 6061-T6
- Myydään pareittain, Sisältää mutterit ja pultit



Vanteet ja renkaat



Talvituotteet



Vinsit



Laukut ja tuulisuojat



Sähköosat



Jousitus ja voimansiirto



Pakoputket ja suutinsarjat



Ohjaukset



Rungon osat ja peitteet



Jarrupalat ja rattaat



Moottori



Variaattorin osat



Maatalous-tarvikkeet



Kärryt ja reet

MUUT RENKAAT



HF-224/KT-302

LG-306

Kottikärryn renkaat

Tuotenumero	Tuote	Hinta
749-1022	DURO 4.00-4 HF-207	12,00
749-1044	DURO 4.00-6 HF-207	12,00
749-1054	DURO 4.80/4.00-8 HF-207	13,00



Ruohonleikkurin renkaat

Tuote nro	Tuote	Hinta
749-1403	11 x 4.00 - 4 KT-302	19,00
749-1406	11 x 4.00 - 5 KT-302	20,00
749-1418	13 x 5.00 - 6 HF-224	26,00
749-1421	13 x 6.50 - 6 KT-302	32,00
749-1429	15 x 6.00 - 6 HF-224	34,00
749-1438	16 x 6.50 - 8 HF-224	43,00
749-1454	16 x 7.50 - 8 HF-224	56,00
749-1458	18 x 6.50 - 8 HF-224	58,00
749-1459	18 x 7.00 - 8 C-872	82,00
749-1463	18 x 8.50 - 8 HF-224	68,00
749-1468	18 x 9.50 - 8 HF-224	68,00
749-1471	20 x 8.00 - 8 HF-224	77,00
749-1472	20 x 10.00 - 8 HF-224	84,00
749-1473	20 x 8.00 - 10 LG-306	91,00
749-1475	20 x 10.00 - 10 HF-224	98,00
749-1480	23 x 8.50 - 12 HF-224	112,00
749-1477	23 x 10.50 - 12 HF-224	133,00
749-1486	26 x 12.00 - 12 LG-306	170,00

Lumilingon rengas

Tuote nro	Tuote	Hinta
749-1301	4.10 - 4 HF-271	21,50
749-1302	4.10 - 6 HF-271	24,00
749-1303	13 x 5.00 - 6 HF-271	30,00
749-1304	14 x 4.00 - 6 HF-270	36,00
749-1305	4.80 - 8 HF-271	32,00
749-1306	16 x 6.50 - 8 HF-271	42,50



HF-270

HF-271

Puutarhakoneiden/kottikärryn sisärenkaat

Tuote nro	Tuote	Hinta
749-1810	3.50/4.00 - 4 TR87	5,50
749-1811	3.50/4.00 - 4 TR13	5,50
749-1820	3.50/4.00 - 6 TR13	5,50
749-1840	3.50/4.00 - 8 TR13	5,50
749-1867	11 x 4.00 - 4 TR87	6,50
749-1868	11 x 4.00 - 5 TR87	7,00
749-1870	13 x 5.00 - 6 TR13	8,00
749-1869	13 x 6.50 - 6 TR87	9,00

Tuote nro	Tuote	Hinta
749-1872	15 x 6.00 - 6 TR13	8,50
749-1875	16 x 6.50/7.50 - 8 TR13	10,00
749-1876	18 x 8.50/9.50 - 8 TR13	13,50
749-1877	20 x 8.00/10.00 - 8 TR13	13,50
749-1890	21 x 12.00 - 8 TR4	17,50
749-1879	20 x 8.00/10.00 - 10 TR13	14,00
749-1880	23 x 8.50/10.50 - 12 TR13	17,00

ATV



Like Wheels— Only Better



Vanteet ja renkaat



Talvituotteet



Vinssit



Laukut ja tuulisuojat



Sähköosat



Jousitus ja voimansiirto



Pakoputket ja suutinsarjat



Ohjaus



Rungon osat ja peitteet



Jarrupalat ja rattaat



Moottori



Variaattorin osat



Maatalous-tarvikkeet



Kärryt ja reet

ATV



TELASARJAT

camoplast
HI-PERFORMANCE TRACKS

Mönkijällä pääsee nyt paikkoihin, joiden olosuhteet olisivat renkaille liikaa. Kulkee reittisi sitten lumella tai mudassa, Camoplast telasarjat mahdollistavat vaivattoman liikkumisen maastossa kuin maastossa, ympäri vuoden.

Camoplastilla on vankka ja pitkä kokemus telasarjojen ja -mattojen valmistuksessa ja Camoplast asettaakin standardit koko alalle.

Telasarjoissa käytetään Flextrack-teknologiaa, jolloin ajaessa lentää merkittävästi vähemmän roiskeita, eikä lunta tai mutaa kerääny telastoon samalla tavalla kuin muilla valmistajilla.



Camoplast Tatou UTV T4S
Hlnta: 5840,-
sis kiinnityssarjan ja telarungot



Camoplast Tatou ATV T4S
Hlnta: 4690,-
sis kiinnityssarjan ja telarungot

Suorituskyky on yksityiskohdissa

camoplast

Ajaminen Camoplast-telasarjalla varustetulla mönkijälläsi vastaa pyörillä ajamista, muutamalla selvällä edulla.

- PAREMPI:**
- Maavara
 - Liikkuvuus
 - Vakaus
 - Pito
 - Kelluvuus

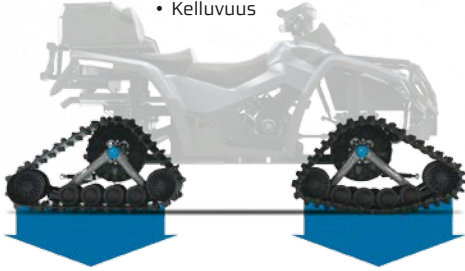

400 kg:n mönkijän (kuljettajan kanssa) keskimääräinen paine maahan pehmeällä alustalla on:

TELOILLA: 3,79 kPa
PYÖRILLÄ: 13,79 kPa

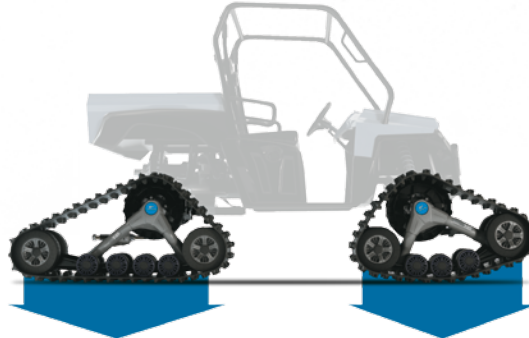

800 kg:n mönkijän (kuljettajan ja matkustajan kanssa) keskimääräinen paine maahan pehmeällä alustalla on:

TELOILLA: 6,82 kPa
PYÖRILLÄ: 26,89 kPa

TATOU ATV T4S

KESKIÖ

- Ulommat tiivisteet parantavat laakerien kestävyyttä
- Ruostumaton teräsvaippa vähentää huollontarvetta



Huom! Uusi matto ja uudet telapyörät

SISÄINEN VAIHDE

- Ainutlaatuinen ratkaisu ympärivuotiseen käyttöön
- Vähentää kitkaa
- Maksimoi tehosiirron kaikissa olosuhteissa
- Minimoi kuraroiskeet ja kerääntymisen

KAKSOISVAKAIN

- Painevisteessä
- Vaimentaa iskuja
- Tasaisempi ajo



TATOU UTV T4S

SISÄINEN VAIHDE

- Ainutlaatuinen ratkaisu ympärivuotiseen käyttöön
- Vähentää kitkaa
- Maksimoi tehosiirron kaikissa olosuhteissa
- Minimoi kuraroiskeet ja kerääntymisen



Huom! Uusi matto ja uudet telapyörät

KESKIÖ

- Ulommat tiivisteet parantavat laakerien kestävyyttä
- Ruostumaton teräsvaippa vähentää huollontarvetta

KAKSOISVAKAIMET

- Painevisteessä
- Vaimentaa iskuja
- Tasaisempi ajo



Vanteet ja renkaat



Talvituotteet



Vinsit



Laukut ja tuulisuojat



Sähköosat



Jousitus ja voimansiirto



Pakoputket ja suutinsarjat



Ohjaus



Rungon osat ja peitteet



Jarrupalat ja rattaat



Moottori



Variaattorin osat



Maatalous-tarvikkeet



Kärryt ja reet

ATV





SOPIVUUDET



- A= Tiettyä rajoituksia voi esiintyä
- B= Vaatii korotussarjan
- C= Vaatii tilapäisiä muutoksia muoviosiin
- D= Vaatii pysyviä muutoksia muoviosiin
- HW= Heavy Worker edition



HUOM! Muista tilata kiinnityssarja ja telarunko erikseen (ennen samalla tuotenumerolla)

CC	Arctic Cat	Takajousitus	Vuosimalli		Tatou T4S ATV Telasarjat		Tatou T4S UTV Telasarjat	
					Kiinnityssarja Tuotenr	Telarunkojen Tuotenr	Kiinnityssarja Tuotenr	Telarunkojen Tuotenr
300	(i) 4X4	Erillisjousitus	1999-2005		742-5000-01-0300	743-4242-NN-1516		
350	4X4	Erillisjousitus	-2012		742-5000-01-0366	743-4242-NN-1616		
366	4X4 / SE	Erillisjousitus	2008-2011		742-5000-01-0366	743-4242-NN-1616		
375	Automatic ACT	Jäykkäperä.	-2002		742-5000-01-3740	743-4342-NN-1515		
400	(i) 4X4	Erillisjousitus	2002-2003		742-5000-01-0401	743-4242-NN-1616		
400	Automatic TBX	Erillisjousitus	2004-2006	HW	742-5000-01-4410	743-4212-NN-1616		
400	(i) 4X4 Limited Edition	Erillisjousitus	2005-2007		742-5000-01-5600	743-4242-NN-1616		
400	TRV Automatic / Plus	Erillisjousitus	2007-2010		742-5000-01-5710	743-4242-NN-1616		
400	TRV CORE	Erillisjousitus	2013-2014		742-5000-01-4400	743-4242-NN-1616		
400	(i) 4X4	Erillisjousitus	-2004		742-5000-01-4400	743-4242-NN-1616		
400	CORE	Erillisjousitus	-2013		742-5000-01-0366	743-4242-NN-1616		
400		Erillisjousitus	-2014		742-5000-41-0001	743-4242-NN-1616		
400	Manual shift	Jäykkäperä.	1998-2001		742-5000-01-0400	743-4342-NN-1616		
400	Manual shift ACT	Jäykkäperä.	2002-2006		742-5000-01-3740	743-4342-NN-1515		
400	Automatic ACT	Jäykkäperä.	2003-2006		742-5000-01-3750	743-4342-NN-1616		
425	(i) 4X4 / SE / GT	Erillisjousitus	2011-2012		742-5000-01-0366	743-4242-NN-1616		
450	4X4 H1 EFI / LTD	Erillisjousitus	2010-2012		742-5000-01-5600	743-4242-NN-1616		
450	TRV / GT (i)	Erillisjousitus	2011-2012		742-5000-01-4400	743-4242-NN-1616		
450	CORE	Erillisjousitus	-2013		742-5000-01-0366	743-4242-NN-1616		
450		Erillisjousitus	-2014		742-5000-41-0001	743-4242-NN-1616		
454	Manual shift	Jäykkäperä.	1996-1998		742-5000-01-0400	743-4342-NN-1616		
500	(i) 4X4	Erillisjousitus	2002-2003		742-5000-01-0401	743-4242-NN-1616		
500	Automatic 4X4 TBX	Erillisjousitus	2004-2006	HW	742-5000-01-4410	743-4212-NN-1616		
500	TRV automatic 4X4	Erillisjousitus	2004-2006		742-5000-01-4400	743-4242-NN-1616		
500	(i) 4X4 / LE	Erillisjousitus	2005-2009		742-5000-01-5600	743-4242-NN-1616		
500	CORE	Erillisjousitus	2013-2014		742-5000-01-5600	743-4242-NN-1616		
500	TRV CORE	Erillisjousitus	2013-2014		742-5000-01-4400	743-4242-NN-1616		
500	XT	Erillisjousitus	2013-2014		742-5000-01-5600	743-4242-NN-1616		
500	Automatic TBX	Erillisjousitus	-2003	HW	742-5000-01-0410	743-4212-NN-1616		
500	TRV automatic	Erillisjousitus	-2003		742-5000-01-0401	743-4242-NN-1616		
500	(i) 4X4	Erillisjousitus	-2004		742-5000-01-4400	743-4242-NN-1616		
500	TRV Automatic / Plus	Erillisjousitus	-2008		742-5000-01-5710	743-4242-NN-1616		
500	Prowler HDX / XT / Limited	Erillisjousitus	-2014			742-5000-01-1000	743-B242-NN-1616	
500	Manual shift	Jäykkäperä.	1998-2000		742-5000-01-0400	743-4342-NN-1616		
500	Automatic ACT	Jäykkäperä.	2000-2001		742-5000-01-0500	743-4342-NN-1616		
500	Manual shift	Jäykkäperä.	-2001		742-5000-01-1501	743-4342-NN-1616		
500	Automatic	Jäykkäperä.	-2002		742-5000-01-2500	743-4342-NN-1616		
500	Manual shift	Jäykkäperä.	-2002		742-5000-01-3750	743-4342-NN-1616		
500	TBX Cargo	Jäykkäperä.	-2002	HW	742-5000-01-0610	743-4312-NN-1616		
550	(i) H1 EFI / S / LTD / GT / XT	Erillisjousitus	2009-2014		742-5000-01-5600	743-4242-NN-1616		
550	(i) Prowler XT / H1 / EFI	Erillisjousitus	2009-2014			742-5000-01-5510	743-B242-NN-1616	
550	TRV H1 / GT / EFI / Cruiser / XT / LTD	Erillisjousitus	2010-2014		742-5000-01-4400	743-4242-NN-1616		
550	TRV H1 EFI / LE	Erillisjousitus	-2009		742-5000-01-5710	743-4242-NN-1616		
550	CORE	Erillisjousitus	-2013		742-5000-01-5600	743-4242-NN-1616		
650	Prowler XT H1	Erillisjousitus	2006-2009			742-5000-01-6510	743-B242-NN-1818	
650	H1 4X4 Automatic	Erillisjousitus	2006-2010		742-5000-01-4400	743-4242-NN-1616		
650	TRV H1 / Plus	Erillisjousitus	2007-2009		742-5000-01-5710	743-4242-NN-1717		
650	Mud Pro EFI 4x4 H1	Erillisjousitus	2010-2011		742-5000-01-0650	743-4242-NN-1717		
650	H1 4X4 Automatic	Erillisjousitus	2011-2012		742-5000-01-0650	743-4242-NN-1717		
650	(i) 4X4 Automatic	Erillisjousitus	-2004		742-5000-01-5600	743-4242-NN-1616		
650	(i) 4X4	Erillisjousitus	-2005		742-5000-01-5600	743-4242-NN-1616		
650	TBX	Erillisjousitus	-2007	HW	742-5000-01-5610	743-4212-NN-1616		
650	TBX	Erillisjousitus	-2009	HW	742-5000-01-5610	743-4212-NN-1616		
650	(i) 4X4	Erillisjousitus	-2012		742-5000-01-0650	743-4242-NN-1717		
700	(i) H1 EFI / S / SE / LTD / GT / XT	Erillisjousitus	2006-2014		742-5000-01-0700	743-4242-NN-1818		
700	4X4 Diesel	Erillisjousitus	2007-2008		742-5000-01-0700	743-4242-NN-1818		
700	(i) Prowler XT / XTX H1 EFI / LE	Erillisjousitus	2008-2014			742-5000-01-6510	743-B242-NN-1818	
700	TRV H1 EFI / Cruiser / LE / XT / GT / LTD	Erillisjousitus	2008-2014		742-5000-01-5710	743-4242-NN-1818		
700	(i) H1 EFI Mud Pro / LTD	Erillisjousitus	2009-2014		742-5000-01-0700	743-4242-NN-1818		
700	(i) EFI 4x4 H1 TBX / LTD / GT / XT	Erillisjousitus	2010-2013	HW	742-5000-01-5710	743-4212-NN-1717		
700	Super duty / TBX / diesel	Erillisjousitus	2010-2014	HW	742-5000-01-5710	743-4212-NN-1717		
700	(i) Prowler HDX / LTD	Erillisjousitus	2011-2014	A		742-5000-01-1000	743-B242-NN-1818	
700	CORE	Erillisjousitus	-2013		742-5000-01-0700	743-4242-NN-1818		
700	Wildcat Trail / XT	Erillisjousitus	-2014			742-5000-01-1230	743-B242-NN-1818	
1000	Thundercat EFI H2 Automatic / SE / LE	Erillisjousitus	2008-2011		742-5000-01-0700	743-4242-NN-1818		
1000	(i) Prowler XTX H2 EFI / BAJA /	Erillisjousitus	2009-2014	A		742-5000-01-1000	743-B242-NN-1818	
1000	TRV H2 EFI Cruiser / GT / LTD	Erillisjousitus	2009-2014		742-5000-01-5710	743-4242-NN-1818		
1000	(i) Mud Pro EFI 4x4 H2 / LTD	Erillisjousitus	2010-2014		742-5000-01-0700	743-4242-NN-1818		
1000	(i) LTD / GT / XT	Erillisjousitus	2011-2014		742-5000-01-0700	743-4242-NN-1818		
1000	Wildcat / H.O / X / Limited	Erillisjousitus	2012-2014	A	742-5000-01-3250	6722-01-3250	743-B242-NN-1818	
1000	Wildcat 4 / 4X / Limited	Erillisjousitus	2013-2014	A	742-5000-01-3250	6722-01-3250	743-B242-NN-1818	





SOPIVUDET JATKUU

HUOM! Muista tilata kiinnityssarja ja telarunko erikseen (ennen samalla tuotenumeraalla)

				Tatou T4S ATV Telasarjat		Tatou T4S UTV Telasarjat	
CC	BOB CAT	Takajousitus	Vuosimalli	Kiinnityssarja Tuotenr	Telarunkojen Tuotenr	Kiinnityssarja Tuotenr	Telarunkojen Tuotenr
500	3400 4x4 Gas / XL	Erillisjousitus	2011-2014			742-5000-05-0155	743-B242-SS-1615
904	3400 4x4 Diesel / XL	Erillisjousitus	2011-2014			742-5000-05-0155	743-B242-SS-1615
904	3450 4x4 Diesel / RapidLink	Erillisjousitus	2011-2014	F		742-5000-05-0155	743-B242-SS-1615
904	3600 4x4 Diesel	Erillisjousitus	-2014	F		742-5000-05-1083	743-B242-SS-1716
904	3650 4x4 Diesel	Erillisjousitus	-2014	F		742-5000-05-1083	743-B242-SS-1716
-	2200	Jäykkäperä.	2006-2007			742-5000-21-2200-UTV4S	743-B342-NN-1816
-	2200S Crew	Jäykkäperä.	2007-2009			742-5000-21-2200-UTV4S	743-B342-NN-1816
				Tatou T4S ATV Telasarjat		Tatou T4S UTV Telasarjat	
CC	BRP	Takajousitus	Vuosimalli	Kiinnityssarja Tuotenr	Telarunkojen Tuotenr	Kiinnityssarja Tuotenr	Telarunkojen Tuotenr
330	Outlander	Jäykkäperä.	2003-2005	742-5000-02-0400	743-4342-NN-1616		
400	Outlander	Jäykkäperä.	2003-2005	742-5000-02-0400	743-4342-NN-1616		
400	Outlander MAX	Jäykkäperä.	2004-2005	742-5000-02-0401	743-4342-NN-1616		
400	Outlander / XT	Jäykkäperä.	2006-2015	742-5000-02-0406	743-4342-NN-1616		
400	Outlander MAX / XT	Jäykkäperä.	2006-2015	742-5000-02-0426	743-4342-NN-1616		
500	Traxter / XT	Jäykkäperä.	1999-2005	742-5000-02-0651	743-4342-NN-1617		
500	Traxter XL	Jäykkäperä.	2001-2005	742-5000-02-0510	743-4312-NN-1617		
500	Quest / XT	Jäykkäperä.	2002-2004	742-5000-02-0650	743-4342-NN-1717		
500	Traxter MAX	Jäykkäperä.	2003-2005	742-5000-02-0500	743-4342-NN-1617		
500	Outlander / XT	Jäykkäperä.	2007-2012	742-5000-02-0506	743-4342-NN-1717		
500	Outlander MAX / XT	Jäykkäperä.	2007-2012	742-5000-02-0526	743-4342-NN-1717		
500	Renegade	Jäykkäperä.	2008-2012	742-5000-02-0502	743-4342-NN-1717		
500	Outlander / XT / DPS	Jäykkäperä.	2013-2015	742-5000-02-0880	743-4342-NN-1717		
500	Outlander MAX / XT / DPS	Jäykkäperä.	2013-2015	742-5000-02-0880	743-4342-NN-1717		
500	Renegade	Jäykkäperä.	2013-2015	742-5000-02-0880	743-4342-NN-1717		
650	Quest / XT	Jäykkäperä.	2002-2005	742-5000-02-0650	743-4342-NN-1717		
650	Outlander / XT / XT-P	Jäykkäperä.	2006-2012	742-5000-02-0606	743-4342-NN-1818		
650	Outlander MAX / XT / XT-P	Jäykkäperä.	2006-2012	742-5000-02-0626	743-4342-NN-1818		
650	Outlander / XT / DPS / X mr	Jäykkäperä.	2013-2015	742-5000-02-0880	743-4342-NN-1818		
650	Outlander MAX / XT / DPS	Jäykkäperä.	2013-2015	742-5000-02-0880	743-4342-NN-1818		
650	Quest MAX / XT	Jäykkäperä.	-2005	742-5000-02-0655	743-4342-NN-1717		
650	Traxter / XT	Jäykkäperä.	-2005	742-5000-02-0650	743-4342-NN-1717		
650	Traxter MAX / XT	Jäykkäperä.	-2005	742-5000-02-0655	743-4342-NN-1717		
800	Outlander XT / XT-P	Jäykkäperä.	2006-2011	742-5000-02-0800	743-4342-NN-1818		
800	Outlander MAX / X mr / XT / XT-P / LTD	Jäykkäperä.	2006-2012	742-5000-02-0801	743-4342-NN-1818		
800	Renegade / X XC	Jäykkäperä.	2007-2011	742-5000-02-0802	743-4342-NN-1818		
800	Commander XT / R / DPS	Jäykkäperä.	2011-2015	A		742-5000-02-1000	743-B342-NN-1818
800	Renegade / R / X XC	Jäykkäperä.	2012-2015	742-5000-02-0880	743-4342-NN-1818		
800	Outlander / R / XT / XT-P / X mr / DPS	Jäykkäperä.	2013-2015	742-5000-02-0880	743-4342-NN-1818		
800	Outlander MAX / R / DPS / XT / XT-P	Jäykkäperä.	2013-2015	742-5000-02-0880	743-4342-NN-1818		
800	Outlander X XC	Jäykkäperä.	-2011	742-5000-02-0802	743-4342-NN-1818		
800	Outlander XT / R	Jäykkäperä.	-2012	742-5000-02-0880	743-4342-NN-1818		
1000	Maverick / X rs / DPS / X mr	Erillisjousitus	2013-2015	A		742-5000-02-1101	743-B242-NN-1818
1000	Maverick MAX / X rs / DPS (4 seats)	Erillisjousitus	2014-2015	A		742-5000-02-1101	743-B242-NN-1818
1000	Maverick X xc DPS	Erillisjousitus	2014-2015	A		742-5000-02-1509	743-B242-NN-1818
1000	Commander XT / X / LIMITED / DPS / XT-P	Jäykkäperä.	2011-2015	A		742-5000-02-1000	743-B342-NN-1818
1000	Outlander / DPS / XT / XT-P / X mr	Jäykkäperä.	2012-2015		742-5000-02-0880	743-4342-NN-1818	
1000	Renegade / X XC	Jäykkäperä.	2012-2015		742-5000-02-0880	743-4342-NN-1818	
1000	Outlander MAX DPS / XT / XT-P / LIMITED	Jäykkäperä.	2013-2015		742-5000-02-0880	743-4342-NN-1818	
1000	Commander MAX DPS / XT (4 seats)	Jäykkäperä.	2014-2015	A		742-5000-02-1000	743-B342-NN-1818
				Tatou T4S ATV Telasarjat		Tatou T4S UTV Telasarjat	
CC	CF moto	Takajousitus	Vuosimalli	Kiinnityssarja Tuotenr	Telarunkojen Tuotenr	Kiinnityssarja Tuotenr	Telarunkojen Tuotenr
500	Swat / Rancher	Erillisjousitus	2008-2012			742-5000-10-2500	743-B242-NN-1717
500	Trail tracker EX / C Force / Matrix	Erillisjousitus	2011-2014	742-5000-10-0605	743-4242-NN-1616		
500	Yukon	Erillisjousitus	-2006	742-5000-10-0500	743-4242-NN-1616		
500	Moose / Atlas	Erillisjousitus	-2008	742-5000-10-0500	743-4242-NN-1616		
600	Snyper EFI / Z Force / Terracross	Erillisjousitus	2011-2014			742-5000-10-2600	743-B242-NN-1717
600	Trail tracker EX / C Force / Terralander X6	Erillisjousitus	2011-2014	742-5000-10-0605	743-4242-NN-1717		
600	Swat / Rancher	Erillisjousitus	-2013			742-5000-10-2500	743-B242-NN-1616
800	Terra Lander / X8 / C force (Steel rear lower a-arm only)	Erillisjousitus	2012-2014	742-5000-10-0605	743-4242-NN-1717		
800	Terra Lander / X8 / C force (Full aluminium a-arm)	Erillisjousitus	-2013	742-5000-10-0860	743-4242-NN-1717		
800	Snyper EX / Z Force / Terracross	Erillisjousitus	-2014	A		742-5000-10-1715	743-B242-NN-1818
800	Tracker / U Force	Erillisjousitus	-2014	A		742-5000-10-1379	743-B242-NN-1717



Vanteet ja renkaat



Talvituotteet



Vinsit



Laukut ja tuulisuojat



Sähköosat



Jousitus ja voimansiirto



Pakoputket ja suutinsarjat



Ohjaus



Rungon osat ja peitteet



Jarrupalat ja rattaat



Moottori



Variaattorin osat



Maatalous-tarvikkeet



Kärryt ja reet

ATV



SOPIVUUDET JATKUU



HUOM! Muista tilata kiinnityssarja ja telarunko erikseen (ennen samalla tuotenumeroilla)

				Tatou T4S ATV Telasarjat		Tatou T4S UTV Telasarjat	
CC	Honda	Takajousitus	Vuosimalli	Kiinnityssarja Tuotenr	Telarunkojen Tuotenr	Kiinnityssarja Tuotenr	Telarunkojen Tuotenr
300	TRX Fourtrax	Jäykkäperä.	1988-1992	742-5000-03-8300	743-4342-NN-8515		
300	TRX Fourtrax	Jäykkäperä.	1993-2000	742-5000-03-3300	743-4342-NN-8515		
350	TRX Fourtrax	Jäykkäperä.	1986-1993	742-5000-03-6350	743-4342-NN-1616		
350	TRX Rancher	Jäykkäperä.	1994-2006	742-5000-03-4350	743-4342-NN-1515		
400	TRX Foreman	Jäykkäperä.	1995-2003	742-5000-03-6400	743-4342-NN-1616		
400	TRX Foreman / Rancher	Jäykkäperä.	2004-2007	742-5000-03-4350	743-4342-NN-1515		
420	TRX Foreman / Rancher (Rear Independent Suspension)	Erillisjousitus	2009-2014	742-5000-03-0429	743-4242-NN-1616		
420	TRX Foreman / Rancher (Rear Rigid Axle)	Jäykkäperä.	2007-2013	742-5000-03-0420	743-4342-NN-1616		
420	TRX Foreman / Rancher (Rear Rigid Axle)	Jäykkäperä.	-2014	742-5000-03-0337	743-4342-NN-1616		
450	TRX Foreman	Jäykkäperä.	1998-2004	742-5000-03-0450	743-4342-NN-1616		
500	TRX Rubicon	Jäykkäperä.	2001-2004	742-5000-03-0500	743-4342-NN-1616		
500	TRX Foreman	Jäykkäperä.	2005-2011	742-5000-03-5500	743-4342-NN-1616		
500	TRX Rubicon / EPS	Jäykkäperä.	2005-2014	742-5000-03-5500	743-4342-NN-1616		
500	TRX Foreman	Jäykkäperä.	2012-2013	742-5000-03-0512	743-4342-NN-1616		
500	TRX Foreman	Jäykkäperä.	-2014	742-5000-03-0244	743-4342-NN-1616		
650	TRX Rincon	Erillisjousitus	2003-2005	742-5000-03-0650	743-4242-NN-1616		
680	TRX Rincon	Erillisjousitus	2006-2014	742-5000-03-0650	743-4242-NN-1616		
680	Big Red	Erillisjousitus	2009-2011			742-5000-03-2680	743-B242-NN-1616
700	Big Red	Erillisjousitus	2012-2013			742-5000-03-2680	743-B242-NN-1616
700	Pioneer / 4 (4 seats)	Erillisjousitus	-2014			742-5000-03-1278	743-B242-NN-1616
CC	John Deere	Takajousitus	Vuosimalli	Kiinnityssarja Tuotenr	Telarunkojen Tuotenr	Kiinnityssarja Tuotenr	Telarunkojen Tuotenr
500	Buck	Jäykkäperä.	2005-2006	742-5000-02-0650	743-4342-NN-1717		
500	Buck EXT	Jäykkäperä.	2005-2006	742-5000-02-0510	743-4312-NN-1617		
500	Trail Buck	Jäykkäperä.	2005-2006	742-5000-02-0650	743-4342-NN-1717		
550	Gator XUV 4X4 / S4	Erillisjousitus	2012-2014			742-5000-20-5550	743-B242-NN-1616
617	Gator HPX 4X4 High Performance Series	Jäykkäperä.	2004-2014			742-5000-20-0610-UTV4S	743-B342-QQ-1716
620	(i) Gator XUV 4X4 Gas	Erillisjousitus	2007-2009			742-5000-20-0620	743-B242-QQ-1716
625	(i) Gator XUV 4X4	Erillisjousitus	2010-2014			742-5000-20-0625	743-B242-QQ-1716
650	(i) Gator XUV 4X4	Erillisjousitus	2007-2008			742-5000-20-0620	743-B242-QQ-1716
650	Buck	Jäykkäperä.	2005-2006	742-5000-02-0650	743-4342-NN-1717		
650	Trail Buck	Jäykkäperä.	2005-2006	742-5000-02-0650	743-4342-NN-1717		
650	Buck EXT	Jäykkäperä.	-2005	742-5000-20-0650	743-4312-NN-1617		
825	(i) Gator XUV 4X4 / Power steering / S4	Erillisjousitus	2010-2014			742-5000-20-0625	743-B242-QQ-1817
850	(i) Gator RSX / Sport / Trail	Erillisjousitus	2012-2014			742-5000-20-1788	743-B242-NN-1818
854	Gator HPX 4X4 Diesel	Jäykkäperä.	2004-2014			742-5000-20-0610-UTV4S	743-B342-QQ-1716
850D	Gator XUV 4X4	Erillisjousitus	2007-2009			742-5000-20-0620	743-B242-QQ-1716
855D	Gator XUV 4X4 / Power steering / S4	Erillisjousitus	2010-2014			742-5000-20-0625	743-B242-QQ-1716
				Tatou T4S ATV Telasarjat		Tatou T4S UTV Telasarjat	
CC	Kawasaki	Takajousitus	Vuosimalli	Kiinnityssarja Tuotenr	Telarunkojen Tuotenr	Kiinnityssarja Tuotenr	Telarunkojen Tuotenr
300	KLF Bayou 4X4	Jäykkäperä.	1989-2005	742-5000-04-0300	743-4342-NN-1515		
300	KVF Prairie 4X4	Jäykkäperä.	1999-2000	742-5000-04-7300	743-4342-NN-1515		
300	KVF Prairie 4X4	Jäykkäperä.	2001-2002	742-5000-04-1300	743-4342-NN-1515		
360	KVF Prairie	Jäykkäperä.	2003-2005	742-5000-04-0360	743-4342-NN-1515		
360	KVF Prairie	Jäykkäperä.	2006-2012	742-5000-04-0366	743-4342-NN-1515		
400	KLF Bayou	Jäykkäperä.	1993-1999	742-5000-04-0400	743-4342-NN-1616		
400	KVF Prairie	Jäykkäperä.	1997-1998	742-5000-04-7400	743-4342-NN-1515		
400	KVF Prairie	Jäykkäperä.	1999-2000	742-5000-04-9400	743-4342-NN-1515		
400	KVF Prairie	Jäykkäperä.	2001-2002	742-5000-04-1400	743-4342-NN-1515		
400	KAF A Mule 610 / XC / SE	Jäykkäperä.	2006-2014			742-5000-04-0610-UTV4S	743-B342-NN-1515
620	KAF E / J / H Mule 3010	Jäykkäperä.	2001-2008			742-5000-04-3010-UTV4S	743-B342-NN-1516
620	KAF / Mule 3010 4x4 TRANS	Jäykkäperä.	2005-2008			742-5000-04-3010-UTV4S	743-B342-NN-1516
620	KAF / Mule 4010 4x4 TRANS	Jäykkäperä.	2009-2014			742-5000-04-3010-UTV4S	743-B342-NN-1516
620	KAF M / R Mule 4010	Jäykkäperä.	2009-2014			742-5000-04-3010-UTV4S	743-B342-NN-1516
650	(i) KVF G / H / F Brute Force	Erillisjousitus	2006-2014	742-5000-04-0750	743-4242-NN-1717		
650	KVF A / D / E Brute Force (Rear Rigid Axle)	Jäykkäperä.	2002-2014	742-5000-04-0650	743-4342-NN-1616		
700	KVF A / B / D (Rear Rigid Axle)	Jäykkäperä.	2004-2007	742-5000-04-0650	743-4342-NN-1616		
750	(i) KVF A / B / C / D / E / F / EPS / SE / Brute Force	Erillisjousitus	2005-2014	742-5000-04-0750	743-4242-NN-1717		
750	(i) Teryx 4X4 / LE / SPORT	Erillisjousitus	2008-2013			742-5000-04-0080	743-B242-NN-1818
750	(i) Teryx 4X4 / EPS / LE (Crew)	Erillisjousitus	2012-2013			742-5000-04-0484	743-B242-NN-1818
800	Teryx 4 FI 4x4 / EPS / LE / CAMO	Erillisjousitus	-2014			742-5000-04-0484	743-B242-NN-1818
800	Teryx FI 4x4 / EPS / LE	Erillisjousitus	-2014			742-5000-04-0484	743-B242-NN-1818
953	KAF E / J / H Mule 3010	Jäykkäperä.	2001-2008			742-5000-04-3010-UTV4S	743-B342-NN-1516
953	KAF / Mule 3010 4x4 TRANS	Jäykkäperä.	2007-2008			742-5000-04-3010-UTV4S	743-B342-NN-1516
953	KAF / Mule 4010 4x4 TRANS / SE	Jäykkäperä.	2009-2014			742-5000-04-3010-UTV4S	743-B342-NN-1516
953	KAF M / R Mule 4010	Jäykkäperä.	2009-2014			742-5000-04-3010-UTV4S	743-B342-NN-1516



Vanteet ja renkaat



Talvituetteet



Vinssit



Laukut ja tuulisuojat



Sähköosat



Jousitus ja voimansiirto



Pakoputket ja suutinsarjat



Ohjaus



Rungon osat ja peitteet



Jarrupalat ja rattaat



Moottori



Variaattorin osat



Maatalous-tarvikkeet



Kärryt ja reet

ATV



HUOM! Muista tilata kiinnityssarja ja telarunko erikseen (ennen samalla tuotenumeroilla)

				Tatou T4S ATV Telasarjat		Tatou T4S UTV Telasarjat	
CC	Kiotti	Takajousitus	Vuosimalli	Kiinnityssarja Tuotenr	Telarunkojen Tuotenr	Kiinnityssarja Tuotenr	Telarunkojen Tuotenr
1000	MECHRON 2200	Erillisjousitus	2011-2012			742-5000-32-2100	743-B242-NN-1616
				Tatou T4S ATV Telasarjat		Tatou T4S UTV Telasarjat	
CC	Kubota	Takajousitus	Vuosimalli	Kiinnityssarja Tuotenr	Telarunkojen Tuotenr	Kiinnityssarja Tuotenr	Telarunkojen Tuotenr
400	RTV CI	Erillisjousitus	-2013			742-5000-08-0500	743-B242-NN-1515
500	RTV / R	Erillisjousitus	2009-2014	D		742-5000-08-0500	743-B242-NN-1515
900	RTV-X Diesel	Erillisjousitus	-2014			742-5000-08-2280	743-B242-NN-1717
900	RTV R / G / W / T / XT	Jäykkäperä.	2005-2014			742-5000-08-0910-UTV4S	743-B342-QQ-1616
1100	RTV-X C Diesel	Erillisjousitus	-2014			742-5000-08-2280	743-B242-NN-1717
1100	RTV T / H / A	Jäykkäperä.	2008-2014	C		742-5000-08-1100-UTV4S	743-B342-QQ-1616
1120	RTV-X D Diesel	Erillisjousitus	-2014			742-5000-08-2280	743-B242-NN-1717
1140	RTV / CPX	Jäykkäperä.	2010-2014			742-5000-08-1100-UTV4S	743-B342-QQ-1616
				Tatou T4S ATV Telasarjat		Tatou T4S UTV Telasarjat	
Kymco				Kiinnityssarja Tuotenr	Telarunkojen Tuotenr	Kiinnityssarja Tuotenr	Telarunkojen Tuotenr
375	MXU IRS	Erillisjousitus	2009-2010	742-5000-01-0366	743-4242-NN-1616		
500	MXU i IRS / LE	Erillisjousitus	2009-2014	742-5000-41-0001	743-4242-NN-1616		
500	UXV i / LE / HE / SP / TURF	Erillisjousitus	2009-2014			742-5000-41-1500	743-B242-NN-1717
500	MXU	Jäykkäperä.	2007-2011	742-5000-41-0500	743-4342-NN-1616		
700	MXU i / LE	Erillisjousitus	-2013	742-5000-41-0001	743-4242-NN-1717		
700	UXV i / LE / HE / SP / TURF	Erillisjousitus	-2014			742-5000-41-1500	743-B242-NN-1717
				Tatou T4S ATV Telasarjat		Tatou T4S UTV Telasarjat	
CC	New Holland	Takajousitus	Vuosimalli	Kiinnityssarja Tuotenr	Telarunkojen Tuotenr	Kiinnityssarja Tuotenr	Telarunkojen Tuotenr
675	Rustler 125 UV Gas (2 passengers)	Jäykkäperä.	-2012			742-5000-21-2200-UTV4S	743-B342-NN-1816
675	Rustler 125 UV Gas (4 passengers)	Jäykkäperä.	-2012			742-5000-21-2200-UTV4S	743-B342-NN-1816
917	Rustler 120 UV Diesel (2 passengers)	Jäykkäperä.	-2012			742-5000-21-2200-UTV4S	743-B342-NN-1816
917	Rustler 120 UV Diesel (4 passengers)	Jäykkäperä.	-2012			742-5000-21-2200-UTV4S	743-B342-NN-1816
				Tatou T4S ATV Telasarjat		Tatou T4S UTV Telasarjat	
CC	Polaris	Takajousitus	Vuosimalli	Kiinnityssarja Tuotenr	Telarunkojen Tuotenr	Kiinnityssarja Tuotenr	Telarunkojen Tuotenr
325	4X4 Magnum (Front Big Hub)	Erillisjousitus	2000-2002				
325	Xpedition (Front Big Hub)	Erillisjousitus	2000-2002				
325	Sportsman ACE (32 HP)	Erillisjousitus	2014-2015	742-5000-05-0327	743-4242-SS-1615		
330	4X4 Magnum (Front small hub)	Jäykkäperä.	2003-2006	742-5000-05-2500	743-4342-PP-1615		
330	ATP	Jäykkäperä.	2004-2005	742-5000-05-0014-UTV4S	743-4312-PP-1716		
400	Sportsman H.O. (Except model without *LOW*)	Erillisjousitus	2005-2014	742-5000-05-4550	743-4242-SS-1615		
400	Ranger 4X4 EFI	Erillisjousitus	2010-2014			742-5000-05-4000	743-B242-SS-1615
400	Sportsman	Erillisjousitus	-2004,5	742-5000-05-4500	743-4242-SS-1615		
450	Sportsman	Erillisjousitus	2006-2007	742-5000-05-4551	743-4242-SS-1716		
500	Sportsman H.O.	Erillisjousitus	2005-2007	742-5000-05-4551	743-4242-SS-1716		
500	Ranger 4X4	Erillisjousitus	2005-2008			742-5000-05-0525	743-B242-SS-1716
500	Sportsman X2	Erillisjousitus	2006-2007	742-5000-05-1020	743-4242-SS-1716		
500	Sportsman X2	Erillisjousitus	2008-2009	742-5000-05-0029	743-4242-SS-1716		
500	Sportsman EFI Touring HO	Erillisjousitus	2008-2013	742-5000-05-0029	743-4242-SS-1716		
500	Sportsman H.O.	Erillisjousitus	2008-2013	742-5000-05-4551	743-4242-SS-1716		
500	Ranger 4X4 / EFI	Erillisjousitus	2010-2013	742-5000-05-0511		6722-05-0511	743-B242-SS-1716
500	Ranger Crew 4X4 EFI	Erillisjousitus	2011-2013	742-5000-05-4000		6722-05-4000	743-B242-SS-1615
500	Sportsman (Front small hub)	Erillisjousitus	-2004,5	742-5000-05-4501	743-4242-SS-1716		
500	Ranger 4X4 / EFI	Erillisjousitus	-2009			742-5000-05-0509	743-B242-SS-1716
500	Magnum RMK	Jäykkäperä.	1999-2001	742-5000-05-0501	743-4322-PK-1615		
500	Ranger 6X6	Jäykkäperä.	2000-2007			742-5000-05-0026-UTV4S	743-B342-SS-1615
500	Ranger 4X4	Jäykkäperä.	2002-2004			742-5000-05-0015-UTV4S	743-B342-SS-1716
500	ATP H.O.	Jäykkäperä.	2004-2005	742-5000-05-0014-UTV4S	743-4312-PP-1716		
500	Magnum RMK	Jäykkäperä.	-2002	742-5000-05-2501	743-4342-PP-1716		
550	Sportsman / XP / EPS	Erillisjousitus	2009-2014	742-5000-05-0550	743-4242-SS-1716		
550	Sportsman Touring / EPS	Erillisjousitus	2010-2014	742-5000-05-0550	743-4242-SS-1716		
550	Sportsman X2 / EPS	Erillisjousitus	2010-2014	742-5000-05-0550	743-4242-SS-1716		
570	Sportsman X2 EPS	Erillisjousitus	-2015	742-5000-05-0045	743-4242-SS-1716		
570	RZR / Trail / EPS	Erillisjousitus	2012-2015			742-5000-05-0570	743-B242-SS-1716
570	Ranger Crew EFI / EPS	Erillisjousitus	-2014			742-5000-05-0295	743-B242-SS-1716
570	Ranger EFI / EPS	Erillisjousitus	-2014			742-5000-05-0295	743-B242-SS-1716
570	Sportsman EFI / EPS	Erillisjousitus	2014-2015	742-5000-05-4551	743-4242-SS-1716		
570	Sportsman Touring EPS	Erillisjousitus	2014-2015	742-5000-05-4551	743-4242-SS-1716		
600	Sportsman Twin	Erillisjousitus	2003-2004,5	742-5000-05-4501	743-4242-SS-1716		
600	Sportsman Twin	Erillisjousitus	2005-2007	742-5000-05-4551	743-4242-SS-1716		
700	Sportsman Twin	Erillisjousitus	2002-2004,5	742-5000-05-4501	743-4242-SS-1716		
700	Sportsman MV7	Erillisjousitus	2005-2006	742-5000-05-0710	743-4212-SS-1716		
700	Sportsman Twin	Erillisjousitus	2005-2007	742-5000-05-4551	743-4242-SS-1716		
700	Ranger 4X4	Erillisjousitus	2005-2008			742-5000-05-0515	743-B242-SS-1817
700	Ranger Crew 4X4	Erillisjousitus	2008-2009			742-5000-05-0525	743-B242-SS-1716
700	Sportsman X2	Erillisjousitus	-2008	742-5000-05-0029	743-4242-SS-1716		
700	Ranger HD / XP	Erillisjousitus	-2009			742-5000-05-0519	743-B242-SS-1817
700	Ranger 4X4	Jäykkäperä.	2002-2004			742-5000-05-0015-UTV4S	743-B342-SS-1716



Vanteet ja renkaat



Talvutuotteet



Vinsit



Laukut ja tuulisuojat



Sähköosat



Jousitus ja voimansiirto



Pakoputket ja suutinsarjat



Ohjaus



Rungon osat ja peitteet



Jarrupalat ja rattaat



Moottori



Variaattorin osat



Maatalous-tarvikkeet



Kärryt ja reet

ATV





HUOM! Muista tilata kiinnityssarja ja telarunko erikseen (ennen samalla tuotenumeroilla)

CC	Polaris	Takajousitus	Vuosimalli	Tatou T4S ATV Telasarjat		Tatou T4S UTV Telasarjat	
				Kiinnityssarja Tuotenr	Telarunkojen Tuotenr	Kiinnityssarja Tuotenr	Telarunkojen Tuotenr
700	Ranger 6X6 EFI	Jäykkäperä.	2005-2009			742-5000-05-0726-UTV4S	743-B342-SS-1817
800	Sportsman Twin EFI	Erillisjousitus	2005-2007	742-5000-05-0800	743-4242-SS-1817		
800	Sportsman X2	Erillisjousitus	2006-2007	742-5000-05-1028	743-4242-SS-1817		
800	Sportsman Touring	Erillisjousitus	2008-2009	742-5000-05-0030	743-4242-SS-1817		
800	Sportsman X2	Erillisjousitus	2008-2009	742-5000-05-0030	743-4242-SS-1817		
800	Razor RZR / EPS / XC	Erillisjousitus	2008-2014	A, B		742-5000-05-0028	743-B242-SS-1817
800	Sportsman EFI	Erillisjousitus	2008-2014		742-5000-05-0800	743-4242-SS-1817	
800	Razor RZR S / HO / EPS	Erillisjousitus	2009-2014	A		742-5000-05-0025	743-B242-SS-1817
800	Sportsman 6X6 / Big Boss / Magnum	Erillisjousitus	2009-2014			742-5000-05-6006	743-B242-SS-1817
800	Ranger 6X6 EFI	Erillisjousitus	2010-2014			742-5000-05-1600	743-B242-SS-1817
800	Ranger Crew / EFI / EPS	Erillisjousitus	2010-2014			742-5000-05-0519	743-B242-SS-1817
800	Ranger EFI / HD / XP / XP EPS	Erillisjousitus	2010-2014			742-5000-05-0519	743-B242-SS-1817
800	Razor RZR 4	Erillisjousitus	2010-2014	A		742-5000-05-0025	743-B242-SS-1817
800	Ranger EFI Midsize / EPS	Erillisjousitus	2013-2014			742-5000-05-0515	743-B242-SS-1817
850	Sportsman XP / HO / EPS	Erillisjousitus	2009-2014		742-5000-05-5585	743-4242-SS-1817	
850	Sportsman Touring HO EPS	Erillisjousitus	2010-2014		742-5000-05-5585	743-4242-SS-1817	
850	Sportsman X2	Erillisjousitus	2011-2012		742-5000-05-5585	743-4242-SS-1817	
850	Scrambler XP HO / EPS	Erillisjousitus	2013-2014		742-5000-05-5585	743-4242-SS-1817	
850	Sportsman WV850 HO	Erillisjousitus	-2014		742-5000-05-0075	743-4242-SS-1817	
900	RZR XP / EPS / Jagged X	Erillisjousitus	2011-2014	A		742-5000-05-0900	743-B242-SS-1817
900	RZR XP 4	Erillisjousitus	2012-2014	A		742-5000-05-0900	743-B242-SS-1817
900	Ranger XP / EPS / Deluxe / Hunter / Northstar	Erillisjousitus	2013-2015	A		742-5000-05-0399	743-B242-SS-1817
900	Ranger Crew XP / EPS	Erillisjousitus	2014-2015	A		742-5000-05-0399	743-B242-SS-1817
904	Ranger 4x4 Diesel	Erillisjousitus	2011-2014			742-5000-05-0509	743-B242-SS-1716
904	Ranger Crew 4X4 Diesel	Erillisjousitus	2011-2014			742-5000-05-0509	743-B242-SS-1716
904	Brutus / HD / PTO	Erillisjousitus	-2013	F		742-5000-05-1083	743-B242-SS-1716
904	Ranger Diesel HST	Erillisjousitus	-2014	F		742-5000-05-1083	743-B242-SS-1716
1000	Scrambler XP EPS	Erillisjousitus	-2014		742-5000-05-0075	743-4242-SS-1817	
1000	RZR XP 4 EPS	Erillisjousitus	-2014	A		742-5000-05-1114	743-B242-SS-1817
1000	RZR XP EPS	Erillisjousitus	-2014	A		742-5000-05-1114	743-B242-SS-1817

CC	Suzuki	Takajousitus	Vuosimalli	Tatou T4S ATV Telasarjat		Tatou T4S UTV Telasarjat	
				Kiinnityssarja Tuotenr	Telarunkojen Tuotenr	Kiinnityssarja Tuotenr	Telarunkojen Tuotenr
300	King Quad	Erillisjousitus	1992-2004	742-5000-06-0300	743-4242-ON-1516		
400	LTF Eiger	Jäykkäperä.	2002-2007	742-5000-06-0400	743-4342-NN-1616		
400	LTA / LTF King Quad / ASi / FSi	Jäykkäperä.	2008-2014	B	742-5000-06-0400	743-4342-NN-1616	
450	LTA King Quad	Erillisjousitus	2008-2009		742-5000-06-0458	743-4242-NN-1616	
450	LTA King Quad	Erillisjousitus	-2007		742-5000-06-0450	743-4242-NN-1616	
500	King Quad AXi power steering / XP	Erillisjousitus	2009-2014	B, C	742-5000-06-0460	743-4242-NN-1616	
500	King Quad AXi / XC	Erillisjousitus	2011-2014	B, C	742-5000-06-0458	743-4242-NN-1616	
500	QuadRunner Manual shift	Jäykkäperä.	1998-2002		742-5000-06-0501	743-4342-ON-1616	
500	QuadMaster Automatic	Jäykkäperä.	2000-2001		742-5000-06-0500	743-4342-ON-1616	
500	Vinson Series	Jäykkäperä.	2002-2007	B	742-5000-06-2500	743-4342-NN-1616	
700	LTA King Quad	Erillisjousitus	2005-2007	B	742-5000-06-0700	743-4242-NN-1818	
700	Twin Peaks	Jäykkäperä.	-2004		742-5000-04-0650	743-4342-NN-1616	
750	LTA King Quad	Erillisjousitus	2008-2009	B	742-5000-06-0758	743-4242-NN-1818	
750	King Quad AXi power steering / Limited edition / XP	Erillisjousitus	2009-2014	B	742-5000-06-0760	743-4242-NN-1818	
750	King Quad / AXi / XC / X / Limited edition	Erillisjousitus	2011-2014	B	742-5000-06-0758	743-4242-NN-1818	

CC	Yamaha	Takajousitus	Vuosimalli	Tatou T4S ATV Telasarjat		Tatou T4S UTV Telasarjat	
				Kiinnityssarja Tuotenr	Telarunkojen Tuotenr	Kiinnityssarja Tuotenr	Telarunkojen Tuotenr
350	(i) Grizzly / Kodiak	Erillisjousitus	2007-2011	742-5000-07-0451	743-4242-NN-1515		
350	Big Bear Dual range (Rear disk brake)	Jäykkäperä.	1987-2000	742-5000-07-8350	743-4342-NN-1616		
350	Big Bear Dual range (Rear drum brake)	Jäykkäperä.	1987-2000	742-5000-07-7350	743-4342-NN-1616		
350	Wolverine 4X4	Jäykkäperä.	1995-2001	742-5000-07-7400	743-4342-NN-1616		
350	Big Bear 5-speed	Jäykkäperä.	1997-1998	742-5000-07-7400	743-4342-NN-1616		
350	Grizzly / Bruin Auto 4X4	Jäykkäperä.	2004-2014	742-5000-07-1400	743-4342-NN-1515		
400	(i) Kodiak Ultramatic	Erillisjousitus	2005-2008	742-5000-07-0451	743-4242-NN-1515		
400	(i) Big Bear 4X4	Erillisjousitus	2007-2012	742-5000-07-0459	743-4242-NN-1515		
400	Kodiak Dual range	Jäykkäperä.	1993-2000	742-5000-07-7350	743-4342-NN-1616		
400	Big Bear 5-speed	Jäykkäperä.	2000-2002	742-5000-07-0400	743-4342-NN-1616		
400	Kodiak Ultramatic	Jäykkäperä.	2000-2002	742-5000-07-2400	743-4342-NN-1515		
400	Big Bear Pro Dual range	Jäykkäperä.	2002-2005	742-5000-07-7350	743-4342-NN-1616		
400	Kodiak & Grizzly Ultramatic	Jäykkäperä.	2003-2004	742-5000-07-1400	743-4342-NN-1515		
400	Kodiak (Rear drum brake)	Jäykkäperä.	-1999	742-5000-07-4400	743-4342-NN-1616		
450	(i) Grizzly & Kodiak 4x4 / Ultramatic / EPS	Erillisjousitus	2005-2014	742-5000-07-0450	743-4242-NN-1616		
450	YXR Rhino 4X4	Erillisjousitus	2006-2009			742-5000-07-5400	743-B242-NN-1616
450	Kodiak & Grizzly Ultramatic	Jäykkäperä.	2003-2004	742-5000-07-1401	743-4342-NN-1616		
450	Wolverine 4X4	Jäykkäperä.	2006-2008	742-5000-07-1401	743-4342-NN-1616		



Vanteet ja renkaat



Talvituotteet



Vinssit



Laukut ja tuulisuojat



Sähköosast



Jousitus ja voimansiirto



Pakoputket ja suutinsarjat



Ohjaus



Rungon osat ja peitteet



Jarrupalat ja rattaat



Moottori



Variaattorin osat



Maatalous-tarvikkeet



Kärryt ja reet



HUOM! Muista tilata kiinnityssarja ja telarunko erikseen (ennen samalla tuotenumeroilla)

CC	Yamaha	Takajousitus	Vuosimalli	Tatou T4S ATV Telasarjat		Tatou T4S UTV Telasarjat	
				Kiinnityssarja Tuotenr	Telarunkojen Tuotenr	Kiinnityssarja Tuotenr	Telarunkojen Tuotenr
550	Grizzly FI Auto 4X4 / EPS / LE / S-LE	Erillisjousitus	2009-2014	742-5000-07-0550	743-4242-NN-1717		
600	Grizzly Auto 4X4	Jäykkäperä.	1999-2001	742-5000-07-9600	743-4342-NN-1717		
600	Grizzly Auto 4X4	Jäykkäperä.	-1998	742-5000-07-8600	743-4342-NN-1717		
660	Grizzly Auto 4X4	Erillisjousitus	2002-2008	742-5000-07-0660	743-4242-NN-1717		
660	YXR Rhino Auto 4X4	Erillisjousitus	2004-2007			742-5000-07-4610	743-B242-NN-1818
700	Grizzly FI Auto 4X4 / EPS	Erillisjousitus	2007-2013	742-5000-07-0700	743-4242-NN-1818		
700	YXR Rhino FI	Erillisjousitus	2008-2013			742-5000-07-4610	743-B242-NN-1717
700	Grizzly FI / EPS / SE / S-LE	Erillisjousitus	-2014	742-5000-07-0997	743-4242-NN-1818		
700	Viking / EPS	Erillisjousitus	-2014			742-5000-07-1425	743-B242-NN-1818

Tekniset tiedot

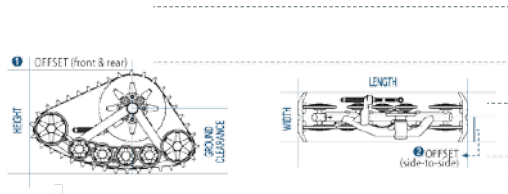

Alusta	CAMOPLAST ATV T4S	CAMOPLAST UTV T4S
Paino	30 kg	Etu: 43 kg Taka: 51 kg
Offset (etu & taka)	Etu: 611 mm Taka: 662 mm Yhteensä: 1 298 mm	Etu: 673 mm Taka: 889 mm Kokonais: 1 562 mm
Offset (rinnanistuttava)	153 mm	178 mm
Pituus	Etu: 1 015 mm Taka: 1 081 mm	Etu: 1 081 mm Taka: 1 321 mm
Korkeus	560 mm	635 mm
Asennusosien paino	Noin 2,75 kg	Noin 2,75 kg
Kumitela		
Leveys	Etu: 292 mm Taka: 318 mm	Etu: 318 mm Taka: 343 mm
Pituus	Etu: 2 377 mm Taka: 2 507 mm	Etu: 2 507 mm Taka: 2 964 mm
Kuvion syvyys	Etu: 25 mm Taka: 30 mm	Etu: 25 mm Taka: 25 mm
Suorituskyky		
Pinta-ala	1,30 m ²	1,59 m ²
Maavara (keskimäärin)	Lisäys 76 mm	Lisäys 127 mm
Säilytetty nopeus (keskimäärin)	65%	65%
Tekniset tiedot		
Vaihteen tyyppi	Sisäinen vaihde	Sisäinen vaihde
Kumitela	Etu: Flex Taka: Suora	Etu: Suora Taka: Suora
Runko	Rakenneteräs	Rakenneteräs
Hammasyövä	15 - 18 hammasta	15 - 18 hammasta
Pyörät	133 & 201 mm suljetut ja tiivistetyt pyörät elastomeeriulkokehällä	132 mm tiivistetyllä kaksoislaakerilla pyörät (leveys: 50 mm) 255 mm tiivistetyllä kaksoislaakerilla, puhkeamaton
Kiertymisenesto	Uudelleensuunn. kiertymisenesto rakenneterästä Jousi ja progressiivinen vaimennin	Uudelleensuunn. kiertymisenesto rakenneterästä Jousi ja progressiivinen vaimennin
Keskiö ja laakeri	Monipulttinen keskiö valuterästä 4-pulttinen kehä	Monipulttinen keskiö valuterästä 4- ja 5-pulttinen kehä
Ohjain	Uudelleensuunniteltu valettu UHMW	Pursotettu UHMW
Tandem ja tuenta	Yksinkertainen tandem edessä nivelpisteessä	Kaksoistandem jokaisessa nivelpisteessä
Huolto		
Asennusaika	Noin 1,5 h	Noin 1,5 h
Seuraavat	Alle 1 h	Alle 1 h

Huomaa: Tiedot voivat vaihdella ajoneuvon ja mallin mukaan.



Vanteet ja renkaat



Talvutuotteet



Vinsit



Laukut ja tuulisuojat



Sähköosat



Jousitus ja voimansiirto



Pakoputket ja suutinsarjat



Ohjaus



Rungon osat ja peitteet



Jarrupalat ja rattaat



Moottori



Variaattorin osat



Maatalous-tarvikkeet



Kärryt ja reet

ATV





LUMIKETJUT



Vanteet ja renkaat



Talvituotteet



Vinssit



Laukut ja tuulisuojat



Sähköosat



Jousitus ja voimansiirto



Pakoputket ja suutinsarjat



Ohjaukset



Rungon osat ja peitteet



Jarrupalat ja rattaat



Moottori



Variaattorin osat



Maatalous-tarvikkeet



Kärryt ja reet



PEG

Poikkitaiksetju joka neljännessä sivulenkissä

Tuotenumero	Lketjuparin mitat	Ovh./pari
74-133515	130x36cm	76,30
74-133516	137x36cm	81,30
74-133517	142x41cm	86,30

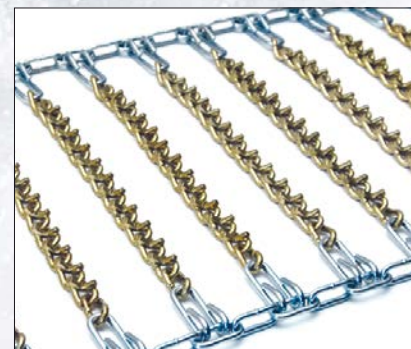

Diamond V-Bar

Tuotenumero	Lumiketjuparin mitat	Ovh./pari
74-133530	130x36cm	108,00
74-133531	137x36cm	118,00
74-133532	142x41cm	122,00
74-133533	150x41cm	125,00
74-133534	175x46cm	129,00

Diamond Peg

Tuotenumero	Lumiketjuparin mitat	Ovh./pari
74-133520	130x36cm	133,10
74-133521	137x36cm	153,30
74-133522	142x41cm	157,30
74-133523	150x41cm	193,60
74-133524	175x46cm	218,30

Agressor

Poikkitaiksetju joka toisessa sivulenkissä.

Tuotenumero	Lketjuparin mitat	Ovh./pari
74-133568	135x25cm	111,90
74-133569	160x28cm	116,90
74-133570	130x36cm	116,90
74-133571	137x36cm	121,90
74-133572	142x41cm	127,10
74-133573	150x41cm	132,10
74-133574	175x46cm	132,10

Sopivuudet

Lumiketju	Renkaan mitat
130x36cm	20x10-8,22x10-8,22x11-8,20x10-9,22x10-9,22x11-9,22x10-10,22x11-10,24x8-11
135x25cm	22x8-10,23x8-11
160x28cm	25x8-12 (Polaris)
137x36cm	24x10-11,24x11-11,24x9-11,23x10-12,25x8-12
142x41cm	25x12-9,25x11-10,25x12-10,25x10-12,25x12-12,26x10-12,26x12-12
150x41cm	27x9-12,27x11-12,27x10-12,27x12-12
175x46cm	28x10-12,28x12-12,30x10-12,30x12-12



LUMILINGOT



HUOM! Toimitustavaraa, toimitusaika n. 2 viikkoa.

Versatile 48"

- Leveys: 122cm
- Paino: 200kg
- Moottori: Kohler bensiinimoottori, 14hk (kahden vuoden takuu)
- Sähköstartilla
- Ohjauspaneeli
- Huoltovapaa vaihdelaatikko "Heavy Duty"
- Polttoainetankki: irrotettava, helppo täyttää.
- Työvälinerunko, säädettävä 182-280 cm



Tuotenro	Tuote	Hinta
77-7004	VERSATILE 48"	4729,-

Prestige 54"

- Leveys: 138cm
- Paino: 250kg
- Moottori: Kohler bensiinimoottori, 23 hv (kahden vuoden takuu)
- Sähköstartilla
- Ohjauspaneeli
- Huoltovapaa vaihdelaatikko "Heavy Duty"
- Polttoainetankki: irrotettava, helppo täyttää.
- Työvälinerunko, säädettävä 182-280 cm



Tuotenro	Tuote	Hinta
77-7003	PRESTIGE 54"	6442,-

Vantage 66"

- Leveys: 168cm
- Paino: 326kg
- Moottori: Kohler bensiinimoottori, 23 hv (kahden vuoden takuu)
- Sähköstartilla
- Ohjauspaneeli
- Huoltovapaa vaihdelaattikkoa "Heavy Duty"
- Polttoainetankki(8L): irrotettava, helppo täyttää
- Työvälinerunko, säädettävä 182-280 cm



Tuotenro	Tuote	Hinta
77-7005	VANTAGE 66"	7551,-



Vanteet ja renkaat



Talvituotteet



Vinsit



Laukut ja tuulisuojat



Sähköosat



Jousitus ja voimansiirto



Pakoputket ja suutinsarjat



Ohjaus



Rungon osat ja peitteet



Jarrupalat ja rattaat



Moottori



Variaattorin osat



Maatalous-tarvikkeet



Kärkyt ja reet

VARAOSAT

Tuotenro	Tuotteen nimi	Hinta
77-103999	Murtopultti / lukitusmutteri 10pakk.(nailon) (puha)	19,20
77-104000	Murtopultti / lukitusmutteri 10pakk. (nailon) (kierukka)	23,20
77-106167	Varahihna Vantage 48"& Prestige 54" 2011-	45,30
77-7006	belt snowblower versatile 48" 2008-2010 (A-39)	41,50
77-7007	belt snowblower PRESTIGE 54" 2008-10 (B-41)	59,00
77-7008	TIMING BELT VANTAGE 48" & PRESTIGE 54" H+D 600 8M-30	63,30
77-7009	V-HIHNA VANTAGE 48" & PRESTIGE 54" 2011- BX-55	44,50





Vanteet ja renkaat



Talvituotteet



Vinssit



Laukut ja tuulisuojat



Sähköosat



Jousitus ja voimansiirto



Pakoputket ja suutinsarjat



Ohjaukset



Rungon osat ja peitteet



Jarrupalat ja rattaat



Moottori



Variaattorin osat



Maataloustarvikkeet



Kärryt ja reet



MAXI GRIP™

MAXIGRIP -nastat

HM 11 - Skootterit, mopot, mönkijät

Tuotenro	Tuote	Pakkauskoko	Ovh.
74-1100	HM 11 NASTASARJA	24pakk.	23,20
74-1101	HM 11 NASTASARJA	150pakk.	105,70

HM 11R - Skootterit, mopot, mönkijät

Sama kuin HM 11, pidemällä nastalla, sis. asennustyökälyn.

Tuotenro	Tuote	Pakkauskoko	Ovh.
74-1102	HM 11 R NASTASARJA	100pakk.	99,70

HM 15 - Crossipyörät, pikkutraktorit, mönkijät

Tuotenro	Tuote	Pakkauskoko	Ovh.
74-1500	HM 15 NASTASARJA	100pakk.	68,10
74-1501	HM 15 NASTASARJA	150pakk.	106,70

HM 18 - Traktorit, trukit, pienkuormaajat, moottorikelkat

Tuotenro	Tuote	Pakkauskoko	Ovh.
74-1800	HM 18 NASTASARJA	100pakk.	79,30
74-1801	HM 18 NASTASARJA	150pakk.	122,90

HM 18R - Pidemmällä nastalla. sis. asennustyökälyn

Tuotenro	Tuote	Pakkauskoko	Ovh.
74-1888-1	HM 18R -nastasarja	100pakk.	120,00

uutuus!

KOVAMETALLINASTAT AMMATTIKÄYTTÖÖN

Nastat voidaan asentaa myös vanhoihin renkaisiin jos renkaissa on vain tarpeeksi kuviota jäljellä. Nastat on asennettava tarpeeksi syväälle siten, että ne nousevat vain 2-3mm esille renkaan kuvion ulkopinnasta. Nastoja on helppo poistaa ja lisätä tarpeen mukaan. Ne eivät kuluta rengasta. Työstä selviää helposti käyttämällä esim. akkuporakonetta.

Pakkauksen mukana tulee asennustyökäly.

HM 25 - traktorit, kuormaajat, moottorikelkat

Tuotenro	Tuote	Pakkauskoko	Ovh.
74-2500	HM 25 NASTASARJA	100pakk.	92,50
74-2501	HM 25 NASTASARJA	150pakk.	124,00

HM 30 - traktorit, kuormaajat, taajamakoneet

Tuotenro	Tuote	Pakkauskoko	Ovh.
74-3000	HM 30 NASTASARJA	100pakk.	109,70
74-3001	HM 30 NASTASARJA	150pakk.	135,10

Asennustyökälyt

Tuotenro	Tuote	Ovh.
74-1200	ASENNUSTYÖKÄLY HM 15,18,25	11,10
74-1201	ASENNUSTYÖKÄLY HM 11	8,10
74-1202	ASENNUSTYÖKÄLY HM 30	13,30

BRONCO

ATV COMPONENTS

BRONCO -nastat

Tuotenro	Tuote	Hinta
74-12604	BRONCO NASTASARJA 250kpl 5mm+12mm, koko pit. 17mm	40,70
74-12604-1	BRONCO NASTASARJA 250kpl 5mm+19mm, koko pit. 24mm	45,70



ATV

KUNNOSSAPITO

Levitin Universal

uutuus!

- Levitin Universal
- Helppo ja kätevä yleislevitin lannoitteiden, suolan, hiekan ym. Levittämiseen.
- Säädettävä levitysleveys 1,5m -13,5m
- Säiliön tilavuus 63L.



Tuotenumero	Tuote	Hinta
77-1-5301845	Levitin ATV-DMS 12V	629,00

BRONCO ATV COMPONENTS

SUORAT PUSKULEVYT



Puskulevy

uutuus!

Tuotenumero	Mitat	Hinta
75-12470	Puskulevy 136x40cm	239,50
75-12469	Puskulevy 152x40cm	264,20
75-12459	Puskulevy 156x45cm oranssi	329,00



Puskulevy 165x45cm

Uusi 165cm leveä Bronco puskulevy on suunniteltu kestäämään kovaa käyttöä. Sis. merkiantennit.

Tuotenumero	Hinta
75-12468	345,00

KARTIOPUSKULEVYT



Kartiopuskulevy 145cm

Tuotenumero	Hinta
75-12460	376,00

PUSKULEVYSARJA: BRONCO GEN II FRONT MOUNTED



BRONCO ATV COMPONENTS

Työvälinerunko Gen II

- Erittäin helppo asennus ja irroitus - onnistuu ilman työkaluja
- Asennetaan etuosaan: Ei häiritse asennettuna muuta mönkijän käyttöä
- Ei vaikuta mönkijän maavaraan

Tuotenumero	Ovh.
75-12400	230,90

Merkkikohtaiset kiinnityssarjat

Arctic Cat	Malli	Tuotenumero	Hinta
2005-11	400/500/650/700/1000	75-12401	99,90
Can-Am		Tuotenumero	Hinta
2005-13	400/500/650/800	75-12402	99,90
Honda		Tuotenumero	Hinta
2005-11	500 Foreman, Rubicon	75-12404	99,90
2003-13	650/680 Rincon	75-12403	99,90
Polaris		Tuotenumero	Hinta
2006-10	500-800 Sportsman	75-12406	130,90
Yamaha		Tuotenumero	Hinta
2007-13	550/700 Grizzly	75-12405	99,90



Vanteet ja renkaat



Talvutuotteet



Vinsit



Laukut ja tuulisuojat



Sähköosat



Jousitus ja voimansiirto



Pakoputket ja suutinsarjat



Ohjaus



Rungon osat ja peitteet



Jarrupalat ja rattaat



Moottori



Variaattorin osat



Maatalous-tarvikkeet



Kärryt ja reet

ATV





Työvälinerunko

Perinteinen hyvin toimiva työvälinerunko.
Huom! Toimii ainoastaan vinsillä!

Tuotenumero	Tuote	Hinta
75-12471-0	Työvälinerunko, pitempi malli +7,5 cm	229,00

Merkkikohtaiset kiinnityssarjat

Arctic Cat			Hinta	Linhai			Hinta
75-12475			82,70	75-12478			82,70
2006-14	400	4 x 4			LINHAI 300	4 x 4	
2005-08	500	4 x 4			LINHAI 400	4 x 4	
2009-14	550	4 x 4			LINHAI 500 EFI	4 x 4	
2005-14	650	4 x 4		75-12492			89,80
2006-14	700	4 x 4			LINHAI 400 IRS	4 x 4	
2008-14	1000 THUNDER CAT	4 x 4			LINHAI 550 EFI	4 x 4	
Can-Am/Bombardier			Hinta	Polaris			Hinta
75-12477	G1		82,70	75-12472			82,80
2005-12	400 Outlander HO	4 x 4		2005	330 ATP AWD Auto		
2008-12	500 Renegade	4 x 4		2003-05	330 Magnum	2 x 4, 4 x 4	
2007-12	500 Outlander	4 x 4		2002-04	400 Sportsman	4 x 4	
2006-12	650 Outlander	4 x 4		2005	400 Sportsman AWD	4 x 4	
2006-12	800 Outlander	4 x 4		2008-12	400 Sportsman H.O.	4 x 4	
2007-12	Renegade 800	4 x 4		2006-07	450 Sportsman AWD	4 x 4	
75-12484	G2		89,80	2004-05	500 H.O. ATP	4 x 4	
2012-	1000 Renegade, Outlander XT	4 x 4		2005-07	500 H.O. AWD	4 x 4	
2013-	500-1000 (G2 Runko)			2008-10	500 Sportsman EFI	4 x 4	
75-12499	UUTUUS!		89,80	2002-12	500 Sportsman H.O.	4 x 4	
2009-	400 Outlander Max			2003-04	600 Twin Sportsman	4 x 4	
2009-	500 Outlander Max			2002-08	700 Twin Sportsman , X2	4 x 4	
				2005-12	800 Sportsman EFI AWD, H.O.	4 x 4	
Catvic			Hinta	75-12482			82,70
75-12479			89,80	2009-14	550 Sportsman XP	4 x 4	
2006-	400			2009-14	850 Sportsman XP	4 x 4	
Cectek			Hinta	2009-14	850 Scrambler		
75-12496			89,80	75-12493			89,80
	CECTEK 500 EFI GLADIATOR, QUADRIFT	4 x 4			RANGER 400 UTV	4 x 4	
	CECTEK 500 EFI KINGCOBRA	4 x 4		75-12494			89,80
CF Moto			Hinta		RANGER 800 RZR UTV	4 x 4	
75-12487			89,80	75-12495			89,80
	CF MOTO 500, 500 X5-A	4 x 4			RANGER 900 RZR XP UTV	4 x 4	
	CF MOTO 625	4 x 4		75-12501			89,80
	CF MOTO X6	4 x 4			570 Sportsman	4 x 4	
Dinli			Hinta	Suzuki			Hinta
75-12488			89,80	75-12478			82,70
	700 Centhor, Long	4 x 4		2008-10	450 King Quad	4 x 4	
	800 Centhor II	4 x 4		2009-13	500 King Quad	4 x 4	
Goes			Hinta	2005-07	700 King Quad	4 x 4	
75-12487			89,80	2008-13	750 King Quad	4 x 4	
	Goes 520, Max	4 x 4		Yamaha			Hinta
	Goes 625i, Max	4 x 4		75-12479			89,80
Honda			Hinta	2004-06	350 Bruin	2 x 4, 4 x 4	
75-12481			82,70	2007-11	YFM 350i Grizzly	4 x 4	
2007-13	TRX 420 FE, FM	4 x 4		2003-06	Kodiak 400	4 x 4	
75-12476			82,70	2007-13	450 Grizzly IRS	4 x 4	
2005-11	TRX 500 FPE Foreman	4 x 4		2003-06	Kodiak 450	4 x 4	
2005-11	TRX 500 FA Rubicon	4 x 4		75-12480			89,80
75-12485	UUTUUS!		82,70	2006-	450 Wolverine	4 x 4	
2014	TRX 420			75-12473			82,70
2012-	TRX 500 FPE Foreman	4 x 4		2008-11	550 Grizzly	4 x 4	
2012-	TRX 500 FA Rubicon	4 x 4		2002-07	YFM 660 FP Grizzly	4 x 4	
75-12486	UUTUUS!		89,80	2008	YFM 660 FP Grizzly	4 x 4	
2003-05	TRX 650 RINCON	4 x 4		2007-11	YFM 700 Grizzly FI Auto	4 x 4	
2006-14	TRX 680 RINCON	4 x 4		75-12498			89,80
Kawasaki			Hinta	2012-13	Grizzly 550, 700		
75-12474			82,70	75-12497			89,80
2006-09	650i Brute Force	4 x 4			700 RHINO UTV		
2005-14	750i Brute Force EFI	4 x 4		Yleismalli			Hinta
Kymco			Hinta	75-12483			89,80
75-12490			89,80				
	MXU 500 IRS	4 x 4					

Sopii 75% kaikista malleista



Vanteet ja renkaat



Talvituet



Vinsit



Laukut ja tuulisuojat



Sähköosat



Jousitus ja voimansiirto



Pakoputket ja suutinsarjat



Ohjaukset



Rungon osat ja peitteet



Jarrupalat ja rattaat



Moottori



Variaattorin osat



Maatalous-tarvikkeet



Kärryt ja reet

ATV

TYÖVÄLINERUNGON VARAOSAT JA LISÄVARUSTEET



Työvälinerungon jatkopala

- Pituus 38 cm.

Tuoteno	Hinta
75-12471-4	120,00



Työvälinerungon pikakiinnikesarja

- Pituus 38 cm.

Tuoteno	Hinta
75-12471-5	59,50



Lukkosokkasarja

Tuoteno	Hinta
75-12471-3	14,20

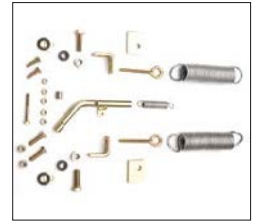

Työvälinerungon ruuvisarja

Tuoteno	Hinta
75-12471-2	33,30

PUSKULEVYN VARAOSAT JA LISÄVARUSTEET

Puskulevy

Tuoteno	Mitat	Hinta
75-12470-136	Puskulevyn varaterä 136cm	33,30
75-12470-152	Puskulevyn varaterä 152cm	37,40



Kulmalevy

Tuoteno	Mitat	Hinta
75-12470-2	Puskulevyn kulmalevy	42,40



Merkkiantennit

Tuoteno	Hinta
75-12468-1	22,20



Palautusjouset

Tuoteno	Hinta
75-12471-1	7,60



Tukijalkasarja

Tuoteno	Hinta
75-12470-1	45,40



Vanteet ja renkaat



Talvituotteet



Vinsit



Laukut ja tuulisuojat



Sähköosat



Jousitus ja voimansiirto



Pakoputket ja suutinsarjat



Ohjaukset



Runگون osat ja peitteet



Jarrupalat ja rattaat



Moottori



Variaattorin osat



Maataloustarvikkeet



Kärryt ja reet

ATV





MERKKIKOHTAISET KIINNITYSSARJAT

Cycle Country

Kaikkien kiinnityssarjojen hinta 101,70



Vanteet ja renkaat



Talvituotteet



Vinssit



Laukut ja tuulisuojat



Sähköosat



Jousitus ja voimansiirto



Pakoputket ja suutinsarjat



Ohjaukset



Rungon osat ja peitteet



Jarrupalat ja rattaat



Moottori



Variaattorin osat



Maatalous-tarvikkeet



Kärryt ja reet

Arctic Cat	Vuosim.		Tuotenro.
Atv			
250	2001-05	4 x 4	75-6510
250	-2003	2 x 4	75-6510
250	2006-07	2 x 4	75-5531
300	1998-01	2 x 4	75-6510
300	2002-05	4 x 4	75-6510
366	2008-11	4 x 4	75-6570
375 Automatic	2002	4 x 4	75-6510
400	1998-00	2 x 4	75-6510
400	1998-02	4 x 4	75-6510
400	2003	4 x 4	75-6530
400	2004-05	4 x 4	75-6540
400i	2002-04	4 x 4	75-6540
454	1996-98	2 x 4, 4 x 4	75-6510
500	1998-02	4 x 4	75-6510
500	2003-04	4 x 4	75-6540
500i	2002-04	4 x 4	75-6540
650	2004	4 x 4	75-6540
Utv			
Kaikki Prowler	2006-11	4 x 4	75-6560
Can-Am/Bombardier	Vuosim.		Tuotenro.
200 Rally	2003-06	2 x 4	75-7521
500 Quest	2003	4 x 4	75-7511
500 Traxter	1999-05	4 x 4	75-7511
650 Quest	2002-04	4 x 4	75-7511
650 Traxter	2005	4 x 4	75-7511
Catvic	Vuosim.		Tuotenro.
400	2006-		75-5590
CF Moto	Vuosim.		Tuotenro.
500	2006-11		75-5511
Eton	Vuosim.		Tuotenro.
Challenger 150			75-8511
Yukon II CXL-150	2006		75-8511
YXL 150 Yukon	2001	4 x 4	75-8511
Vector 250	2006		75-8520
GOES	Vuosim.		Tuotenro.
520, Max	2007-	4 x 4	75-5511
Honda	Vuosim.		Tuotenro.
TRX 350	1986-89	4 x 4	75-1540
Kawasaki	Vuosim.		Tuotenro.
250 Bayou	2002-08	2 x 4	75-2560
360 Prairie	2002-12	4 x 4	75-2590
400 Klf	1993-99	4 x 4	75-2520
650 Prairie	2002-03	4 x 4	75-2570
650 Brute Force	2005-11	4 x 4	75-2570
650i Brute Force	2006-09	4 x 4	75-2610
700 Prairie	2004-06	4 x 4	75-2570
700 Kfx	2004-07	2 x 4	75-2600
750i Brute Force EFI	2005-12	4 x 4	75-2610
Kymco	Vuosim.		Tuotenro.
MXV 250	2005-		75-8511
MXU 300	2006		75-8511
MXU 375	2009-10		75-8620
MXU 450i	2012		75-8620
MXU 500	2007-11		75-8530
Polaris	Vuosim.		Tuotenro.
Saw Tooth	2006	2 x 4	75-3650
250 Trailblazer	1999-05	2 x 4	75-3541
250 Xplorer	-2002	4 x 4	75-3562
300	1996-99	2 x 4, 4 x 4	75-3530
325 Trail Boss	2000-01	2 x 4	75-3510
325 Magnum	-2001	2 x 4, 4 x 4	75-3570

Polaris	Vuosim.		Tuotenro.
335 Worker	-2000	4 x 4	75-3550
400 Xpress	1997	2 x 4	75-3530
400 Xplorer	1996-98	4 x 4	75-3530
400 Sport	1999	2 x 4	75-3541
400 Scrambler	1998-02	2 x 4, 4 x 4	75-3541
400 Sportsman H.O.	2008-10	4 x 4	75-3640
400 Trailblazer	2003	2 x 4	75-3541
400 Worker	2001	4 x 4	75-3550
400 Xplorer	1999-01	4 x 4	75-3562
425 Magnum	1995-98	2 x 4, 4 x 4, 6 x 6	75-3520
425 Xpedition	2000	4 x 4	75-3570
445 Diesel	1999	4 x 4	75-3550
500 Magnum, RMK	1999-01	4 x 4	75-3570
500 Scrambler	1997	4 x 4	75-3520
500 Scrambler, H.O.	1998-05	2 x 4, 4 x 4	75-3541
500 Xplorer	1997	4 x 4	75-3550
500 Worker H.O.	-2001	4 x 4	75-3550
500 Worker H.O. Ducks unlimited	2001	4 x 4	75-3550
500 Worker RSE	-2002	4 x 4	75-3550
500 Worker	2000-02	6 x 6	75-3562
Suzuki	Vuosim.		Tuotenro.
250 LT 4WD	1997-01	4 x 4	75-4521
250 LTF	1988-01	2 x 4	75-4521
250 Ozark	2002-06	2 x 4	75-4570
280 King Quad	-1998	4 x 4	75-4521
300 King Quad	1999-01	4 x 4	75-4521
300 King Quad	2002	4 x 4	75-4560
700 Twin Peaks	2004	4 x 4	75-2570
TGB	Vuosim.		Tuotenro.
Outback 425	08-09	4 x 4	75-8610
Yamaha	Vuosim.		Tuotenro.
Atv			
YFM 250 XLC Beartracker	-2004	4 x 4	75-5560
250 Bruin	2005	2 x 4	75-5610
YFB Timberwolf	-1998	2 x 4	75-5570
YFB Timberwolf	-1999	4 x 4	75-5570
350 Bruin	2004-06	2 x 4, 4 x 4	75-5590
YFM 350 OUH Big Bear	1993-98	2 x 4	75-5540
YFM 350 FWT SE Big Bear	1997	4 x 4	75-5540
YFM 350 FWT Big Bear	-1996	4 x 4	75-5540
YFM 350 UBL	1999	2 x 4	75-5531
YFM 350 FWBJ Big Bear	1997-99	4 x 4	75-5531
YFM 350 FX Wolverine	1998-05	4 x 4	75-5531
YFM 350 Raptor	2005-06	2 x 4	75-5531
YFM 350i Grizzly	2007-12	4 x 4	75-5590
Kodiak 400	2003-06	4 x 4	75-5590
YFM 400 FWE Kodiak	1993-98	4 x 4	75-5540
YFM 400 FWBL Kodiak	1999	4 x 4	75-5531
YFM 400 AMC Kodiak, automat	2000-01	2 x 4	75-5511
YFM 400 Big Bear IRS	2007-08	4 x 4	75-5531
YFM 400 FWAM Kodiak	2000-02	4 x 4	75-5511
YFM 400 NMC Big Bear	2000-05	2 x 4	75-5531
YFM 400 FWNM Big Bear	2000-12	4 x 4	75-5531
450 Grizzly IRS	2007-12	4 x 4	75-5590
Kodiak 450	2003-06	4 x 4	75-5590
YFM 600 FWAK Grizzly	1998-01	4 x 4	75-5520
YFM 660 FP Grizzly	2002-07	4 x 4	75-5511
YFM 700 Grizzly FI Auto	2007	4 x 4	75-5511
Utv			
450 Rhino	06-07	4 x 4	75-5620
660 Rhino	04-05	4 x 4	75-5600
660 Rhino	06-07	4 x 4	75-5620

ATV



Vanteet ja renkaat



Talvituotteet



Vinssit



Laukut ja tuulisuojat



Sähköosat



Jousitus ja voimansiirto



Pakoputket ja suutinsarjat



Ohjaus



Rungon osat ja peitteet



Jarrupalat ja rattaat



Moottori



Variaattorin osat



Maatalous-tarvikkeet



Kärryt ja reet

BRONCO

ATV COMPONENTS

GENERATION II WINCH

VINSSIT

Täysin uudistettu Generation 2 mallisto on varma valinta! Uusi vesitiivis rakenne merkitsee luotettavuutta vaativissa olosuhteissa. Tehdastakuu 2 vuotta.



73-620
73-621



73-622

Bronco 2500 Gen II

- CE-Hyväksytty
- vetokyky: 1133kg
- Vaijeriohjain
- Kolmivaiheinen planeettapyörästö
- 10m x 5mm synteettinen köysi.
- langaton kauko-ohjain + ohjaustankoon sijoitettava kytkin
- Tehdastakuu: 2 vuotta

Bronco 3500 Gen II

- CE-Hyväksytty
- vetokyky: 1460kg
- Vaijeriohjain
- Kolmivaiheinen planeettapyörästö
- 10m x 5mm synteettinen köysi.
- langaton kauko-ohjain + ohjaustankoon sijoitettava kytkin
- Tehdastakuu: 2 vuotta

Bronco 2500 Gen I

- CE-Hyväksytty
- Vetokyky: 1133kg
- 15m x 5mm teräsvaijeri
- Langaton kauko-ohjain + ohjaustankoon sijoitettava kytkin
- Tehdastakuu: 2 vuotta

Tuotenumro	Hinta
73-620	253,00

Tuotenumro	Hinta
73-621	272,00

Tuotenumro	Hinta
73-622	215,00

Bronco 4500 Gen II

- CE-Hyväksytty
- Vetokyky: 2040kg
- 15m x 5,5mm Vaijeri
- Langaton kauko-ohjain+ohjaustankoon sijoitettava kytkin
- Vesitiivis
- Tehdastakuu: 2 vuotta



Tuotenumro	Hinta
73-625	313,00



Bronco 1500 Gen I

- Laatu luokitus: CE-merkintä
- vetokyky: 680kg
- 8m x 5mm teräsvaijeri.
- langaton kauko-ohjain + ohjaustankoon sijoitettava kytkin

Tuotenumro	Hinta
73-623	173,00



VINSSIT



Vanteet ja renkaat



Talvituotteet



Vinssit



Laukut ja tuulisuojat



Sähköosat



Jousitus ja voimansiirto



Pakoputket ja suutinsarjat



Ohjaus



Rungon osat ja peitteet



Jarrupalat ja rattaat



Moottori



Variaattorin osat



Maatalous-tarvikkeet



Kärryt ja reet

ATV

BRONCO

ATV COMPONENTS



Bronco 2000 Portable

uutuus!

- Laatuluokitus: CE-merkintä
- vetokyky: 907 kg
- 15m x 4mm teräsvaijeri.
- Tehdastakuu 2v.

Tuotenro	Hinta
73-626	229,-



Bronco 1500 Strap

uutuus!

- Laatuluokitus: CE-merkintä
- vetokyky: 680 kg
- 1m x 25 mm nauha (tarkoitettu lumi-levyn nostamiseen)
- Tehdastakuu 2v.

Tuotenro	Hinta
73-627	219,-

BRONCO

ATV COMPONENTS

VINSSIEN VARAOSAT JA TARVIKKEET



Sakkelit

Sakkelin avulla liität turvallisesti esim. Väkipyörän tai puunsuojausliinan vinssin vaijeriin.

Tuotenro	Tuote	Hinta
M08-329-08	Sakkeli 8mm , Galvanoitu	1,05
M08-329-10	Sakkeli 10mm , Galvanoitu	1,35



Väkipyörät

Väkipyörän avulla saat tuplattua vinssin vetokyky.

Tuotenro	Tuote	Hinta
73-652	Väkipyörä koukulla, 3400kg	62,00



Juontoketju

Juontoketjun avulla voit vetää myös hankalan muotoisia tai teräväreunaisia taakkoja.

Tuotenro	Tuote	Hinta
73-654	Juontoketju 2,1m	58,00



Salpakoukku

Tuotenro	Tuote	Hinta
73-611-5	Salpakoukku	12,10



Koukun topparikumi

Tuotenro	Ovh.
73-611-6	19,30



Juontosakset

Sähkösinkitty, Puun maks. Halk. 30cm

Tuotenro	Tuote	Hinta
73-1400	Juontosakset	69,00
73-1401	Juontosakset kahvalla	76,00

**Vinssien
lisävarustelaukku**

Sisältää: Hihnat, lukot, ym.



Tuotenumero	Ovh.
73-607	60,90

**Vinssin
suojapussi**

- Suojaa vinssiä likaantumiselta
- Materiaali: 300d polyester



Tuotenumero	Hinta
73-612	15,30



Vinssin vaijeri 15m

Tuotenumero	Hinta
73-611-4	39,70



Synteettinen köysi

- Erittäin luja, 5,5mm x 10m
- Suurin kuorma 3600 kg

Tuotenumero	Tuote	Hinta
73-611-12	Synteettinen köysi	59,90



Synteettinen köysi

- 10m x 5mm
- Suurin kuorma 1900 kg

Tuotenumero	Pituus	Hinta
73-611-7	10m	49,90
73-611-11	15,3m	79,00



Rullaohjain

Isolla rullalla varustettu rullaohjain pidentää vaijerin tai köyden käyttöikää puskulevykäytössä.

Tuotenumero	Tuote	Hinta
73-653	Rullaohjain HD	47,50



Vinssin vaijeriohjain

Tuotenumero	Hinta
73-950	36,50



Pikajohtosarja

Johtosarja vinssin asennukseen esim. Tukkipölyyn. Sisältää: Trukkiliittimet ja johdot.

Tuotenumero	Tuote	Hinta
73-611-10	Pikajohtosarja	62,00



**Alumiininen
ohjausportti**

Tuotenumero	Ovh.
73-950-2	24,20



**Kaukosäädinsarja
Bronco Gen II**

Tuotenumero	Tuote	Hinta
73-611-9	Kaukosäädinsrj	54,90
73-611-13	Paristo	3,90



**Vinssin rele
Bronco Gen II**

Tuotenumero	Hinta
73-611-8	54,90



Katkaisija, Bronco

Tuotenumero	Ovh.
73-611-3	29,50



Vanteet ja renkaat



Talvituotteet



Vinssit



Laukut ja tuulisuojat



Sähköosat



Jousitus ja voimansiirto



Pakoputket ja suutinsarjat



Ohjaukset



Rungon osat ja peitteet



Jarrupalat ja rattaat



Moottori



Variaattorin osat



Maatalous-tarvikkeet



Kärryt ja reet



MERKKIKOHTAISET KIINNITYSSARJAT

BRONCO
ATV COMPONENTS



Vanteet ja renkaat



Talvituotteet



Vinssit



Laukut ja tuulisuojat



Sähköosot



Jousitus ja voimansiirto



Pakoputket ja suutinsarjat



Ohjaus

KIINNITYSSARJAT ETEEN

CAN-AM	Tuotenro	Hinta
MAVERICK	73-1319	99,00
OUTLANDER 400, 650, MAX G1	73-1300	69,60
OUTLANDER 800,R,MAX	73-1300	69,60
RENEGADE 500	73-1307	89,80
RENEGADE 800R	73-1307	89,80
RENEGADE 1000 G2 2012-	73-1317	99,00
CECTEK		
500 KING COBRA	73-1308	82,70
CF MOTO		
CF MOTO 500	73-1309	82,70
CF MOTO Z6	73-1310	82,70
HONDA		
TRX 420	73-1301	69,60
TRX 420 2014-	73-1320	69,60
TRX 500 RUBICON/FOREMAN -2011	73-1312	82,70
TRX 500 FE/FPE 2012-13	73-1311	82,70
TRX 500 FE/FPE 2014-	73-1320	69,60
RINCON 650,680	73-1302	82,70
LINHAI		
400 IRS	73-1313	82,70



BRONCO
ATV COMPONENTS

POLARIS

400,500,800 SPORTSMAN -2010	73-1318	89,80
400,500,800 SPORTSMAN 2011-	73-1303	69,60
550,850 XP SPORTSMAN 2009-12	73-1303	69,60
RANGER 800 RZR	73-1314	89,80
RANGER 400 2011-2012	73-1315	89,80
RANGER 900 RZR XP	73-1316	89,80

SUZUKI

KING QUAD 450,700,750	73-1304	69,60
-----------------------	---------	-------

YAMAHA

GRIZZLY 350,450	73-1305	69,60
GRIZZLY 550,700	73-1306	69,60

KIINNITYSSARJAT TAAKSE

ARCTIC CAT	Tuotenro	Hinta
400,550,700	73-1342	89,80
CAN-AM		
500,650,800,MAX OUTLANDER	73-1330	82,70
650,800,1000 OUTLANDER (G2 RUNKO)	73-1341	89,80
CF MOTO		
CF MOTO 500	73-1331	82,70
DINLI		
700,800 CENTHOR	73-1332	82,70
GOES		
625,625 MAX	73-1333	137,20
KYMCO		
MXU 500 IRS	73-1339	82,70
HONDA		
RINCON 650,680	73-1340	89,80
KAWASAKI		
BRUTE FORCE 650,750	73-1334	92,80



BRONCO
ATV COMPONENTS

POLARIS

500,800 SPORTSMAN 2011-	73-1343	89,80
570 SPORTSMAN 2014-	73-1343	89,80
RANGER 800 RZR	73-1335	89,80
550,850 XP,X2 SPORTSMAN	73-1336	137,20
RANGER 400 2011-2012	73-1337	96,80

SUZUKI

KING QUAD 450,700,750	73-1338	82,70
-----------------------	---------	-------

PERÄKOUKUN PIDENNYSSARJAT

CAN-AM	Tuotenro	Hinta
OUTLANDER, MAX	73-1360	84,00
CF-MOTO		
CF MOTO 500	73-1361	89,80
HONDA		
TRX 650, 680	73-1364	84,00
SUZUKI		
KING QUAD 450,700,750	73-1362	89,80
POLARIS		
SPORTSMAN XP 550,850	73-1363	84,00
RANGER 400, 570, 800, 900	73-1365	136,00



BRONCO
ATV COMPONENTS

ATV



Arctic Cat	VM		Tuotenro	Hinta
250	-2001	2 x 4	73-951	129,00
250	2006-07	2 x 4	73-1009	112,50
300	-2001	4 x 4	73-951	129,00
375 Automatic	2002	4 x 4	73-952	129,00
400	-2000	2 x 4	73-953	129,00
400	-2001	4 x 4	73-953	129,00
400 Auto VP	2006-11	4 x 4	73-934	129,00
400 Automatic TBX	2005	4 x 4	73-934	129,00
400 Automatic TRV	2006-11	4 x 4	73-934	129,00
400i Automatic/Manual	2006-11	4 x 4	73-934	129,00
400i Auto TRV	2006-11	4 x 4	73-934	129,00
400i Manual	2006-11	4 x 4	73-934	129,00
454	-1998	4 x 4	73-952	129,00
500 Automatic	-2002	4 x 4	73-952	129,00
500 Automatic	2005	4 x 4	73-934	129,00
500i Auto	2006-11	4 x 4	73-934	129,00
500i TBX	2002	4 x 4	73-952	129,00
500i Automatic TRV	2006-11	4 x 4	73-934	129,00
550i Hi EFI	2006-11	4 x 4	73-934	129,00
650 Twin	2005	4 x 4	73-934	129,00
650 V2 4WD	2005-06	4 x 4	73-934	129,00
650 HI 4WD	2005-11	4 x 4	73-934	129,00
650 H1, Auto	2005-11	4 x 4	73-934	129,00
650i H1, Auto	2005-11	4 x 4	73-934	129,00
650 Prowler, XT	2006-08	4 x 4	73-8300	129,00
650i V2 Tony Stewart LE	2005-06	4 x 4	73-934	129,00
700i EFI, SE	2006-11	4 x 4	73-934	129,00
1000 Thundercat	2006-11	4 x 4	73-934	129,00
Can-Am/Bombardier	VM		Tuotenro	Hinta
200 Rally	2003		73-941	129,00
200 Rally	2005-06	2 x 4	73-1003	112,50
330 Outlander	2004-05	4 x 4	73-939	129,00
330 Outlander	2005	2 x 4	73-939	129,00
400 Outlander	2003-05	4 x 4	73-939	129,00
400 Outlander H.O	2006	4 x 4	73-939	129,00
400 Outlander Max	2004	4 x 4	73-941	129,00
400 Outlander Max	2005	4 x 4	73-939	129,00
500 Quest	2003	4 x 4	73-940	129,00
500 Traxter	99-04	4 x 4	73-940	129,00
500 Traxter Max	2003	4 x 4	73-940	129,00
500 Traxter Max Auto	2005	4 x 4	73-940	129,00
500 Traxter 5 Speed	2005	4 x 4	73-940	129,00
500 Traxter XT	2002-03	4 x 4	73-940	129,00
500 Traxter XL (Dump box)	2002-03	4 x 4	73-940	129,00
650 Quest	2002-04	4 x 4	73-940	129,00
650 Traxter	2005	4 x 4	73-940	129,00
Eton	VM		Tuotenro	Hinta
YXL 150 Yukon	2001-	2 x 4	73-937	129,00
Challenger 150	2001-	2 x 4	73-937	129,00
Honda	VM		Tuotenro	Hinta
250 Recon	1997-04	2 x 4	73-960	129,00
TRX 250 TE Recon ES	2003		73-960	129,00
TRX 250 Recon	2005-06	2 x 4	73-960	129,00
TRX 500 ES Foreman	2005-07	4 x 4	73-926	129,00
TRX 500 ES Rubicon	2005	4 x 4	73-925	129,00
TRX 500 Foreman Manual	2005-06	4 x 4	73-926	129,00
TRX 500 FA Rubicon	-2004	4 x 4	73-959	129,00
TRX 500 FA Rubicon	2005-06	4 x 4	73-925	129,00
TRX 500 FA Rubicon	2007-12	4 x 4	73-1013	112,50
Kawasaki	VM		Tuotenro	Hinta
250 Bayou	2002-06	2 x 4	73-1016	112,50
KLF 300	1993-01	4 x 4	73-961	129,00
KVF 300 PRAIRIE	1999-02	2 x 4, 4 x 4	73-963	129,00
360 Prairie	2002-12	4 x 4	73-999	129,00
KLF 400	1993-99	4 x 4	73-962	129,00
KVF 400 PRAIRIE	1999-02	4 x 4	73-964	129,00
Mule 550	1997,2002	2 x 4	73-992	129,00
KVF 650 Brute Force	2005-12	4 x 4	73-928	129,00
KVF 650 Brute Force V-Twin	2005-06	4 x 4	73-928	129,00
KVF 700 Twin Prairie	2005-06	4 x 4	73-924	129,00
750 Brute Force	2005-06	4 x 4	73-938	129,00

Kawasaki	VM		Tuotenro	Hinta
750i Brute Force	2005-06	4 x 4	73-938	129,00
Linhai	VM		Tuotenro	Hinta
250	2005	2 x 4	73-8300	112,50
Polaris	VM		Tuotenro	Hinta
200 Phoenix	2005	2 x 4	73-1004	112,50
200 Saw tooth	2006	2 x 4	73-1008	112,50
250 Trailblazer	1997-03	2 x 4	73-969	129,00
250 Trailblazer	2005	2 x 4	73-969	129,00
325 Magnum	-2001	2 x 4	73-970	129,00
325 Ranger	2002	2 x 4, 4 x 4	73-997	129,00
325 Trail boss	2002	2 x 4	73-998	129,00
330 Magnum	2003	2 x 4	73-989	129,00
330 Trail Boss	-2001	2 x 4	73-970	129,00
330 Trail Boss	2003	2 x 4	73-988	129,00
330 Trail Boss	2005	2 x 4	73-927	129,00
335 Worker	1999-00	4 x 4	73-968	129,00
400 XPRES	-1997	2 x 4	73-970	129,00
400 Scrambler	-2002	4 x 4	73-969	129,00
400 Scrambler	2002	2 x 4	73-969	129,00
400 Sport	1997-99	2 x 4	73-969	129,00
400 Sportsman AWD	2005	4 x 4	73-932	129,00
400 Trailblazer	2003	2 x 4	73-969	129,00
Ranger	2002-04	2 x 4, 4 x 4, 6 x 6	73-997	129,00
Ranger	2005	4 x 4	73-3220	129,00
Ranger	2005	6 x 6	73-3220	129,00
450 Sportsman AWD	2006	4 x 4	73-932	129,00
500 H.O. AWD	2005	4 x 4	73-932	129,00
500 Worker RSE	2003	4 x 4	73-965	129,00
500 Sportman	2005-06	4 x 4	73-932	129,00
500 Scrambler	1998-03	4 x 4	73-969	129,00
500 Scrambler	2001-05	2 x 4	73-969	129,00
550 Sportsman XP EFI	2009-12	4 x 4	73-1021	112,50
600 Twin Sportsman	2003	4 x 4	73-995	129,00
700 Ranger Twin	2005		73-3220	129,00
700 Twin Sportsman	2002-03		73-995	129,00
700 Twin Sportsman AWD, EFI	2005-07	4 x 4	73-932	129,00
700 Twin Sportsman EFI	2005-07		73-932	129,00
800 Sportsman	2005-06	4 x 4	73-932	129,00
850 Sportsman XP EFI	2009-12	4 x 4	73-1021	112,50
Suzuki	VM		Tuotenro	Hinta
250 Ozark	2002-06	2 x 4	73-936	129,00
LTF 400 F Eiger	2002-04	4 x 4	73-985	129,00
LTA 400 F Eiger	2005-08	4 x 4	73-931	129,00
LTA 500 QUADMASTER	-2001	4 x 4	73-973	129,00
LTA 500 F Vinson	2002-05	4 x 4	73-987	129,00
LTA 500 F Vinson	2006	4 x 4	73-1001	112,50
LTF 500 QUAD RUNNER	1998-02	4 x 4	73-973	129,00
TGB	VM		Tuotenro	Hinta
425 OUTBACK	2008-	4 x 4	73-1024	112,50
Yamaha	VM		Tuotenro	Hinta
250 Bruin	2005	2 x 4	73-929	129,00
YFM 350 FWT	-1996	4 x 4	73-976	129,00
YFM 350 UBL	1999	2 x 4	73-974	129,00
YFM 350 FWBJ	1997-99	4 x 4	73-974	129,00
YFM 350 FX Wolverine	-2005	4 x 4	73-945	129,00
400 Big Bear	2006	4 x 4	73-1005	112,50
YFM 400 Big Bear	2005	4 x 4	73-935	129,00
YFM 400 FWNM Big Bear	2000-06	4 x 4	73-982	129,00
YFM 400 NMC Big Bear	2000-06	2 x 4	73-982	129,00
YFM 400 FWAM Kodiak	1999	4 x 4	73-979	129,00
450 Rhino	2006-11	4 x 4	73-944	129,00
450 Wolverine	06-07	4 x 4	73-1000	112,50
YFM 600 FWAK Grizzly	1998-01	4 x 4	73-980	129,00



Vanteet ja renkaat



Talvituotteet



Vinsit



Laukut ja tuulisuojat



Sähköosat



Jousitus ja voimansiirto



Pakoputket ja suutinsarjat



Ohjauksen



Runnon osat ja peitteet



Jarrupalat ja rattaat



Moottori



Variaattorin osat



Maatalous-tarvikkeet



Kärryt ja reet

ATV





Vanteet ja renkaat



Talvituotteet



Vinssit



Laukut ja tuulisuojat



Sähköosat



Jousitus ja voimansiirto



Pakoputket ja suutinsarjat



Ohjaus



Rungon osat ja peitteet



Jarrupalat ja rattaat



Moottori



Variaattorin osat



Maatalous-tarvikkeet



Kärryt ja reet

ATV



KOVAT KULJETUSLAUKUT

Kimpex tunnetaan monesta asiasta, mutta erityisesti alan pisimmälle kehitetyistä kuljetuslaukuista. Ne ovat käytännöllisiä ja hyvin tehtyjä – ja muuttuvat pian erottamattomaksi osaksi mönkijääsi.

KIMPEX

TAAKSE

Kimpex Cargo

Yksi alan arvostetuimpia kuljetuslaukkuja. Käytännöllinen, simpelli, tilava. Sopii lähes kaikkiin mönkijöihin.

- Iskunkestävää ja tukevaa muovia
- Kiinnitetään tavaratelineeseen kiinnikesarjalla
- Tilavuus 60L
- Mitat: 89x53x29cm.



suosikkituote!

Tuotenro	Hinta
92-337	297,40

Kimpex Cargo Deluxe

Yksi alan arvostetuimpia kuljetuslaukkuja. Kannessa verkko tavaroiden näppärää kuljettamista varten. Päällä tukevat kiinnitystangot. Sopii lähes kaikkiin mönkijöihin.

- Iskunkestävää ja tukevaa muovia
- Kiinnitetään tavaratelineeseen kiinnikesarjalla
- Tilavuus 60L
- Mitat: 89x53x29cm.



suosikkituote!

Tuotenro	Hinta
92-337-1	327,70



Päällä kätevät kiinnitystangot





Vanteet ja renkaat



Talvutuotteet



Vinsit



Laukut ja tulisuojat



Sähköosat



Jousitus ja voimansiirto



Pakoputket ja suutinsarjat



Ohjaus



Rungon osat ja peitteet



Jarrupalat ja rattaat



Moottori



Variaattorin osat



Maatalous-tarvikkeet



Kärryt ja reet

Kimpex Dry Ride 2.0

Miellyttävä laukku pidemmillekin reissuille. Dry Ride 2.0 pitää tavaroista hyvää huolta, sillä se on vesitiivis ja. Tilaa mm. kahdelle kypärälle.

- Vesitiivis, Iskunkestävää ja tukevaa muovia
- Takavalo (LED) jarrutus ja peruutustoiminnoilla
- Kumilenkit sulkevat laukun luotettavasti
- Lukittavissa keskeltä
- Kiinnitetään tavaratelineeseen pikakiinnikesarjalla
- Mitat: 104x71x40cm

Tuotenumero	Hinta
92-344	545,-



Kimpex Outback

Erityisesti käyttäjien toivomusten mukaan kehitetty monikäyttöinen laukku. Laukun ulkopuolella on valmis paikka bensakanisterille.

- Iskunkestävää ja tukevaa muovia
- Takavalo
- Tilaa 5 l polttoainekannisterille.
- Kiinnitetään tavaratelineeseen pikakiinnikesarjalla
- Mitat: 107x71x43cm.

Tuotenumero	Hinta
92-338	334,70



KOVAT KULJETUSLAUKUT TAAKSE

SnoX kuljetuslaukku

- Iskunkestävää ja tukevaa muovia
- Suljetaan kahdella kumilenkillä - helppoa vaikka hanskat kädessä
- Mitat: 87x46x29cm.

Tuotenumero	Hinta
92-330	230,90





KOVAT KULJETUSLAUKUT

BRONCO

ATV COMPONENTS



Vanteet ja renkaat



Talvituotteet



Vinsit



Laukut ja tuulisuojat



Sähköosat



Jousitus ja voimansiirto



Pakoputket ja suutinsarjat



Ohjaus



Rungon osat ja peitteet



Jarrupalat ja rattaat



Moottori



Variaattorin osat



Maatalous-tarvikkeet



Kärryt ja reet

ETEEN

uutuus!

Kuljetuslaukku, Bronco, 85L

- Mitat: 85(L) x 42(W) x 31(H) cm
- Tilavuus: (85L)

Tuotenro	Hinta
92-349	236,-



TAAKSE



Bronco Standard

Suuri kuljetuslaukku, joka imaisee helposti bensakanisterin tai kylmälaukun. Tukevaa tekoa, valmistettu Kanadassa. Ergonomisesti muotoiltu. Ylös sijoitettu takavallo näkyy kauas.

- Takavallo
- Joustavat kiinnitysoljet pitävät sulkevat kannen luotettavasti
- Lukittavissa
- Mukana bensakanisteri
- Mitat: 107cm x 69cm x 43cm

Tuotenro	Hinta
92-346	426,-

Bronco Comfort

Suuri kuljetuslaukku, joka imaisee helposti bensakanisterin tai kylmälaukun. Tukeva laukku, valmistettu Kanadassa. Lämmitettävät kädensijat ja ergonominen muotoilu takaavat miellyttävän ajokokemuksen. Korkealle sijoitettu takavallo näkyy kauas.

- Takavallo
- Joustavat kiinnitysoljet pitävät kannen kiinni rajummassakin menossa
- Lukittavissa
- Mitat: 107cm x 82cm x 46cm

Tuotenro	Hinta
92-348	472,-



Bronco kuljetuslaukku 115 L

Valmistettu iskunkestävästä ja tukevasta muovista. Aerodynaaminen muotoilu. Vesitiivis, tilava ja monikäyttöinen laukku lukituksella. Tilavuus 115 l.

Tuotenro	Hinta
92-341	241,-

ATV

PEHMEÄT KULJETUSLAUKUT

Kaikki laukut on valmistettu kestävästä 500DN Cordurasta.



Takalaukku, Bronco

Mitat: 84x40x23cm

600 D Polyester

Tuotenro	Hinta
76-12050	44,40



Etulaukku, Bronco

Mitat: 84x40x23cm
600 D Polyester

Tuotenro	Hinta
76-12052	42,40



ATV Fender Pack

Tuotenro	Tuotteen nimi	Hinta
76-0214	Lokasuojalaukku, camo	36,-
76-0214-1	Lokasuojalaukku, musta	36,-



ATV Deluxe Rack Pack

Tuotenro	Tuotteen nimi	Hinta
76-0211	Pehmeä laukku, eteen Mitat: 76 x 30 x 30cm	130,10
76-0212	Pehmeä laukku, taakse Mitat: 86 x 40 x 22cm	146,20



Laukkusarja

Sisältää: Etulaukku, Takalaukku, Lokasuojalaukku, 100% Vesitiivis

Tuotenro	Hinta
76-12184	183,50



Tankkilaukku

Tuotenro	Tuotteen nimi	Hinta
76-0213	Tankkilaukku, musta	36,30

KULJETUSKORIT

Tukevat kuljetuskorit tavaroiden kuljettamiseen. Kiinnitetään tavaratelineeseen mukana tulevilla kiinnityssarjalla.



Kuljetuskori taakse

Mitat: 104x35x29 cm
Sis.kiinnityssarjan.

Tuotenro	Tuote	Hinta
76-0200-1	Bronco	173,40



Kuljetuskori taakse

Mitat: 104x70x14 cm
Sis.kiinnityssarjan.

Tuotenro	Tuote	Hinta
76-0205-1	Bronco	152,30

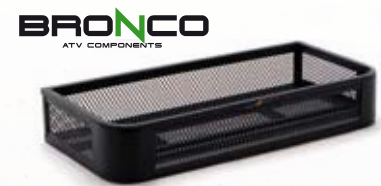

Kuljetuskori eteen

Mitat: 91x43x14 cm
Sis.kiinnityssarjan.

Tuotenro	Tuote	Hinta
76-0210-1	Bronco	142,20



Vanteet ja renkaat



Talvituotteet



Vinsit



Laukut ja tuulisuojat



Sähköosat



Jousitus ja voimansiirto



Pakoputket ja suutinsarjat



Ohjaus



Rungon osat ja peitteet



Jarrupalat ja rattaat



Moottori



Variaattorin osat



Maatalous-tarvikkeet



Kärryt ja reet

ATV





TELINEET JA LAUKKUIEN LISÄTARVIKKEET



Vanteet ja renkaat



Talvituotteet



Vinssit



Laukut ja tuulisuojat



Sähköosat



Jousitus ja voimansiirto



Pakoputket ja suutinsarjat



Ohjaus



Rungon osat ja peitteet



Jarrupalat ja rattaat



Moottori



Variaattorin osat



Maataloustarvikkeet



Kärryt ja reet

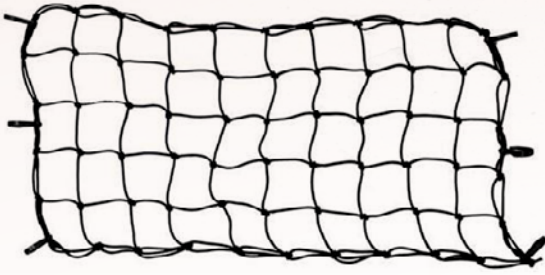

Tavaraverkko 50x100cm, 2 pakk.

Tuoteno	Ovh.
76-1214206	21,50/kpl



Muovinen Kuljetuskori, Bronco

- Mitat: 108x84x18cm
- Sis. Kiinnityssarjan.

Tuoteno	Ovh.
76-12199	167,00



Öljy- ja polttoainekannisteri

Tilavuus	Tuoteno	Hinta
6 L + 2,25 L	98-122-8	29,-

Moottorisahan/ polttoainekannisterin pidike

Uutuusmalli 76-0088-1 on tarkoitettu Stihl, Husqvarna ja Jonsered -merkin

Tuoteno	Tuotteen nimi	Ovh.
76-0088	Bronco moottorisaha/ polttoainekannisterin pidike	99,00
76-0088-1	Bronco moottorisaha/ polttoainekannisterin pidike	131,50



Tavarateline Can-Am Renegade -mönkijään

- Mitat: 87,5 cm x 37 cm
- Yhden tuuman teräsputkesta valmistettu rakenne
- Asennus ei vaadi muutoksia mönkijään

Tuoteno	Tuotteen nimi	Osh.
76-073151	Tavarateline Can-Am Renegade	159,50



ATV



GEN II TUULISUOJAT

Tärinää tehokkaasti vähentävät tuulisuojat. Käsinsuojien alueen läpinäkyvyys takaa esteettömän näkymän. Voidaan irroittaa muutamissa sekunneissa. Kiinnityssarja saatavilla lähes kaikkiin mönkijöihin.



Merkki	vm.	Tuulisuoja Gen II musta	Hinta	Tuulisuoja Gen II kirkas	Hinta	Kiinnityssarja	Hinta
AIE / CF MOTORS							
MOOSE 500A (2 up-seat)	2006-08	76-479800	284,30	76-579800	247,50	76-479722	36,80
Trail Tracker 500 EFI EX (2-up)	2010-12	76-479800	284,30	76-579800	247,50	76-479722	36,80
Trail Tracker 600 EFI	2010-12	76-479800	284,30	76-579800	247,50	76-479722	36,80
Trail Tracker 600 EFI EX (2-up)	2010-12	76-479800	284,30	76-579800	247,50	76-479722	36,80
ARCTIC CAT							
1000 Kaikki mallit	2008-14	76-479800	284,30	76-579800	247,50	76-479008	36,80
700 Kaikki mallit	2006-13	76-479800	284,30	76-579800	247,50	76-479008	36,80
650 Kaikki mallit	2004-11	76-479800	284,30	76-579800	247,50	76-479008	36,80
550 Kaikki mallit	2009-14	76-479800	284,30	76-579800	247,50	76-479008	36,80
500 Kaikki mallit	2005-14	76-479800	284,30	76-579800	247,50	76-479008	36,80
450 Kaikki mallit	2010-14	76-479800	284,30	76-579800	247,50	76-479008	36,80
400i 4x4 / LE / Auto	2006-12	76-479800	284,30	76-579800	247,50	76-479008	36,80
400 Man./400 Auto 4x4	2005	76-479800	284,30	76-579800	247,50	76-479008	36,80
CAN-AM							
Outlander MAX 800R EFI XT-P / XT	2011-13	76-479800	284,30	76-579800	247,50	76-479104	38,50
Outlander 800R EFI XT-P / MAX	2010-14	76-479800	284,30	76-579800	247,50	76-479104	38,50
Outlander 650 EFI XT-P / MAX	2010-14	76-479800	284,30	76-579800	247,50	76-479104	38,50
Outlander 650/800 H.O. EFI / MAX	2009	76-479800	284,30	76-579800	247,50	76-479104	38,50
Outlander 650/800 H.O. EFI / MAX	2006-08	76-479800	284,30	76-579800	247,50	76-479104	38,50
Outlander MAX 500 XT EFI	2011	76-479800	284,30	76-579800	247,50	76-479104	38,50
Outlander 500 H.O. EFI / MAX	2009-14	76-479800	284,30	76-579800	247,50	76-479104	38,50
Outlander 500 H.O. EFI / MAX	2007-08	76-479800	284,30	76-579800	247,50	76-479104	38,50
Outlander 400 H.O. / MAX	2009	76-479800	284,30	76-579800	247,50	76-479104	38,50
Outlander 400 H.O. / MAX	2006-08	76-479800	284,30	76-579800	247,50	76-479104	38,50
HONDA							
Rincon 680	2011-14	76-479800	284,30	76-579800	247,50	76-479235	36,80
Rincon TRX680FG /GPScape	2006-10	76-479800	284,30	76-579800	247,50	76-479235	36,80
Rubicon 500 (ALL)	2009-14	76-479803	284,30	76-579803	259,00	76-479216	36,80
Rubicon 500 (ALL)	2005-07	76-479803	284,30	76-579803	259,00	76-479216	36,80
TRX 500 Foreman (FM)	2010-13	76-479803	284,30	76-579803	259,00	76-479216	36,80
Foreman TRX500FPE Power steering	2007-08	76-479803	284,30	76-579803	259,00	76-479216	36,80
Foreman TRX500FG	2007-08	76-479803	284,30	76-579803	259,00	76-479216	36,80
Foreman 500 TM/FM/FE	2005-08	76-479803	284,30	76-579803	259,00	76-479216	36,80
TRX 420 Independant axle	2009-14	76-479800	284,30	76-579800	247,50	76-479235	36,80
TRX 420 FPE Rigid axle	2009/2011-2014	76-479800	284,30	76-579800	247,50	76-479235	36,80
TRX420FE/FM	2007-08	76-479800	284,30	76-579800	247,50	76-479235	36,80
KAWASAKI							
KVF 750i 4x4 Brute Force	2005-14	76-479800	284,30	76-579800	247,50	76-479315	64,00
KVF 650i 4x4 Brute Force	2007-14	76-479800	284,30	76-579800	247,50	76-479315	64,00
POLARIS							
Sportsman XP850 Touring	2012-14	76-479801	284,30	76-579801	259,00	76-479417	36,80
Sportsman XP550 Touring	2010-14	76-479801	284,30	76-579801	259,00	76-479417	36,80
XP850/550	2009-11	76-479801	284,30	76-579801	259,00	76-479417	36,80
850 X2 EFI	2011	76-479801	284,30	76-579801	259,00	76-479417	36,80
800 X2 EFI	2007	76-479801	284,30	76-579801	259,00	76-479410	36,80
Touring EFI 800	2008-09	76-479801	284,30	76-579801	259,00	76-479410	36,80
Touring EFI 500	2008-09	76-479801	284,30	76-579801	259,00	76-479410	36,80
Sportsman 800 EFI	2009-14	76-479801	284,30	76-579801	259,00	76-479410	36,80
Sportsman 800 EFI	2007	76-479801	284,30	76-579801	259,00	76-479410	36,80
Sportsman Twin 800	2005-06	76-479801	284,30	76-579801	259,00	76-479410	36,80
Sportsman 700 EFI	2005-07	76-479801	284,30	76-579801	259,00	76-479410	36,80
Sportsman Twin 600	2005	76-479801	284,30	76-579801	259,00	76-479410	36,80
550 X2	2010-14	76-479801	284,30	76-579801	259,00	76-479417	36,80

-  Vanteet ja renkaat
-  Talvituotteet
-  Vinsit
-  Laukut ja tuulisuojat
-  Sähköosat
-  Jousitus ja voimansiirto
-  Pakoputket ja suutinsarjat
-  Ohjaus
-  Rungon osat ja peitteet
-  Jarrupalat ja rattaat
-  Moottori
-  Variaattorin osat
-  Maatalous-tarvikkeet
-  Kärryt ja reet



GEN II TUULISUOJAT JATKUU



Merkki	vm.	Tuulisuoja Gen II musta	Hinta	Tuulisuoja Gen II kirkas	Hinta	Kiinnitys-sarja	Hinta
500 X2	2006	76-479801	284,30	76-579801	259,00	76-479410	36,80
Sportsman 500 6x6	2006-07	76-479801	284,30	76-579801	259,00	76-479410	36,80
Sportsman 500 EFI	2009	76-479801	284,30	76-579801	259,00	76-479410	36,80
Sportsman 500 EFI	2006-07	76-479801	284,30	76-579801	259,00	76-479410	36,80
Sportsman 500 H.O	2011-14	76-479801	284,30	76-579801	259,00	76-479419	36,80
Sportsman 500 HO	2005-2010	76-479801	284,30	76-579801	259,00	76-479410	36,80
Sportsman 450	2006-07	76-479801	284,30	76-579801	259,00	76-479410	36,80
Sportsman 400 Single	2005-14	76-479801	284,30	76-579801	259,00	76-479410	36,80
SUZUKI							
King Quad 750i 4X4 Power Steering	2009-14	76-479802	284,30	76-579802	259,00	76-479605	36,80
King Quad 750X (No Power Steering)	2011-14	76-479802	284,30	76-579802	259,00	76-479628	36,80
King Quad 750i 4X4 (W/O Power steering)	2008-09	76-479802	284,30	76-579802	259,00	76-479628	36,80
King Quad 700 4X4	2005-07	76-479802	284,30	76-579802	259,00	76-479605	36,80
King Quad 500 Axi Power Steering	2009-14	76-479800	284,30	76-579800	247,50	76-479623	36,80
King Quad 450i 4X4	2009-10	76-479800	284,30	76-579800	247,50	76-479623	36,80
King Quad 450i 4X4	2007-08	76-479800	284,30	76-579800	247,50	76-479623	36,80
King Quad 400 4x4	2010-14	76-479800	284,30	76-579800	247,50	76-479623	36,80
King Quad 400 4x4	2009	76-479800	284,30	76-579800	247,50	76-479623	36,80
YAMAHA							
Grizzly 700 KAIKKI	2007-14	76-479800	284,30	76-579800	247,50	76-479722	36,80
Grizzly 660	2002-08	76-479800	284,30	76-579800	247,50	76-479722	36,80
Grizzly 550	2009-13	76-479800	284,30	76-579800	247,50	76-479722	36,80
Kodiak 450	2009-14	76-479800	284,30	76-579800	247,50	76-479722	36,80
Kodiak 400/450 4x4	2008	76-479800	284,30	76-579800	247,50	76-479722	36,80
Kodiak 350	2010-11	76-479800	284,30	76-579800	247,50	76-479722	36,80
Kodiak 350/400/450/ Ultra 4x4	2007	76-479800	284,30	76-579800	247,50	76-479722	36,80
Bruin 350 4x4	2004-11	76-479800	284,30	76-579800	247,50	76-479722	36,80
Big Bear 400 4X4 Ind.	2010	76-479800	284,30	76-579800	247,50	76-479722	36,80
Big Bear 400 4X4	2007	76-479800	284,30	76-579800	247,50	76-479722	36,80
Big Bear 250	2007	76-479800	284,30	76-579800	247,50	76-479722	36,80



Vanteet ja renkaat



Talvituotteet



Vinssit



Laukut ja tuulisuojat

Sähköosat



Jousitus ja voimansiirto



Pakoputket ja suutinsarjat



Ohjaus



Rungon osat ja peitteet



Jarrupalat ja rattaat



Moottori



Variaattorin osat



Maatalous-tarvikkeet



Kärryt ja reet

YLEISMALLISET TUULISUOJAT

Cobra Pro Tek -tuulisuoja

Varustettu pikakiinnityksellä. HUOM!
Tämä malli ei sovi Can-Am -mönkijöihin.

Tuotenro	Malli	Ovh.
76-124	Yleismalli (leikattu paikka etulyhdylle)	194,00
76-125	Yleismalli	194,00



Tuulisuoja 46x91cm

Sis. Täydellinen kiinnityssarja

Tuotenro	Tuote	Ovh.
76-120	Tuulisuoja	100,70
76-120-2	Kiinn. sarjan varaosat	38,70



Tuulisuoja 56x86cm

Sis. Täydellinen kiinnityssarja

Tuotenro	Tuote	Ovh.
76-120-1	Tuulisuoja	93,50
76-120-3	Kiinn.sarjan varaosat	38,70



BRONCO Tuulisuoja 52x90cm

uutuus!

Tuotenro	Tuote	Ovh.
76-126	Yleismalli	89,00



BRONCO
ATV COMPONENTS

ATV

AKUT: SOPIVUUSTAULUKOT

Ultrakevyet Lithium-ioni -akut täydentävät nyt Duellin akkualikoimaa. Aliant on italialainen valmistaja, joka on erikoistunut uusimpaan ja tehokkaimpaan LiFePO4 tekniikkaan.



AEON	Vm.	Tyyppi	Yuasa	Motobatt	Kage	Bronco	Aliant X	Aliant YLP
50 Cobra/CX Sport	Kaikki	YTX4L-BS	14-203	14-502	14-3203	14-203-2	14-401	14-415
90 Cobra/CX Sport	Kaikki	YTX4L-BS	14-203	14-502	14-3203	14-203-2	14-401	14-415
100 Cobra/CX Sport	Kaikki	YTX4L-BS	14-203	14-502	14-3203	14-203-2	14-401	14-415
ARCTIC CAT	Vm.	Tyyppi	Yuasa	Motobatt	Kage	Bronco	Aliant X	Aliant YLP
DVX 50	06-10	YTX5L-BS	14-201	14-507	14-3201	14-201-2	14-401	14-415
90 Kaikki Mallit	-06	YTX4L-BS	14-203	14-502	14-3203	14-203-2	14-401	14-415
DVX 90	06-13	YTX5L-BS	14-201	14-507	14-3201	14-201-2	14-401	14-415
150	-13	YTX9-BS	14-202	14-508	14-3202	14-202-2	14-404	14-416
250 Kaikki Mallit	-10	YTX12-BS	14-205	14-514	14-3205	14-205-2	14-405	14-418
300 Kaikki Mallit	Kaikki	YB14L-A2	14-126	14-517	14-3282	14-126-2	14-403	14-419
300 Kaikki Mallit (tehok.vaihtoehto)	Kaikki	YTX14AH-BS	14-218	14-517	14-3218	14-218-2	14-403	14-419
300 DVX	09-14	YTX12-BS	14-205	14-514	14-3205	14-205-2	14-405	14-418
366	08-12	YB14-A2	14-125	14-517	14-3218	14-125-2	14-403	14-419
366 (tehok.vaihtoehto)	08-12	YTX14AH-BS	14-218	14-517	14-3218	14-218-2	14-403	14-419
400 DVX	Kaikki	YTX9-BS	14-202	14-508	14-3202	14-202-2	14-404	14-416
400 Kaikki Mallit	Kaikki	YB14-A2	14-125	14-517	14-3218	14-125-2	14-403	14-419
400 Kaikki Mallit (tehok.vaihtoehto)	Kaikki	YTX14AH-BS	14-218	14-517	14-3218	14-218-2	14-403	14-419
400 TRV	-10	YB14-A2	14-125	14-517	14-3218	14-125-2	14-403	14-419
500 Kaikki Mallit	Kaikki	YB14-A2	14-125	14-517	14-3218	14-125-2	14-403	14-419
550 H1, TRV	10-14	YTX20H-BS	14-283	14-525	14-3209		14-406	14-420
650 4X4 Automatic	04-06	YB14-A2	14-125	14-517	14-3218	14-125-2	14-403	14-419
650 4X4 Automatic (tehok.vaihtoehto)	04-06	YTX14AH-BS	14-218	14-517	14-3218	14-218-2	14-403	14-419
650 H1, TBX	05-12	YB14-A2	14-125	14-517	14-3218	14-125-2	14-403	14-419
650 Prowler	06-09	YTX24HL-BS	14-222	14-527	14-3222	14-222-2	14-406	14-421
700 H1	-11	YTX20H-BS	14-283	14-525	14-3209		14-406	14-420
700 Prowler	10-13	YB30L-B	14-160	14-528	14-3160	14-160-2		14-421
700 TRV	09-14	YB14-A2	14-125	14-517	14-3218	14-125-2	14-403	14-419
700 i	13-14	YTX20H-BS	14-283	14-525	14-3209		14-406	14-420
1000 Prowler	-14	YIX30L-BS	14-279	14-528	14-3279	14-279-2		14-421
1000 Thundercat	-10	YTX20H-BS	14-283	14-525	14-3209		14-406	14-420
1000 Mudpro 1000H2	10-14	YTX20H-BS	14-283	14-525	14-3209		14-406	14-420
1000 TRV	10-14	YTX20H-BS	14-283	14-525	14-3209		14-406	14-420
1000 I GT	10-14	YTX20H-BS	14-283	14-525	14-3209		14-406	14-420
CAN-AM / BOMBARDIER	Vm.	Tyyppi	Yuasa	Motobatt	Kage	Bronco	Aliant X	Aliant YLP
DS 50,	02-06	YTX4L-BS	14-203	14-502	14-3203	14-203-2	14-401	14-415
Quest 50	02-06	YTX4L-BS	14-203	14-502	14-3203	14-203-2	14-401	14-415
DS 70	-13	YTX4L-BS	14-203	14-502	14-3203	14-203-2	14-401	14-415
DS, Quest 90	02-13	YTX4L-BS	14-203	14-502	14-3203	14-203-2	14-401	14-415
Rally 200	02-06	YB14A-A2	14-150	14-517	14-3150	14-150-2	14-403	14-419
DS 250	06-13	YTX12-BS	14-205	14-514	14-3205	14-205-2	14-405	14-418
Outlander 330	04-05	YTX15L-BS	14-277	14-514			14-406	14-419
Outlander 400	03-04	YTX15L-BS	14-277	14-514			14-406	14-419
Outlander 400 XT,MAX	04-13	YTX20L-BS	14-208	14-525	14-3208	14-208-2	14-406	14-420
DS 450	-13	YT7B-BS	14-276	14-505	14-3276		14-404	14-416
Outlander 500, Efi	-13	YTX20L-BS	14-208	14-525	14-3208	14-208-2	14-406	14-420
Renegade 500 Efi	-13	YTX20L-BS	14-208	14-525	14-3208	14-208-2	14-406	14-420
Traxter 500	99-05	YB16CL-B	14-253	14-525			14-406	14-419
Quest 500	02-05	YB16CL-B	14-253	14-525			14-406	14-419
DS 650	00-06	YTX15L-BS	14-277	14-514			14-406	14-419
Quest 650	02-05	YB16CL-B	14-253	14-525			14-406	14-419
Outlander 650 Efi	-13	YTX20L-BS	14-208	14-525	14-3208	14-208-2	14-406	14-420
Outlander 800 Efi	06-13	YTX20L-BS	14-208	14-525	14-3208	14-208-2	14-406	14-420
Renegade 800 Efi	07-13	YTX20L-BS	14-208	14-525	14-3208	14-208-2	14-406	14-420
Commander 800/100	11-13	YTX20L-BS*		14-525			14-406	14-420
Outlander 1000	12-13	YTX20L-BS*		14-525			14-406	14-420

*F/A voi käyttää vain suljettua akkutyyppeä



Vanteet ja renkaat



Talvituetteet



Vinsit



Laukut ja tuulisuojat



Sähköosat



Jousitus ja voimansiirto



Pakoputket ja suutinsarjat



Ohjaus



Rungon osat ja peitteet



Jarrupalat ja rattaat



Moottori



Variaattorin osat



Maatalous-tarvikkeet



Kärryt ja reet

ATV





AKUT: SOPIVUUSTAULUKOT JATKUU



CANNONDALE	Vm.	Tyyppi	Yuasa	Motobatt	Kage	Bronco	Aliant X	Aliant YLP
400 FX	01	YTX9-BS	14-202	14-508	14-3202	14-202-2	14-404	14-416
Blaze,Cannibal,Moto	02-03	YTX9-BS	14-202	14-508	14-3202	14-202-2	14-404	14-416

DDR	Vm.	Tyyppi	Yuasa	Motobatt	Kage	Bronco	Aliant X	Aliant YLP
Kaikki mallit		YTX4L-BS	14-203	14-502	14-3203	14-203-2	14-401	14-415

ETON	Vm.	Tyyppi	Yuasa	Motobatt	Kage	Bronco	Aliant X	Aliant YLP
50 AXL,TXL,NXL,RXL	99-03	YTX4L-BS	14-203	14-502	14-3203	14-203-2	14-401	14-415
50 KAIKKI	04-05	YTX5L-BS	14-201	14-507	14-3201	14-201-2	14-401	14-415
90 AXL,TXL,NXL,RXL,DXL	00-03	YTX4L-BS	14-203	14-502	14-3203	14-203-2	14-401	14-415
90 KAIKKI	04-13	YTX5L-BS	14-201	14-507	14-3201	14-201-2	14-401	14-415
YXL 150 Yukon	00-03	YTX9-BS	14-202	14-508	14-3202	14-202-2	14-404	14-416

HONDA	Vm.	Tyyppi	Yuasa	Motobatt	Kage	Bronco	Aliant X	Aliant YLP
TRX 90	06-14	YTX5L-BS	14-201	14-507	14-3201	14-201-2	14-401	14-415
ATC 125M	84-85	YB9A-A	14-147	14-509			14-402	14-417
ATC 125M	86-87	YTX12-BS	14-205	14-514	14-3205	14-205-2	14-405	14-418
TRX 125	85-86	YB9A-A	14-147	14-509			14-402	14-417
TRX 125	87-88	YTX9-BS	14-202	14-508	14-3202	14-202-2	14-404	14-416
ATC 200	82-85	YB14A-A2	14-150	14-517	14-3150	14-150-2	14-403	14-419
TRX 200 Fourtrax	84	YB14A-A2	14-150	14-517	14-3150	14-150-2	14-403	14-419
TRX 200 SX Fourtrax	86-88	YTX12-BS	14-205	14-514	14-3205	14-205-2	14-405	14-418
TRX 200 Fourtrax	90-97	YTX12-BS	14-205	14-514	14-3205	14-205-2	14-405	14-418
ATC 250	85-87	YTX12-BS	14-205	14-514	14-3205	14-205-2	14-405	14-418
TRX 250 Sportrax	01-13	YTX9-BS	14-202	14-508	14-3202	14-202-2	14-404	14-416
TRX 250 Fourtrax	85-87	YTX12-BS	14-205	14-514	14-3205	14-205-2	14-405	14-418
TRX 250 Fourtrax Recon	97-13	YTX12-BS	14-205	14-514	14-3205	14-205-2	14-405	14-418
TRX 300 Fourtrax	88-00	YTX14-BS	14-206	14-518	14-3206	14-206-2	14-405	14-419
TRX 300EX Sportrax	93-12	YTX9-BS	14-202	14-508	14-3202	14-202-2	14-404	14-416
TRX 300FW Fourtrax	88-00	YTX14-BS	14-206	14-518	14-3206	14-206-2	14-405	14-419
FL 350R Odyssey	85	YTX12-BS	14-205	14-514	14-3205	14-205-2	14-405	14-418
TRX 350 Fourtrax	86-89	YTX14-BS	14-206	14-518	14-3206	14-206-2	14-405	14-419
TRX 350 Rancher	00-06	YTX14-BS	14-206	14-518	14-3206	14-206-2	14-405	14-419
FL 400R	89-90	YTX14-BS	14-206	14-518	14-3206	14-206-2	14-405	14-419
TRX 400EX,Fourtrax,Sportrax	99-13	YTX9-BS	14-202	14-508	14-3202	14-202-2	14-404	14-416
TRX 400 Rancher	04-07	YTX14-BS	14-206	14-518	14-3206	14-206-2	14-405	14-419
TRX 400 Foreman	95-03	YTX14-BS	14-206	14-518	14-3206	14-206-2	14-405	14-419
TRX 420 Rancher	-13	YTX14-BS	14-206	14-518	14-3206	14-206-2	14-405	14-419
TRX 450 Fourtrax, Foreman	98-04	YTX14-BS	14-206	14-518	14-3206	14-206-2	14-405	14-419
TRX 450R	06-13	YTZ75	14-236	14-507	14-3236	14-236-2	14-402	14-416
TRX 500 FA Fourtrax Rubicon	01-12	YTX14-BS	14-206	14-518	14-3206	14-206-2	14-405	14-419
TRX 500 FE,FM,TM, Foreman	11-12	YTX14-BS	14-206	14-518	14-3206	14-206-2	14-405	14-419
TRX 650 STD.	03-05	YTX14-BS	14-206	14-518	14-3206	14-206-2	14-405	14-419
TRX 650	03-05	YTX20L-BS	14-208	14-525	14-3208	14-208-2	14-406	14-420
TRX 680 Rincon	06-13	YTX20L-BS	14-208	14-525	14-3208	14-208-2	14-406	14-420
TRX 700 XX	08-13	YTX9-BS	14-202	14-508	14-3202	14-202-2	14-404	14-416

HYOSUNG	Vm.	Tyyppi	Yuasa	Motobatt	Kage	Bronco	Aliant X	Aliant YLP
TE 450S	-13	YTX9-BS	14-202	14-508	14-3202	14-202-2	14-404	14-416

KASEA	Vm.	Tyyppi	Yuasa	Motobatt	Kage	Bronco	Aliant X	Aliant YLP
90-250 Useimmat Mallit		YTX7A-BS	14-255	14-511	14-3255	14-255-2	14-404	14-416

KAWASAKI	Vm.	Tyyppi	Yuasa	Motobatt	Kage	Bronco	Aliant X	Aliant YLP
KFX 50	07-13	YTX5L-BS	14-201	14-507	14-3201	14-201-2	14-401	14-415
KSF 80 (KFX)	03-05	YTX5L-BS	14-201	14-507	14-3201	14-201-2	14-401	14-415
KFX 90	07-13	YTX5L-BS	14-201	14-507	14-3201	14-201-2	14-401	14-415
KLF 185 Bayou	85-88	YB10L-B	14-140	14-512			14-403	14-418
KLT 200 A,C	81-84	YB10L-B	14-140	14-512			14-403	14-418
KLT 200 B	83	YB12A-A	14-123	14-513			14-403	14-418
KLF 220 Bayou	92-02	YB14A-A2	14-150	14-517	14-3150	14-150-2	14-403	14-419
KLF 250 Bayou	03-12	YB14A-A2	14-150	14-517	14-3150	14-150-2	14-403	14-419
KLT 250 (A)	82-83	YB12A-A	14-123	14-513		14-123-2	14-403	14-418
KLT 250 Prairie (C)	84-85	YB10L-B	14-140	14-512			14-403	14-418
KLT 250 Prairie (C)	83	YB12A-A	14-123	14-513		14-123-2	14-403	14-418
KEF 300 Lakota,Sport	95-03	YB14A-A2	14-150	14-517	14-3150	14-150-2	14-403	14-419
KLF 300 Bayou	86-87	YB16CL-B	14-253	14-525			14-406	14-419
KLF 300 Bayou (B)	88-04	YB14A-A2	14-150	14-517	14-3150	14-150-2	14-403	14-419
KLF 300 Bayou (B) (CN)	92-99	YB16CL-B	14-253	14-525			14-406	14-419
KLF 300 Bayou (C)	89-04	YB14A-A2	14-150	14-517	14-3150	14-150-2	14-403	14-419

ATV

AKUT: SOPIVUUSTAULUKOT JATKUU



Vanteet ja renkaat



Talvituotteet



Vinsit



Laukut ja tuulisuojat



Sähköosat



Jousitus ja voimansiirto



Pakoputket ja suutinsarjat



Ohjaus



Rungon osat ja peitteet



Jarrupalat ja rattaat



Moottori



Variaattorin osat



Maatalous-tarvikkeet



Kärryt ja reet

KAWASAKI	Vm.	Tyyppi	Yuasa	Motobatt	Kage	Bronco	Aliant X	Aliant YLP
KLF 300 Bayou (C)	92-05	YB16CL-B	14-253	14-525			14-406	14-419
KVF 300 Brute Force	13	YTX12-BS	14-205	14-514	14-3205	14-205-2	14-405	14-418
KVF 300 Prairie	99-02	YB14A-A2	14-150	14-517	14-3150	14-150-2	14-403	14-419
KVF 300 Prairie (CN)	99-02	YB16CL-B	14-253	14-525			14-406	14-419
KVF 360	03-13	YB14A-A2	14-150	14-517	14-3150	14-150-2	14-403	14-419
KAF 400, Mule 600, 610	05-12	YTX14AH-BS	14-218	14-517	14-3218	14-218-2	14-403	14-419
KLF 400 Bayou	93-00	YB16CL-B	14-253	14-525			14-406	14-419
KSF,KFX 400	03-06	YTX9-BS	14-202	14-508	14-3202	14-202-2	14-404	14-416
KVF 400 Prairie (A)	97-00	YB14A-A2	14-150	14-517	14-3150	14-150-2	14-403	14-419
KVF 400 Prairie (A)	97-00	YB16CL-B	14-253	14-525			14-406	14-419
KVF 400 Prairie (B)	98-00	YB14A-A2	14-150	14-517	14-3150	14-150-2	14-403	14-419
KVF 400 Prairie (B)	98-00	YB16CL-B	14-253	14-525			14-406	14-419
KVF 400 Prairie (C)	99-02	YB14A-A2	14-150	14-517	14-3150	14-150-2	14-403	14-419
KVF 400 Prairie (C)	99-02	YTX14-BS	14-206	14-518	14-3206	14-206-2	14-405	14-419
KVF 400 Prairie (D)	99-02	YB14A-A2	14-150	14-517	14-3150	14-150-2	14-403	14-419
KVF 400 Prairie (D)	99-01	YTX14-BS	14-206	14-518	14-3206	14-206-2	14-405	14-419
KFX 450R	08-13	YTX7L-BS	14-207	14-506	14-3207	14-207-2	14-404	14-416
KAF620F, Mule 4010	-13	YTX20L-BS	14-208	14-525	14-3208	14-208-2	14-406	14-420
KVF 650 Brute Force	02-13	YTX14-BS	14-206	14-518	14-3206	14-206-2	14-405	14-419
KFX 700 V-force	03-10	YTX14-BS	14-206	14-518	14-3206	14-206-2	14-405	14-419
KVF 700-A,B,D	04-06	YTX14-BS	14-206	14-518	14-3206	14-206-2	14-405	14-419
KVF 750 Brute Force	05-13	YTX14-BS	14-206	14-518	14-3206	14-206-2	14-405	14-419

KTM	Vm.	Tyyppi	Yuasa	Motobatt	Kage	Bronco	Aliant X	Aliant YLP
450 SX	08-12	YTX5L-BS	14-201	14-507	14-3201	14-201-2	14-401	14-415
450 XC	08-12	YTX5L-BS	14-201	14-507	14-3201	14-201-2	14-401	14-415
505 SX	08-13	YTX5L-BS	14-201	14-507	14-3201	14-201-2	14-401	14-415
525 XC	10-13	YTX5L-BS	14-201	14-507	14-3201	14-201-2	14-401	14-415

KYMC0	Vm.	Tyyppi	Yuasa	Motobatt	Kage	Bronco	Aliant X	Aliant YLP
50 Mongoose	Kaikki	YTX5L-BS	14-201	14-507	14-3201	14-201-2	14-401	14-415
50 MXU	Kaikki	YTX9-BS	14-202	14-508	14-3202	14-202-2	14-404	14-416
50 MAXXER	Kaikki	YTX5L-BS	14-201	14-507	14-3201	14-201-2	14-401	14-415
90 Mongoose / MAXXER	Kaikki	YTX5L-BS	14-201	14-507	14-3201	14-201-2	14-401	14-415
150 MXER	11-	YTX9-BS	14-202	14-508	14-3202	14-202-2	14-404	14-416
150 MXU	Kaikki	YTX9-BS	14-202	14-508	14-3202	14-202-2	14-404	14-416
250 Mongoose, MXU	Kaikki	YTX12-BS	14-205	14-514	14-3205	14-205-2	14-405	14-418
300 Mongoose, MXU	Kaikki	YTX12-BS	14-205	14-514	14-3205	14-205-2	14-405	14-418
400 MXU	11-	YB14-A2	14-125	14-517	14-3218	14-125-2	14-403	14-419
450 MXU / MAXXER	-13	YTX20L-BS	14-208	14-525	14-3208	14-208-2	14-406	14-420
500 MXU	-13	YTX20L-BS	14-208	14-525	14-3208	14-208-2	14-406	14-420
700 MXU	-13	YTX20L-BS	14-208	14-525	14-3208	14-208-2	14-406	14-420

PANDA	Vm.	Tyyppi	Yuasa	Motobatt	Kage	Bronco	Aliant X	Aliant YLP
KD 50	Kaikki	YB7-A	14-278	14-509			14-402	14-416
KD 80	Kaikki	YB7-A	14-278	14-509			14-402	14-416
KD 125	Kaikki	YB7-A	14-278	14-509			14-402	14-416

POLARIS	Vm.	Tyyppi	Yuasa	Motobatt	Kage	Bronco	Aliant X	Aliant YLP
50 Scrambler	01-02	YTX4L-BS	14-203	14-502	14-3203	14-203-2	14-401	14-415
50 Scrambler	03	YTX5L-BS	14-201	14-507	14-3201	14-201-2	14-401	14-415
50 Predator, Outlaw	04-13	YTX5L-BS	14-201	14-507	14-3201	14-201-2	14-401	14-415
90 Predator,Sportsman,Outlaw	03-13	YTX5L-BS	14-201	14-507	14-3201	14-201-2	14-401	14-415
90 Scrambler,Sportsman	01-02	YTX4L-BS	14-203	14-502	14-3203	14-203-2	14-401	14-415
170 Ranger RZR	-14	YTX12-BS	14-205	14-514	14-3205	14-205-2	14-405	14-418
200 Phoenix, Sawtooth	05-13	YTX12-BS	14-205	14-514	14-3205	14-205-2	14-405	14-418
250 Kaikki Mallit	85-08	YB14A-A2	14-150	14-517	14-3150	14-150-2	14-403	14-419
300 Hawkeye, Sportsman	06-10	YB14-B2	14-141	14-517			14-403	14-419
325 Kaikki Mallit	87-02	YB14A-A2	14-150	14-517	14-3150	14-150-2	14-403	14-419
330 Magnum,Trail Boss	03-13	YTX14AH-BS	14-218	14-517	14-3218	14-218-2	14-403	14-419
Sportsman 335	98-01	YB14A-A2	14-150	14-517	14-3150	14-150-2	14-403	14-419
400 Kaikki Mallit	94-14	YB14A-A2	14-150	14-517	14-3150	14-150-2	14-403	14-419
400 Ranger	11-14	YTX14AH-BS	14-218	14-517	14-3218	14-218-2	14-403	14-419
400 Sportsman	11-12	YTX14AH-BS	14-218	14-517	14-3218	14-218-2	14-403	14-419
425 Kaikki Mallit	95-02	YB14A-A2	14-150	14-517	14-3150	14-150-2	14-403	14-419
450 Diesel 1.AKKU	99-03	YB30L-B	14-160	14-528	14-3160	14-160-2	14-421	14-421
2.AKKU		YB14A-A2	14-150	14-517	14-3150	14-150-2	14-403	14-419
450 Outlaw	07-10	YTX9-BS	14-202	14-508	14-3202	14-202-2	14-404	14-416
500 Kaikki Mallit (ei Predator)	99-12	YB14A-A2	14-150	14-517	14-3150	14-150-2	14-403	14-419
500 Predator, Outlaw	03-06	YTX9-BS	14-202	14-508	14-3202	14-202-2	14-404	14-416

ATV





AKUT: SOPIVUUSTAULUKOT JATKUU



POLARIS	Vm.	Tyyppi	Yuasa	Motobatt	Kage	Bronco	Aliant X	Aliant YLP
500 Ranger 500,EFI	04-10	YIX30L-BS	14-279	14-528	14-3279	14-279-2		14-421
500 Sportsman	-11	YIX30L-BS	14-279	14-528	14-3279	14-279-2		14-421
500 Sportsman HO	96-13	YTX14AH-BS	14-218	14-517	14-3218	14-218-2	14-403	14-419
525 Outlaw	08-12	YTX9-BS	14-202	14-508	14-3202	14-202-2	14-404	14-416
550 Sportsman	09	YTX20HL-BS	14-280	14-525	14-3208	14-280-2	14-406	14-420
550 Sportsman EPS, XP	10-14	YTX14AH*		14-517			14-403	14-419
570 Sportsman	14	YB14A-A2	14-150	14-517	14-3150	14-150-2	14-403	14-419
600 Sportsman	04-05	YB30L-B	14-160	14-528	14-3160	14-160-2		14-421
700 Ranger EFI	07-09	YB30L-B	14-160	14-528	14-3160	14-160-2		14-421
700 Sportsman	02-06	YB30L-B	14-160	14-528	14-3160	14-160-2		14-421
700 Sportsman	07-10	YIX30L-BS	14-279	14-528	14-3279	14-279-2		14-421
800 Ranger RZR EFI	08-13	YTX20HL-BS	14-280	14-525	14-3208	14-280-2	14-406	14-420
800 Sportsman,EFI	05-13	YIX30L-BS	14-279	14-528	14-3279	14-279-2		14-421
800 Sportsman	14	YTX20HL*		14-525			14-406	14-420
850 Scrambler	14	YTX20HL*		14-525			14-406	14-420
850 Sportsman XP	09-14	YIX30L*		14-528				14-421
900 Ranger RZR	10-14	YTX20HL*		14-525			14-406	14-420
1000 Scrambler	14	YTX20HL*		14-525			14-406	14-420
*F/A voi käyttää vain suljettua akkutyyppeä								

SUZUKI	Vm.	Tyyppi	Yuasa	Motobatt	Kage	Bronco	Aliant X	Aliant YLP
LT-Z50 Quad Sport	06-12	YTX5L-BS	14-201	14-507	14-3201	14-201-2	14-401	14-415
LT 80 Quad Sport	87-06	YTX5L-BS	14-201	14-507	14-3201	14-201-2	14-401	14-415
LT-Z 90	07-12	YTX7A-BS	14-255	14-511	14-3255	14-255-2	14-404	14-416
LT 160E/LT-F160 Quad Runner	89-04	YB9A-A	14-147	14-509			14-402	14-417
LT 230 Quad Runner	88-93	YTX12-BS	14-205	14-514	14-3205	14-205-2	14-405	14-418
LT 4WD Quad Runner	87-99	YB14A-A2	14-150	14-517	14-3150	14-150-2	14-403	14-419
LT 4WD (tehok.vaihtoehto)	87-99	Y50-N18A-A	14-157	14-527			14-406	14-420
LT 250EF	85-86	Y50-N18A-A	14-157	14-527			14-406	14-420
LT-F 250	88-02	YB14A-A2	14-150	14-517	14-3150	14-150-2	14-403	14-419
LT-F 250 (tehok.vaihtoehto)	88-02	Y50-N18A-A	14-157	14-527			14-406	14-420
LT-F 250	02-13	YTX12-BS	14-205	14-514	14-3205	14-205-2	14-405	14-418
LT-Z 250	04-12	YTX12-BS	14-205	14-514	14-3205	14-205-2	14-405	14-418
LT-F4WD King Quad	91-99	YB14A-A2	14-150	14-517	14-3150	14-150-2	14-403	14-419
LT-F4WD (tehok.vaihtoehto)	91-99	Y50-N18A-A	14-157	14-527			14-406	14-420
LT 300 E Quad Runner	87-89	YB14A-A2	14-150	14-517	14-3150	14-150-2	14-403	14-419
LT-F4WD King Quad	99-02	YB14A-A2	14-150	14-517	14-3150	14-150-2	14-403	14-419
LT-F4WD (tehok.vaihtoehto)	99-02	Y50-N18A-A	14-157	14-527			14-406	14-420
LT-A 400 Eiger	02-07	YTX14-BS	14-206	14-518	14-3206	14-206-2	14-405	14-419
LT-F 400 Eiger	02-07	YTX14-BS	14-206	14-518	14-3206	14-206-2	14-405	14-419
LT-A 400 F King Quad	-13	YTX14-BS	14-206	14-518	14-3206	14-206-2	14-405	14-419
LT-Z 400 Quad Sport	03-13	YTX9-BS	14-202	14-508	14-3202	14-202-2	14-404	14-416
LT-A 450X King Quad	07-12	YTX14-BS	14-206	14-518	14-3206	14-206-2	14-405	14-419
LT-F 450 King Quad Xi	09	YTX14-BS	14-206	14-518	14-3206	14-206-2	14-405	14-419
LT-R 450 Quad Racer	06-11	YTX7A-BS	14-255	14-511	14-3255	14-255-2	14-404	14-416
LT-A 500 F Quad Master	00-01	YTX16-BS-1	14-215	14-519	14-3215	14-215-2	14-406	14-419
LT-A 500 F Vinson	02-03	YTX16-BS	14-211	14-519	14-3211	14-211-2	14-406	14-419
LT-A 500 F Vinson	04-07	YTX20CH-BS	14-281	14-519	14-3281	14-281-2	14-406	14-420
LT-A 500 XP King Quad	-13	YTX20CH-BS	14-281	14-519	14-3281	14-281-2	14-406	14-420
LT-F 500 F Quad Runner	98-02	YTX16-BS-1	14-215	14-519	14-3215	14-215-2	14-406	14-419
LT-F 500 F Vinson	03	YTX16-BS	14-211	14-519	14-3211	14-211-2	14-406	14-419
LT-F 500 F Vinson	04-07	YTX20CH-BS	14-281	14-519	14-3281	14-281-2	14-406	14-420
LT 700 Twin Peaks	04-	YTX20CH-BS	14-281	14-519	14-3281	14-281-2	14-406	14-420
LT-A 700X King Quad	05-07	YTX20CH-BS	14-281	14-519	14-3281	14-281-2	14-406	14-420
LT-V 700F Twin Peaks	04-05	YTX14*		14-518			14-405	14-419
LT-A 750X King Quad	07-13	YTX20CH-BS	14-281	14-519	14-3281	14-281-2	14-406	14-420
*F/A voi käyttää vain suljettua akkutyyppeä								

YAMAHA	Vm.	Tyyppi	Yuasa	Motobatt	Kage	Bronco	Aliant X	Aliant YLP
50 YFM Raptor	04-09	12N7-3B	14-053	14-509			14-402	14-416
80 YFM Raptor, Grizzly	85-08	12N7-3B	14-053	14-509			14-402	14-416
80 YFM Bruin	04-06	YB14A-A2	14-150	14-517	14-3150	14-150-2	14-403	14-419
90 Raptor	09-13	YTX5L-BS	14-201	14-507	14-3201	14-201-2	14-401	14-415
100 YFM Champ	87-91	12N7-3B	14-053	14-509			14-402	14-416
125 YFA-1 Breeze	89-04	YB12C-A	14-158	14-513			14-403	14-418
125 YFM S	04-13	YB12C-A	14-158	14-513			14-403	14-418
200 YFM Moto-4	85-89	YB14A-A2	14-150	14-517	14-3150	14-150-2	14-403	14-419
225 YTM Tri-Moto	83-86	YB14A-A2	14-150	14-517	14-3150	14-150-2	14-403	14-419
230 YFU Pro Hauler	89	YB14A-A2	14-150	14-517	14-3150	14-150-2	14-403	14-419
250 YFB Timberwolf	92-00	YB12C-A	14-158	14-513			14-403	14-418



AKUT: SOPIVUUSTAULUKOT JATKUU



YAMAHA	Vm.	Tyyppi	Yuasa	Motobatt	Kage	Bronco	Aliant X	Aliant YLP
250 YFM Bear Tracker	99-04	YB14A-A2	14-150	14-517	14-3150	14-150-2	14-403	14-419
250 YFM Raptor	08-13	YTZ7S	14-236	14-507	14-3236	14-236-2	14-402	14-416
250 YFM Bruin	05-06	YB14A-A2	14-150	14-517	14-3150	14-150-2	14-403	14-419
250 YFM Big Bear	07-10	YB14A-A2	14-150	14-517	14-3150	14-150-2	14-403	14-419
250 YFM Moto-4	89-91	YB14A-A2	14-150	14-517	14-3150	14-150-2	14-403	14-419
300 Grizzly	11-13	YTX12-BS	14-205	14-514	14-3205	14-205-2	14-405	14-418
350 YFM Big Bear	87-99	YB14A-A2	14-150	14-517	14-3150	14-150-2	14-403	14-419
350 YFM Bruin	04-06	YTX14AH-BS	14-218	14-517	14-3218	14-218-2	14-403	14-419
350 YFM Grizzly	07-14	YTX14AH-BS	14-218	14-517	14-3218	14-218-2	14-403	14-419
350 YFM Moto-4	87-95	YB14A-A2	14-150	14-517	14-3150	14-150-2	14-403	14-419
350 YFM Raptor	04-13	YTZ10S	14-233	14-511	14-3233	14-233-2	14-404	14-418
350 YFM Warrior	87-03	YB12C-A	14-158	14-513			14-403	14-418
350 YFM Wolverine	95-05	YB12C-A	14-158	14-513			14-403	14-418
350 YFM Wolverine	06-10	YTX14AH-BS	14-218	14-517	14-3218	14-218-2	14-403	14-419
350 YFP Terra Pro	88	YB14A-A2	14-150	14-517	14-3150	14-150-2	14-403	14-419
400 YFM Grizzly	07-08	YTX14AH-BS	14-218	14-517	14-3218	14-218-2	14-403	14-419
400 YFM Kodiak	93-95	YB14A-A2	14-150	14-517	14-3150	14-150-2	14-403	14-419
400 YFM Kodiak	96-02	YTX20L-BS	14-208	14-525	14-3208	14-208-2	14-406	14-420
400 YFM Kodiak	03-06	YTX14AH-BS	14-218	14-517	14-3218	14-218-2	14-403	14-419
400 YFM Big Bear	00-12	YTX20L-BS	14-208	14-525	14-3208	14-208-2	14-406	14-420
450 YFM Grizzly	07-14	YTX20L-BS	14-208	14-525	14-3208	14-208-2	14-406	14-420
450 YFM Kodiak	03-06	YTX20L-BS	14-208	14-525	14-3208	14-208-2	14-406	14-420
450 YFM Wolverine	06-10	YTX20L-BS	14-208	14-525	14-3208	14-208-2	14-406	14-420
450 YFZ	04-13	YT7B-BS	14-276	14-505	14-3276		14-404	14-416
450 YFZ R	09-14	YTZ7S	14-236	14-507	14-3236	14-236-2	14-402	14-416
550 YFM Grizzly	-14	YTX20L-BS	14-208	14-525	14-3208	14-208-2	14-406	14-420
600 YFM Grizzly	98-01	YTX20L-BS	14-208	14-525	14-3208	14-208-2	14-406	14-420
660 YFM Grizzly	02-08	YTX20L-BS	14-208	14-525	14-3208	14-208-2	14-406	14-420
660 YFM Raptor	01-05	YTX14-BS	14-206	14-518	14-3206	14-206-2	14-405	14-419
700 YFM Raptor	06-14	YT9B-BS	14-250	14-510	14-3250		14-405	14-417
700 YFM Grizzly	07-14	YTX20L-BS	14-208	14-525	14-3208	14-208-2	14-406	14-420

AKKUJEN HINNAT



Tuoteno.	Ovh.	Tuoteno.	Ovh.	Tuoteno.	Ovh.	Tuoteno.	Ovh.	Tuoteno.	Ovh.	Tuoteno.	Ovh.
14-053	37,00	14-203	33,00	14-236	135,00	14-3203	25,00	14-403	280,50	14-507	59,00
14-123	58,00	14-203-2	3,00	14-236-2	60,50	14-3205	59,00	14-404	214,50	14-508	63,00
14-123-2	50,00	14-205	75,00	14-250	112,00	14-3206	63,00	14-405	280,50	14-509	57,00
14-125	58,00	14-205-2	70,50	14-253	118,00	14-3207	39,00	14-406	352,00	14-510	59,00
14-125-2	57,50	14-206	99,00	14-255	64,00	14-3208	85,00	14-415	117,00	14-511	69,00
14-126	65,00	14-206-2	76,50	14-255-2	50,00	14-3209	85,00	14-416	128,00	14-512	69,00
14-126-2	57,50	14-207	64,00	14-276	87,00	14-3211	72,00	14-417	159,00	14-513	79,00
14-140	58,00	14-207-2	46,00	14-277	145,00	14-3215	72,00	14-418	188,00	14-514	77,00
14-141	65,00	14-208	145,00	14-278	45,00	14-3218	72,00	14-419	206,00	14-517	84,00
14-147	49,00	14-208-2	107,50	14-279	270,00	14-3222	129,00	14-420	291,00	14-518	99,00
14-150	69,00	14-211	139,00	14-279-2	121,50	14-3233	49,00	14-421	320,00	14-519	99,00
14-150-2	60,50	14-211-2	81,50	14-280	159,00	14-3236	42,00	14-502	34,00	14-525	115,00
14-157	108,00	14-215	139,00	14-280-2	107,50	14-3250	55,00	14-505	43,00	14-527	129,00
14-158	65,00	14-215-2	91,00	14-281	159,00	14-3255	39,00	14-506	56,00	14-528	175,00
14-160	149,00	14-218	132,00	14-281-2	111,50	14-3276	49,00				
14-160-2	121,50	14-218-2	76,50	14-283	159,00	14-3279	135,00				
14-201	62,00	14-222	173,00	14-3150	65,00	14-3281	99,00				
14-201-2	43,00	14-222-2	105,00	14-3160	115,00	14-3282	72,00				
14-202	65,00	14-233	162,00	14-3201	30,00	14-401	162,50				
14-202-2	60,50	14-233-2	76,50	14-3202	49,00	14-402	214,05				

Akkujen hintoihin saattaa tulla muutoksia dollarin kurssin ja lyijyn maailmanmarkkina-hintojen mahdollisesti muuttuessa. Tarkista hinnat osoitteessa: www.duell.fi

HUOM! Kaikki akkujen hinnat ja mitat löytyvät Yleistekniikka-osiosta.

ATV





SYTYTYSTULPAT



Vanteet ja renkaat



Talvituotteet



Vinssit



Laukut ja tuulisuojat



Sähköosat



Jousitus ja voimansiirto



Pakoputket ja suutinsarjat



Ohjaus



Rungon osat ja peitteet



Jarrupalat ja rattaat



Moottori



Variaattorin osat



Maatalous-tarvikkeet



Kärryt ja reet

ATV

ARCTIC CAT		VAKIO/SUOSITUS			IRIDIUM		
malli	vm	Tyyppi	Tilno.	Hinta	Tyyppi	Tilno.	Hinta
50 2X4 2-T	04-05	BPR7HS	13-6422	6,30	BPR7HIX	13-5944	25,00
50 2X4 4-T	06-	CR7HSA	13-4549	6,50	CR7HIX	13-7544	25,00
90 2x4 2-T.	02-08	BPR7HS	13-6422	6,30	BPR7HIX	13-5944	25,00
90 DVX 4-T	06-12	CR7HSA	13-4549	6,50	CR7HIX	13-7544	25,00
150 4-T	09-12	DR8EA	13-7162	6,00	DR8EIX	13-6681	25,00
250 DVX	06-09	DPR7EA-9	13-5129	5,90	DPR7EIX-9	13-7803	25,00
250 2x4,4x4	99-05	DR7EA	13-7839	6,90			
250 2x4	06-09	DPR7EA-9	13-5129	5,90	DPR7EIX-9	13-7803	25,00
300 4x4	98-05	DR7EA	13-7839	6,90			
300 DVX	09-12	DPR7EA-9	13-5129	5,90	DPR7EIX-9	13-7803	25,00
350 CR	12	CR8E	13-1275	13,20	CR8EIX	13-4218	25,00
366	08	CR7E	13-4578	13,20	CR7EIX	13-7385	25,00
366	09	CR8E	13-1275	13,20	CR8EIX	13-4218	25,00
375	02	CR7E	13-4578	13,20	CR7EIX	13-7385	25,00
400 TBX, i	03-08	CR7E	13-4578	13,20	CR7EIX	13-7385	25,00
400 DVX	04-08	CR7E	13-4578	13,20	CR7EIX	13-7385	25,00
400 TRV 4X4	09-10	CR8E	13-1275	13,20	CR8EIX	13-4218	25,00
425/450 i	12	CR7E	13-4578	13,20	CR7EIX	13-7385	25,00
454 4x4	96-98	CR6E	13-6965	13,60			
500 4x4	99-09	CR6E	13-6965	13,60			
550 H1, TRV, Prowler, i	09-12	CPR8E	13-7411	13,00			
650 V-TWIN	05-06	CR7E	13-4578	13,20	CR7EIX	13-7385	25,00
650 H1	05-08	CR8EB	13-7784	13,50	CR8EIX	13-4218	25,00
650 H1, i	09-12	CPR8E	13-7411	13,00			
650 Prowler	08	CR8EB	13-7784	13,50	CR8EIX	13-4218	25,00
650 Prowler	09	CPR8E	13-7411	13,00			
700 Efi	06-08	CR6E	13-6965	13,60			
700 Efi H1	09-12	CPR8E	13-7411	13,00			
700 Prowler	08	CR8EB	13-7784	13,50	CR8EIX	13-4218	25,00
700 Prowler	09-10	CPR8E	13-7411	13,00			
1000 H2 Thundercat	09-	CPR8E	13-7411	13,00			
1000 Prowler XTZ	09-	CPR8E	13-7411	13,00			

CAN-AM/BOMBARDIER		VAKIO/SUOSITUS			IRIDIUM		
malli	vm	Tyyppi	Tilno.	Hinta	Tyyppi	Tilno.	Hinta
DS 50 2-T	02-06	BPR7HS	13-6422	6,30	BPR7HIX	13-5944	25,00
DS 70 4-T	09-12	CR7HSA	13-4549	6,50	CR7HIX	13-7544	25,00
DS 90 2-T	02	BPR7HS	13-6422	6,30	BPR7HIX	13-5944	25,00
DS 90 4-T	02-	CR7HSA	13-4549	6,50	CR7HIX	13-7544	25,00
Quest 50 2-T	03	BPR7HS	13-6422	6,30	BPR7HIX	13-5944	25,00
Quest 90 4-T	03	CR7HSA	13-4549	6,50	CR7HIX	13-7544	25,00
Rally	03-07	CR8E	13-1275	13,20	CR8EIX	13-4218	25,00
DS 250	06-	CR8E	13-1275	13,20	CR8EIX	13-4218	25,00
Outlander 330	04-05	DCPR8E	13-4339	11,70	DCPR8EIX	13-6546	25,00
Outlander 400	03-07	DCPR8E	13-4339	11,70	DCPR8EIX	13-6546	25,00
Outlander 400 Efi	08-	DCPR8E	13-4339	11,70	DCPR8EIX	13-6546	25,00
DS 450 Efi	08-	DCPR9E	13-2641	11,70	DCPR9EIX	13-2316	25,00
Outlander 500 Efi	07-	DCPR8E	13-4339	11,70	DCPR8EIX	13-6546	25,00
Quest 500	02-04	DCPR8E	13-4339	11,70	DCPR8EIX	13-6546	25,00
Renegade 500	08-	DCPR8E	13-4339	11,70	DCPR8EIX	13-6546	25,00
Traxter	99-05	DR8EA	13-7162	6,00	DR8EIX	13-6681	25,00
DS 650	00-07	DR8EA	13-7162	6,00	DR8EIX	13-6681	25,00
Outlander 650 Efi	06-	DCPR8E	13-4339	11,70	DCPR8EIX	13-6546	25,00
Quest 650	03	DCPR8E	13-4339	11,70	DCPR8EIX	13-6546	25,00
Commander 800	11-	DCPR8E	13-4339	11,70	DCPR8EIX	13-6546	25,00
Outlander 800	06-	DCPR8E	13-4339	11,70	DCPR8EIX	13-6546	25,00
Renegade 800	07-	DCPR8E	13-4339	11,70	DCPR8EIX	13-6546	25,00
Commander 1000	11-	DCPR8E	13-4339	11,70	DCPR8EIX	13-6546	25,00
Maverick 1000	13-	LMAR8C-9	13-93833				
Renegade 1000	12-13	DCPR8E	13-4339	11,70	DCPR8EIX	13-6546	25,00
Outlander 1000	13	DCPR8E	13-4339	11,70	DCPR8EIX	13-6546	25,00

CPI		VAKIO/SUOSITUS			IRIDIUM		
malli	vm	Tyyppi	Tilno.	Hinta	Tyyppi	Tilno.	Hinta
50 ATV/XT50R		BR7HS	13-4122	6,20	BR7HIX	13-7067	25,00
100 ATV		BR7HS	13-4122	6,20	BR7HIX	13-7067	25,00
200 ATV		BR7HS	13-4122	6,20	BR7HIX	13-7067	25,00
XS 250	06-	CR7HSA	13-4549	6,50	CR7HIX	13-7544	25,00

SYTYTYSTULPAT JATKUU



DERBI		VAKIO/SUOSITUS			IRIDIUM		
malli	vm	Tyyppi	Tilnro.	Hinta	Tyyppi	Tilnro.	Hinta
170		DR8EA	13-7162	6,00	DR8EIX	13-6681	25,00
250		CR8HS	13-7423	6,90	CR8HIX	13-7669	25,00

DINLI		VAKIO/SUOSITUS			IRIDIUM		
malli	vm	Tyyppi	Tilnro.	Hinta	Tyyppi	Tilnro.	Hinta
50		BPR7HS	13-6422	6,30	BPR7HIX	13-5944	25,00
90		BPR7HS	13-6422	6,30	BPR7HIX	13-5944	25,00
100		BP6HS	13-4511	4,80	BPR6HIX	13-4085	25,00
150 4-T		C7HSA	13-4629	5,10	CR7HIX	13-7544	25,00
270		DPR7EA-9	13-5129	5,90	DPR7EIX-9	13-7803	25,00
300		DCPR8E	13-4339	11,70	DCPR8EIX	13-6546	25,00

ETON		VAKIO/SUOSITUS			IRIDIUM		
malli	vm	Tyyppi	Tilnro.	Hinta	Tyyppi	Tilnro.	Hinta
VIPER JUNIOR 40	03-	BPM7A	13-7321	5,20			
VIPER 50	02-	BPR7HS	13-6422	6,30	BPR7HIX	13-5944	25,00
SIERRA Ranger 90	03-	BPR7HS	13-6422	6,30	BPR7HIX	13-5944	25,00
VIPER 90	02-	BPR7HS	13-6422	6,30	BPR7HIX	13-5944	25,00
YUKON 150	99-	C7HSA	13-4629	5,10	CR7HIX	13-7544	25,00
VECTOR 250		CR8E	13-1275	13,20	CR8EIX	13-4218	25,00
VECTOR 300		CR8E	13-1275	13,20	CR8EIX	13-4218	25,00

GAS GAS		VAKIO/SUOSITUS			IRIDIUM		
malli	vm	Tyyppi	Tilnro.	Hinta	Tyyppi	Tilnro.	Hinta
250 QUAD	07-	DPR7EA-9	13-5129	5,90	DPR7EIX-9	13-7803	25,00
450 WILD	02-	CR8E	13-1275	13,20	CR8EIX	13-4218	25,00

HONDA		VAKIO/SUOSITUS			IRIDIUM		
malli	vm	Tyyppi	Tilnro.	Hinta	Tyyppi	Tilnro.	Hinta
TRX 70	87	CR7HS	13-7223	6,40	CR7HIX	13-7544	25,00
TRX 90	95-	CR7HSA	13-4549	6,50	CR7HIX	13-7544	25,00
ATC 200 E	83-85	DR8ES-L	13-2923	6,30	DR8EIX	13-6681	25,00
ATC 250 R	81-83	BR8ES	13-5422	6,00	BR8EIX	13-5044	25,00
ATC 250 ES	85-	DR8ES-L	13-2923	6,30	DR8EIX	13-6681	25,00
TRX 250	86	DR8ES-L	13-2923	6,30	DR8EIX	13-6681	25,00
TRX 250 R Trail		DPR6EA-9	13-5531	6,80			
TRX 250	97-11	DPR8EA-9	13-4929	6,00	DPR8EIX-9	13-2202	25,00
TRX 300	91-01	DPR8EA-9	13-4929	6,00	DPR8EIX-9	13-2202	25,00
TRX 300 X	09	DR8ES-L	13-2923	6,30	DR8EIX	13-6681	25,00
TRX 350	86-89	DR8ES-L	13-2923	6,30	DR8EIX	13-6681	25,00
TRX 350	00-05	DPR7EA-9	13-5129	5,90	DPR7EIX-9	13-7803	25,00
TRX 400EX	01-09	DPR8Z	13-4730	14,20			
TRX 400FA	04-05	DPR8EA-9	13-4929	6,00	DPR8EIX-9	13-2202	25,00
TRX 400FW	95-01	DPR7EA-9	13-5129	5,90	DPR7EIX-9	13-7803	25,00
TRX 420	07-13	BKR5E-11	13-6953	6,00			
TRX 450	98-04	DPR7EA-9	13-5129	5,90	DPR7EIX-9	13-7803	25,00
TRX 450R	04-09	IFR8H11	13-5068	47,00	IFR8H11	13-5068	47,00
TRX 500	02-07	IJR7A9	13-7901	45,70	IJR7A9	13-7901	45,70
TRX 500	08-11	BKR5E-11	13-6953	6,00			
TRX 650	03-05	IFR5L11	13-6502	50,50	IFR5L11	13-6502	50,50
TRX 680	06-10	IFR5L11	13-6502	50,50	IFR5L11	13-6502	50,50
TRX 700XX	09	ZFR7F-11	13-2975	5,50			

KAWASAKI		VAKIO/SUOSITUS			IRIDIUM		
malli	vm	Tyyppi	Tilnro.	Hinta	Tyyppi	Tilnro.	Hinta
KFX 50	03-	BPR4HS	13-7823	6,90			
KFX 90	07-12	CR7HSA	13-4549	6,50	CR7HIX	13-7544	25,00
KLF 185	85-88	DR8ES	13-5423	6,00	DR8EIX	13-6681	25,00
KLF 250	02-	DR8ES	13-5423	6,00	DR8EIX	13-6681	25,00
KLF 300	89-90	BR8ES	13-5422	6,00	BR8EIX	13-5044	25,00
KLF 300	91-08	DR7EA	13-7839	6,90			
KVF 360	03-	DPR8EA-9	13-4929	6,00	DPR8EIX-9	13-2202	25,00
KFX 400	03-07	CR7E	13-4578	13,20	CR7EIX	13-7385	25,00
KLF 400	93-99	DPR8EA-9	13-4929	6,00	DPR8EIX-9	13-2202	25,00
KVF 400	99-02	DPR8EA-9	13-4929	6,00	DPR8EIX-9	13-2202	25,00
MULE 450	91-96	D7EA	13-7912	5,80			
MULE 500	92-05	BP5ES	13-6511	4,80	BPR5EIX	13-6597	25,00



Vanteet ja renkaat



Talvituotteet



Vinsit



Laukut ja tuulisuojat



Sähköosat



Jousitus ja voimansiirto



Pakoputket ja suutinsarjat



Ohjaus



Rungon osat ja peitteet



Jarrupalat ja rattaat



Moottori



Variaattorin osat



Maatalous-tarvikkeet



Kärryt ja reet

ATV





SYTYTYSTULPAT JATKUU



Vanteet ja renkaat



Talvituotteet



Vinssit



Laukut ja tuulisuojat



Sähköosat



Jousitus ja voimansiirto



Pakoputket ja suutinsarjat



Ohjaus



Rungon osat ja peitteet



Jarrupalat ja rattaat



Moottori



Variaattorin osat



Maatalous-tarvikkeet



Kärryt ja reet

ATV

KAWASAKI		VAKIO/SUOSITUS			IRIDIUM		
malli	vm	Tyyppi	Tilnro.	Hinta	Tyyppi	Tilnro.	Hinta
MULE 540	01-05	BP5ES	13-6511	4,80	BPR5EIX	13-6597	25,00
MULE 550	97-04	BPR5ES	13-7422	5,50	BPR5EIX	13-6597	25,00
MULE 600	05-	BPR5ES	13-7422	5,50	BPR5EIX	13-6597	25,00
MULE 610	07-	BPR5ES	13-7422	5,50	BPR5EIX	13-6597	25,00
KFX 450	08-	CPR8EB-9	13-6607	12,80			
KVF 650	00-	CR7E	13-4578	13,20	CR7EIX	13-7385	25,00
KFX 700	04-	CR7E	13-4578	13,20	CR7EIX	13-7385	25,00
KVF 700	04	CR7E	13-4578	13,20	CR7EIX	13-7385	25,00
KVF 750	04-	CR7E	13-4578	13,20	CR7EIX	13-7385	25,00

KAZUMA		VAKIO/SUOSITUS			IRIDIUM		
malli	vm	Tyyppi	Tilnro.	Hinta	Tyyppi	Tilnro.	Hinta
59cc		C7HSA	13-4629	5,10	CR7HIX	13-7544	25,00
110cc		CR7HSA	13-4549	6,50	CR7HIX	13-7544	25,00
150cc		C7HSA	13-4629	5,10	CR7HIX	13-7544	25,00
250cc		CR7HSA	13-4549	6,50	CR7HIX	13-7544	25,00

KTM		VAKIO/SUOSITUS			IRIDIUM		
malli	vm	Tyyppi	Tilnro.	Hinta	Tyyppi	Tilnro.	Hinta
450 SX	09-	CR9EKB	13-2305	21,50			
450 XC	08-	DCPR8E	13-4339	11,70	DCPR8EIX	13-6546	25,00
505 SX	09-	CR9EKB	13-2305	21,50			
525 XC	08-	DCPR8E	13-4339	11,70	DCPR8EIX	13-6546	25,00

KYMCO		VAKIO/SUOSITUS			IRIDIUM		
malli	vm	Tyyppi	Tilnro.	Hinta	Tyyppi	Tilnro.	Hinta
50cc, MXer	02-	BR8HSA	13-5539	6,90	BPR8HIX	13-6742	25,00
90cc	04-05	C7HSA	13-4629	5,10	CR7HIX	13-7544	25,00
150cc MXer	01-05	CR8E	13-1275	13,20	CR8EIX	13-4218	25,00
250cc KXR	01-	DPR7EA-9	13-5129	5,90	DPR7EIX-9	13-7803	25,00
250cc MXU	05-	DPR7EA-9	13-5129	5,90	DPR7EIX-9	13-7803	25,00
500cc MXU	06-	CR8E	13-1275	13,20	CR8EIX	13-4218	25,00

LINHAI		VAKIO/SUOSITUS			IRIDIUM		
malli	vm	Tyyppi	Tilnro.	Hinta	Tyyppi	Tilnro.	Hinta
260 LINHAI 260cc		DR8EA	13-7162	6,00	DR8EIX	13-6681	25,00
450 LINHAI 300cc		DR8EA	13-7162	6,00	DR8EIX	13-6681	25,00

MINIFOX		VAKIO/SUOSITUS			IRIDIUM		
malli	vm	Tyyppi	Tilnro.	Hinta	Tyyppi	Tilnro.	Hinta
40cc		BPM7A	13-7321	5,20			
250cc		DR7ES	13-3123	7,00			

PANTHER		VAKIO/SUOSITUS			IRIDIUM		
malli	vm	Tyyppi	Tilnro.	Hinta	Tyyppi	Tilnro.	Hinta
100cc		C7HSA	13-4629	5,10	CR7HIX	13-7544	25,00

POLARIS		VAKIO/SUOSITUS			IRIDIUM		
malli	vm	Tyyppi	Tilnro.	Hinta	Tyyppi	Tilnro.	Hinta
50 Outlaw	08-09	CR6HSA	13-2983	6,80	CR6HIX	13-7274	25,00
50 Scrambler	01-03	BPR7HS	13-6422	6,30	BPR7HIX	13-5944	25,00
90 Outlaw	07-09	CR6HSA	13-2983	6,80	CR6HIX	13-7274	25,00
90 Predator	02-06	BPR7HS	13-6422	6,30	BPR7HIX	13-5944	25,00
90 Scrambler	02-03	BPR7HS	13-6422	6,30	BPR7HIX	13-5944	25,00
90 Sportsman	02-06	BPR7HS	13-6422	6,30	BPR7HIX	13-5944	25,00
90 Sportsman	07-09	CR6HSA	13-2983	6,80	CR6HIX	13-7274	25,00
200 Phoenix	05-	CR7HSA	13-4549	6,50	CR7HIX	13-7544	25,00
200 Sawtooth	06-	CR7HSA	13-4549	6,50	CR7HIX	13-7544	25,00
250 Trailblazer	02-06	BR8ES	13-5422	6,00	BR8EIX	13-5044	25,00
250 Xplorer	02-03	BR8ES	13-5422	6,00	BR8EIX	13-5044	25,00
300 Hawkeye	08-	CR8EB	13-7784	13,50	CR8EIX	13-4218	25,00
300 Sportsman	08-	CR8EB	13-7784	13,50	CR8EIX	13-4218	25,00
325 Magnum	00-02	BKR5E	13-7938	6,10	BKR5EIX	13-5464	25,00
325 Magnum	02-03	BKR6E	13-6962	5,90	BKR6EIX	13-6418	25,00
325 Trailboss	00-03	BKR6E	13-6962	5,90	BKR6EIX	13-6418	25,00

SYTYTYSTULPAT JATKUU



POLARIS		VAKIO/SUOSITUS			IRIDIUM		
malli	vm	Tyyppi	Tilnro.	Hinta	Tyyppi	Tilnro.	Hinta
325 Xpedition	02-03	BKR6E	13-6962	5,90	BKR6EIX	13-6418	25,00
330 Magnum	03-07	BKR6E	13-6962	5,90	BKR6EIX	13-6418	25,00
330 Trailboss	03-08	BKR6E	13-6962	5,90	BKR6EIX	13-6418	25,00
350 Big Boss	-95	BR8ES	13-5422	6,00	BR8EIX	13-5044	25,00
350 Trail Boss	90-93	BR8ES	13-5422	6,00	BR8EIX	13-5044	25,00
400 Scrambler	99-00	BR8ES	13-5422	6,00	BR8EIX	13-5044	25,00
400 Sportsman	03-06	BKR5E	13-7938	6,10	BKR5EIX	13-5464	25,00
400 Sportsman H.O	08-09	BKR6E	13-6962	5,90	BKR6EIX	13-6418	25,00
400 Trailblazer	03	BR8ES	13-5422	6,00	BR8EIX	13-5044	25,00
400 Xplorer	97-07	BR8ES	13-5422	6,00	BR8EIX	13-5044	25,00
425 Magnum	96-98	BKR5E	13-7938	6,10	BKR5EIX	13-5464	25,00
425 Xpedition	00-03	BKR5E	13-7938	6,10	BKR5EIX	13-5464	25,00
450 Outlaw MXR	09	DCPR8E	13-4339	11,70	DCPR8EIX	13-6546	25,00
500 Big Boss 6X6	98-02	BKR5E	13-7938	6,10	BKR5EIX	13-5464	25,00
500 Magnum	95-04	BKR5E	13-7938	6,10	BKR5EIX	13-5464	25,00
500 Predator	03-08	DCPR8E	13-4339	11,70	DCPR8EIX	13-6546	25,00
500 Ranger 6X6	01-04	BKR5E	13-7938	6,10	BKR5EIX	13-5464	25,00
500 Scrambler	97-09	BKR6E	13-6962	5,90	BKR6EIX	13-6418	25,00
500 Sportsman	96-08	BKR5E	13-7938	6,10	BKR5EIX	13-5464	25,00
500 Sportsman Efi, H.O	09-	BKR6E	13-6962	5,90	BKR6EIX	13-6418	25,00
500 Sportsman 6X6	01-08	BKR5E	13-7938	6,10	BKR5EIX	13-5464	25,00
525 Outlaw	09	DCPR8E	13-4339	11,70	DCPR8EIX	13-6546	25,00
600 Sportsman	03-06	BKR7E	13-6097	7,50	BKR7EIX	13-2667	25,00
650 Ranger	06-	BPR5ES	13-7422	5,50	BPR5EIX	13-6597	25,00
700 Sportsman	03-08	BKR7E	13-6097	7,50	BKR7EIX	13-2667	25,00
800 Sportsman	05-	BKR7E	13-6097	7,50	BKR7EIX	13-2667	25,00
800 Sportsman X2	07-	BKR6ES	13-3783	6,20	BKR6EIX	13-6418	25,00
850 XP		LZKAR7A	13-6799	12,40			

Rally		VAKIO/SUOSITUS			IRIDIUM		
malli	vm	Tyyppi	Tilnro.	Hinta	Tyyppi	Tilnro.	Hinta
49cc		B6HS	13-4510	5,10	BR6HIX	13-3419	25,00
150cc		C7HSA	13-4629	5,10	CR7HIX	13-7544	25,00
250cc		DR8EA	13-7162	6,00	DR8EIX	13-6681	25,00

SUZUKI		VAKIO/SUOSITUS			IRIDIUM		
malli	vm	Tyyppi	Tilnro.	Hinta	Tyyppi	Tilnro.	Hinta
LT50	-01	BPR4HS	13-7823	6,90			
LT-A50	02-05	BPR4HS	13-7823	6,90			
LT-Z50	06-	CR6HSA	13-2983	6,80	CR6HIX	13-7274	25,00
LT80	86-90	BP7HS	13-5111	4,90	BPR7HIX	13-5944	25,00
LT80	91-06	BPR7HS	13-6422	6,30	BPR7HIX	13-5944	25,00
LT-Z90	07-	CR6HSA	13-2983	6,80	CR6HIX	13-7274	25,00
LT160E	89	DR7EA	13-7839	6,90			
LT160E	90-92	DPR7EA-9	13-5129	5,90	DPR7EIX-9	13-7803	25,00
LT-F160	92-07	DPR7EA-9	13-5129	5,90	DPR7EIX-9	13-7803	25,00
LT250EF	85-86	DR8ES-L	13-2923	6,30	DR8EIX	13-6681	25,00
LT250R	85-87	B8EGV	13-5627	27,30			
LT-F250	02-12	DR7EA	13-7839	6,90			
LT-F4WD 250	-94	DR7ES	13-3123	7,00			
LT-Z250	03-09	DR7EA	13-7839	6,90			
LT-F4WD 280	93-94	DR7ES	13-3123	7,00			
LT-F4WD 280	95-	DR7EA	13-7839	6,90			
LT-F300	99-01	DR7EA	13-7839	6,90			
LT-F/A400	02-12	CR7E	13-4578	13,20	CR7EIX	13-7385	25,00
LT-Z400	03-12	CR7E	13-4578	13,20	CR7EIX	13-7385	25,00
LT-A450	07-	CR6E	13-6965	13,60			
LT-R450	06-	CR8EB	13-7784	13,50	CR8EIX	13-4218	25,00
LT-F/A500F	98-99	CR7E	13-4578	13,20	CR7EIX	13-7385	25,00
LT-F/A500F	00-07	CR6E	13-6965	13,60			
LT-A500Xi	11-12	CR6E	13-6965	13,60			
LTA700 KINGQUAD	05-	CR6E	13-6965	13,60			
LT-V700 TWINPEAKS	04-05	CR7E	13-4578	13,20	CR7EIX	13-7385	25,00
LT-A750, Xi	08-12	CR6E	13-6965	13,60			



Vanteet ja renkaat



Talvituotteet



Vinsit



Laukut ja tuulisuojat



Sähköosat



Jousitus ja voimansiirto



Pakoputket ja suutinsarjat



Ohjaus



Rungon osat ja peitteet



Jarrupalat ja rattaat



Moottori



Variaattorin osat



Maatalous-tarvikkeet



Kärryt ja reet

ATV





SYTYTYSTULPAT JATKUU



Vanteet ja renkaat



Talvituuotteet



Vinssit



Laukut ja tuulisuojat



Sähköosat



Jousitus ja voimansiirto



Pakoputket ja suutinsarjat



Ohjaus



Rungon osat ja peitteet



Jarrupalat ja rattaat



Moottori



Variaattorin osat



Maatalous-tarvikkeet



Kärryt ja reet

TGB		VAKIO/SUOSITUS			IRIDIUM		
malli	vm	Tyyppi	Tilnro.	Hinta	Tyyppi	Tilnro.	Hinta
HORNET 2-T 49cc		BPR7HS	13-6422	6,30	BPR7HIX	13-5944	25,00
250cc		CR8E	13-1275	13,20	CR8EIX	13-4218	25,00
Blade 325		CR8E	13-1275	13,20	CR8EIX	13-4218	25,00
Blade 425	10-	CR7E	13-4578	13,20	CR7EIX	13-7385	25,00
Blade 450	10-	CR7E	13-4578	13,20	CR7EIX	13-7385	25,00
Blade 460	12-	CR7E	13-4578	13,20	CR7EIX	13-7385	25,00
Blade 550	11-	CR7E	13-4578	13,20	CR7EIX	13-7385	25,00
Target 550	11-	CR7E	13-4578	13,20	CR7EIX	13-7385	25,00

YAMAHA		VAKIO/SUOSITUS			IRIDIUM		
malli	vm	Tyyppi	Tilnro.	Hinta	Tyyppi	Tilnro.	Hinta
YFM 50	03-05	CR7HS	13-7223	6,40	CR7HIX	13-7544	25,00
YFM 50	06-	CR7HSA	13-4629	5,10	CR7HIX	13-7544	25,00
YFM 80		CR7HSA	13-4629	5,10	CR7HIX	13-7544	25,00
YFM 90 Raptor	09-10	CR7HSA	13-4629	5,10	CR7HIX	13-7544	25,00
YFM 100		CR7HS	13-7223	6,40	CR7HIX	13-7544	25,00
YFM 125 / Breeze	89-03	CR7HS	13-7223	6,40	CR7HIX	13-7544	25,00
YFM 125 Grizzly	04-09	CR7HSA	13-4629	5,10	CR7HIX	13-7544	25,00
YFM 200	92-	D7EA	13-7912	5,80			
YFS 200 Blaster	90-04	BR8ES	13-5422	6,00	BR8EIX	13-5044	25,00
YFM 225		DR7ES	13-3123	7,00			
YFM 250/Bear Tracker	98-04	DR7EA	13-7839	6,90			
YFM 250 Raptor	08-09	DR7EA	13-7839	6,90			
YFM 350	89-01	DR8ES-L	13-2923	6,30	DR8EIX	13-6681	25,00
YFM 350 Big Bear	88-99	D8EA	13-2120	5,00	DR8EIX	13-6681	25,00
YFM 350 Grizzly	07-10	DR8EA	13-7162	6,00	DR8EIX	13-6681	25,00
YFM 350 Warrior	90-96	D8EA	13-2120	5,00	DR8EIX	13-6681	25,00
YFM 350 Warrior	97-04	DR8EA	13-7162	6,00	DR8EIX	13-6681	25,00
YFM 350 Wolverine	04-07	D8EA	13-2120	5,00	DR8EIX	13-6681	25,00
YFM 350/Bruin 350	04-06	DR8EA	13-7162	6,00	DR8EIX	13-6681	25,00
YFZ 350/R	03-04	BR8ES	13-5422	6,00	BR8EIX	13-5044	25,00
YFM 400 Kodiak	93-99	D8EA	13-2120	5,00	DR8EIX	13-6681	25,00
YFM 400 Big Bear/Kodiak	00-10	DR8EA	13-7162	6,00	DR8EIX	13-6681	25,00
YFM 450 F	03-10	DR8EA	13-7162	6,00	DR8EIX	13-6681	25,00
YFZ 450	05-10	CR8E	13-1275	13,20	CR8EIX	13-4218	25,00
YFM 550 Grizzly	09-	LMAR6A-9	13-5946	30,80			
YFM 600	98-01	DPR8EA-9	13-4929	6,00	DPR8EIX-9	13-2202	25,00
YFM 660 Grizzly	02-08	DPR8EA-9	13-4929	6,00	DPR8EIX-9	13-2202	25,00
YFM 660 Raptor	01-05	DPR8EA-9	13-4929	6,00	DPR8EIX-9	13-2202	25,00
YXR 660 Rhino	-08	DPR8EA-9	13-4929	6,00	DPR8EIX-9	13-2202	25,00
YFM 700 Grizzly	08	CPR7EA-9	13-3901	14,30			
YFM 700 Grizzly	09-	LMAR7A-9	13-4908	23,10			
YFM 700 Raptor	06-	CR8E	13-1275	13,20	CR8EIX	13-4218	25,00
YXR 700 Rhino	08-09	CPR7EA-9	13-3901	14,30			



DV RACING PICS

ATV



71-01112



71-01117



71-01120



71-01127



Vanteet ja renkaat



Talvituotteet



Vinsit



Laukut ja tuulisuojat



Sähköosat



Jousitus ja voimansiirto



Pakoputket ja suutinsarjat



Ohjaus



Rungon osat ja peitteet



Jarrupalat ja rattaat



Moottori



Variaattorin osat



Maatalous-tarvikkeet



Kärryt ja reet



71-190710



71-190711



71-190712



71-190713



71-190716



71-190717



71-190718



71-190719



71-190721



71-190722



71-190723



71-190724



71-190725



71-190726



71-190727



71-190728



71-190729



71-190730



71-190732



71-190733



71-190734



71-195100



71-195101



71-217080/71-217081



71-217084



303-3214



303-3218



STARTTIMOOTTORIT SOPIVUUEDET

BRONCO
ATV COMPONENTS

ARCTIC CAT	vm	tuotenro	Korvaa alkup.nr.	hinta
250	1999-05	71-190729	3545-003, 3545-017	220,00
300	1998-05	71-190729	3545-003, 3545-017	220,00
375 AUTOMATIC	2002	71-01117	3545-016	220,00
400	2003-13	71-01117	3545-016	220,00
400	1998-04	71-190716	3545-015, 3454-012	220,00
500	2000-09	71-190716	3545-015, 3454-012	220,00
550	2009-14	71-207463	0825-013, 0825-024	220,00
650	2005-12	71-207463	0825-013, 0825-024	220,00
700	2006-14	71-207463	0825-013, 0825-024	220,00
1000 TRV, PROWLER, MUD PRO	2009-13	71-207457	0825-015, 0825-025	180,00

BOMB/CAN-AM	vm	tuotenro	Korvaa alkup.nr.	hinta
400 OUTLANDER	2007-12	71-207452	420684280	165,00
500 OUTLANDER	2007-13	71-207476	420685560	220,00
500 RENEGADE	2008-13	71-207476	420685560	220,00
500 TRAXXTER	2001-05	71-190717	711296125	276,00
650 OUTLANDER	2006-12	71-207476	420685560	220,00
800 COMMANDER	2011-12	71-207476	420685560	220,00
800 OUTLANDER	2006-13	71-207476	420685560	220,00
800 RENEGADE	2007-13	71-207476	420685560	220,00
1000 COMMANDER	2011-12	71-207476	420685560	220,00
1000 OUTLANDER	2012	71-207476	420685560	220,00
1000 RENEGADE	2012	71-207476	420685560	220,00

HONDA	vm	tuotenro	Korvaa alkup.nr.	hinta
ATC 250	1985-86	71-190730	31200-HA0-682	220,00
ATC 250	1987	71-190731	31200-HA0-774	220,00
TRX 250	1985-86	71-190730	31200-HA-682	220,00
TRX 250	1987	71-190731	31200-HA0-774	220,00
TRX 300	1988-00	71-190718	31200-HC4-033	220,00
TRX 300EX	1993-08	71-190728	31200-HM3-671	220,00
TRX 350A, D	1987-89	71-190732	31200-HA7-773	220,00
TRX 350FE, FM, TE, TM RANCHER	2000-06	71-01127	31200-HN5-M01, A81, 671	220,00
TRX 400EX	1999-04	71-190733	31200-HN1-000	220,00
TRX 400FW FORE-MAN	1995-01	71-190719	31200-HM7-003	220,00
TRX 420	2007-13	71-207460	31200-HP5-601	220,00
TRX 450 ES, S	1998-01	71-190719	31200-HM7-003	220,00
TRX 500 FA, FPA, FGA	2001-13	71-207456	31200-HN2-003	165,00
TRX 650, 680 RINCON	2003-13	71-01112	31200-HN8-000, 31200-HN8-003	220,00

KAWASAKI	vm	tuotenro	Korvaa alkup.nr.	hinta
KEF 300 LAKOTA	1995-00	71-190720	21163-1141	220,00
KEF 300 B LAKOTA	2001-03	71-190720	21163-1141	220,00
KLF 300 B, C BAYOU	1989-04	71-190720	21163-1141	220,00
KVF 300 A, B PRAIRIE	1999-02	71-190720	21163-1141	220,00
KLF 400 B BAYOU	1993-99	71-190721	21163-1208	220,00
KVF 400 B PRAIRIE	1997-98	71-190721	21163-1208	220,00
KVF 400 C, D PRAIRIE	1998-02	71-190721	21163-1208	220,00
KVF 650, 750 BRUTE FORCE	2002-12	71-01120	21163-0037, 21163-1320	220,00
TERRYX 750	2008-13	71-01120	21163-0037, 21163-1320	220,00

POLARIS	vm	tuotenro	Korvaa alkup.nr.	hinta
300	1994-95	71-190713	3085393	220,00
400L	1994-95	71-190713	3085393	220,00
ATP 330	2004-05	71-190712	3084981	220,00
ATP 500	2004-05	71-190712	3084981	220,00
BIG BOSS 250	1989-93	71-190713	3085393	220,00
BIG BOSS 300	1994	71-190713	3085393	220,00
BIG BOSS 350L	1993	71-190713	3085393	220,00
BIG BOSS 400L	1994-96	71-190713	3085393	220,00
BIG BOSS 500	1998-99	71-190712	3084981	220,00
BIG BOSS 500	1999-02	71-190712	3084981	220,00
MAGNUM 325	2000-02	71-190712	3084981	220,00
MAGNUM 330	2003-06	71-190712	3084981	220,00
MAGNUM 425	1995-98	71-190712	3084981	220,00
MAGNUM 500	2000-03	71-190712	3084981	220,00
PRO 500 PPS	2002	71-190712	3084981	220,00
PVT SERIES	2003	71-190712	3084981	220,00
RANGER 400	2010-12	71-190712	3090188	220,00
RANGER 500	2004-07	71-190712	3084981	220,00

POLARIS	vm	tuotenro	Korvaa alkup.nr.	hinta
RANGER RZR 800 EFI	2008-11	71-190710	4010417	220,00
SCRAMBLER 250	1985-86	71-190713	3085393	220,00
SCRAMBLER 400L	1995-02	71-190713	3085393	220,00
SCRAMBLER 500	1997-12	71-190712	3084981	220,00
SPORT 400L	1994-99	71-190713	3085393	220,00
SPORTSMAN 335	1999-00	71-190712	3084981	220,00
SPORTSMAN 350	1993	71-190713	3085393	220,00
SPORTSMAN 400	1994-97	71-190713	3085393	220,00
SPORTSMAN 400	2001-05	71-190712	3084981	220,00
SPORTSMAN 400 HO	2011-12	71-190712	3090188	220,00
SPORTSMAN 450	2006-07	71-190712	3084981	220,00
SPORTSMAN 500	1996-12	71-190712	3084981	220,00
SPORTSMAN 500 EFI TRACTOR	2010	71-190712	3084981	220,00
SPORTSMAN 500 H.O, X2	2006-08	71-190712	3084981	220,00
SPORTSMAN 500 HO	2009-12	71-190712	3090188	220,00
SPORTSMAN 600	2004-06	71-190710	4010417	220,00
SPORTSMAN 700	2006-10	71-190710	4010417	220,00
SPORTSMAN 800	2005-13	71-190710	4010417	220,00
SPORTSMAN X2 700, 800	2007-08	71-190710	4010417	220,00
TRAIL BLAZER 250	1991	71-190713	3085393	220,00
TRAIL BLAZER 250	1997-06	71-190713	3085393	220,00
TRAIL BLAZER 400	2003-06	71-190713	3085393	220,00
TRAIL BOSS 250	1985-99	71-190713	3085393	220,00
TRAIL BOSS 325	2000-02	71-190712	3084981	220,00
TRAIL BOSS 330	2003-13	71-190712	3084981	220,00
TRAIL BOSS 350L	1990-93	71-190713	3085393	220,00
WORKER 335	1999	71-190712	3084981	220,00
WORKER 500	1999-01	71-190712	3084981	220,00
XPEDITION 325	2000-02	71-190711	3086240	220,00
XPEDITION 425	2000-02	71-190711	3086240	220,00
XPLOER 300	1996-99	71-190713	3085393	220,00
XPLOER 400	1995-02	71-190713	3085393	220,00
XPLOER 500	1997	71-190712	3084981	220,00
XPRESS 300	1996-99	71-190713	3085393	220,00
XPRESS 400	1996	71-190713	3085393	220,00

SUZUKI	vm	tuotenro	Korvaa alkup.nr.	hinta
LT 160 QUADRUNNER	1989-92	71-190722	31100-02C10	220,00
LTF 160 QUADRUNNER	1993-01	71-190722	31100-02C10	220,00
LTF 250 OZARK	2002-03	71-190722	31100-02C10	220,00
LTF 250 QUADRUNNER	1988-01	71-190729	31100-19B12, 31100-19B20	220,00
LTF 250	2002-09	71-190722	31100-02C10	220,00
LTF 250	2004-09	71-190722	31100-02C10	220,00
LTF 250 4WD QUAD-RUNNER	1987-02	71-190729	31100-19B12, 31100-19B20	220,00
LTF 300 KING QUAD	1991-02	71-190729	31100-19B12, 31100-19B20	220,00
LTA, LTF 400 EIGER	2002-10	71-01117	31100-38F00	220,00
KING QUAD 450	2007-10	71-207462	31100-11H00	220,00
LTA 500X	2009-13	71-207462	31100-11H00	220,00
KING QUAD 700	2005-07	71-207457	31100-31G00	220,00
KING QUAD 750	2008-11	71-207457	31100-31G00	220,00

YAMAHA	vm	tuotenro	Korvaa alkup.nr.	hinta
YFM 50 RAPTOR	2004-	71-190727	55X-81800-51, 55X-81800-50	220,00
YFM 80 BADGER	1985-04	71-190727	55X-81800-51, 55X-81800-50	220,00
YFM 80 RAPTOR	2002-08	71-190727	55X-81800-51, 55X-81800-50	220,00
YFM 100 CHAMPION	1987-92	71-190727	55X-81800-51, 55X-81800-50	220,00
YFM 200 MOTO-4	1985-89	71-190724	29-U-81800-61-00, 29U-81800-60-00	220,00
YTM 200 TRI-MOTO	1983-85	71-190724	29-U-81800-61-00, 29U-81800-60-00	220,00
YTM 225 TRI-MOTO	1983-87	71-190724	29-U-81800-61-00, 29U-81800-60-00	220,00
YFB 250 TIMBER-WOLF	1992-96	71-190726	48D-81800-00, 48D-81800-01	220,00



STARTTIMOOTTORIT JATKUU

YAMAHA	vm	tuotenumero	Korvaa alkup.nr.	hinta
YFB 250 4WD TIM-BERWOLF	1995-00	71-190726	4BD-81800-00, 4BD-81800-01	220,00
YFM 250 BEAR TRACKER	1999-04	71-190726	4BD-81800-00, 4BD-81800-01	220,00
YFM 350 MOTO-4	1987-95	71-190723	4YW-81800-51-00, 2HR-81800-52-00	220,00
YFM 350 BIG BEAR	1995-96	71-190723	4YW-81800-51-00, 2HR-81800-52-00	220,00
YFM 350 4WD BIG BEAR	1987-98	71-190723	4YW-81800-51-00, 2HR-81800-52-00	220,00
YRM 350 GRIZZLY	2007-12	71-207448	3HE-81890-00-00	165,00
YFM 350 RAPTOR	2006-09	71-190723	4YW-81800-51-00, 2HR-81800-52-00	220,00
YFM 350 WARRIOR	1987-04	71-190723	4YW-81800-51-00, 2HR-81800-52-00	220,00
YFP 350 TERRA PRO	1988	71-190723	4YW-81800-51-00, 2HR-81800-52-00	220,00
YFM 350 BIG BEAR	1998-00	71-190725	4KB-81890-00, 4KB-81800-00	220,00
YFM 350 WOLVERINE	1995-04	71-190725	4KB-81890-00, 4KB-81800-00	220,00
YFM 400	2000-06	71-190723	4YW-81800-51-00, 2HR-81800-52-00	220,00
YFM 400 BIG BEAR	2000-09	71-190725	4KB-81890-00, 4KB-81800-00	220,00
YFM 400 GRIZZLY	2008-10	71-195100	5KM-81890-00-00	220,00
YFM 400 KODIAK	1993-98	71-190723	4YW-81800-51-00, 2HR-81800-52-00	220,00

YAMAHA	vm	tuotenumero	Korvaa alkup.nr.	hinta
YFM 400 KODIAK	1999	71-190725	4KB-81890-00, 4KB-81800-00	220,00
YFM 400 KODIAK	2000-02	71-190734	4WV-81890-00, 4WV-81800-00	220,00
YFM 400 KODIAK	2003-08	71-195100	5KM-81890-00-00	220,00
YFM 450 GRIZZLY	2008-12	71-195100	5KM-81890-00-00	220,00
YFM 450 KODIAK	2003-08	71-195100	5KM-81890-00-00	220,00
450 WOLVERINE	2006-09	71-195100	5KM-81890-00-00	220,00
GRIZZLY 550	2009-13	71-207466	28P-81890-00-00	220,00
GRIZZLY 600	1998-01	71-190734	4WV-81890-00, 4WV-81800-00	220,00
GRIZZLY 660	2002-08	71-195100	5KM-81890-00-00	220,00
GRIZZLY 700	2009-13	71-207466	28P-81890-00-00	220,00
YFM 660 RAPTOR	2001-05	71-195101	3SX-81890-00-00	220,00

KIINA ATV	vm	tuotenumero	Korvaa alkup.nr.	hinta
GY6 50cc		303-3214		38,00
GY6 125-150cc		303-3218		38,00
250cc 4-Stroke 68x153mm (CF engine)		71-217084		130,00
CG vertical 150-300cc Air cooled 9 teeth		71-217080		130,00
CG vertical 150-250cc Air cooled 11 teeth		71-217081		130,00

STARTTIMOOTTORIN VARAOSIA

Hiilenpidikelevyt

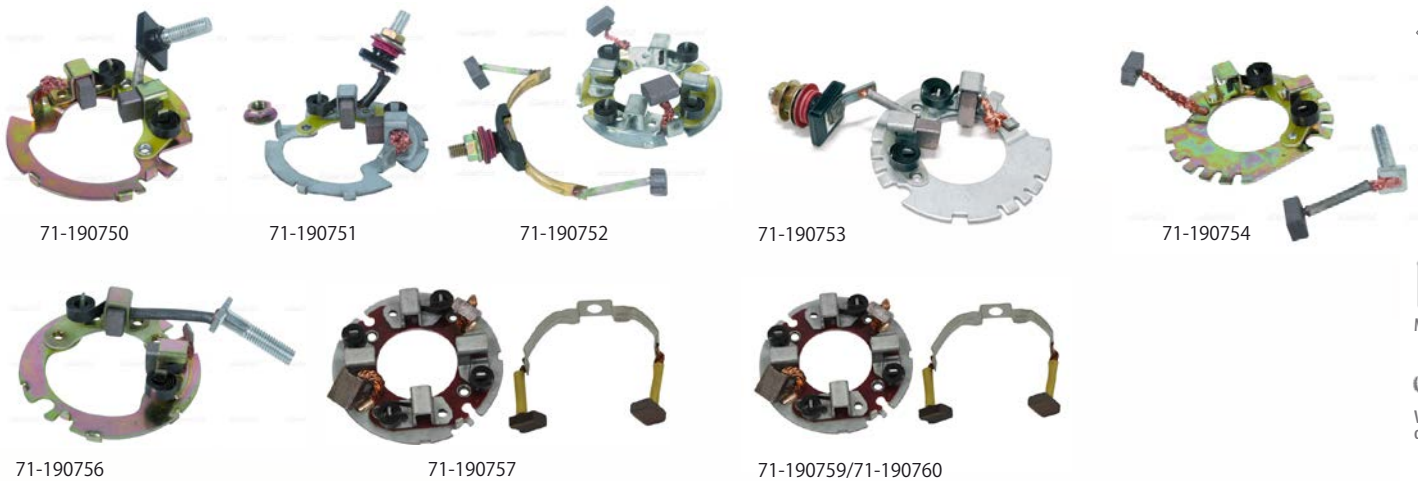

ARCTIC CAT	vm	tuotenumero	Korvaa alkup.nr.	hinta
250	1999-05	71-190755		32,30
300	1998-05	71-190755		32,30
375 AUTOMATIC	2002	71-190756	3545-016	32,30
400	1998-04	71-190752	3545-015,3454-012	32,30
400	2003-08	71-190756	3545-016	32,30
400 MANUAL	2009	71-190752	3545-015,3454-012	32,30
500	2000-09	71-190752	3545-015,3454-012	32,30
BOMB/CAN-AM	vm	tuotenumero	Korvaa alkup.nr.	hinta
TRAXXTER	2001-05	71-190753		32,30
HONDA	vm	tuotenumero	Korvaa alkup.nr.	hinta
TRX 300	1988-00	71-190750		32,30
TRX 350	1987-89	71-190751		32,30
TRX 350FW	1990-94	71-190751		32,30
TRX 400 FOREMAN	1995-01	71-190750		32,30
TRX 450 ES,S	1998-01	71-190750		32,30
TRX 650,680 RINCON	2003-10	71-190759		32,30

KAWASAKI	vm	tuotenumero	Korvaa alkup.nr.	hinta
KEF 300 LAKOTA	1995-00	71-190750		32,30
KEF 300 B LAKOTA	2001-03	71-190750		32,30
KLF 300 B,C BAYOU	1989-04	71-190750		32,30
KVF 300 A,B PRAIRIE	1999-02	71-190750		32,30
KLF 400 B BAYOU	1993-99	71-190750		32,30
KVF 400 B PRAIRIE	1997-98	71-190750		32,30
KVF 400 C,D PRAIRIE	1999-02	71-190750		32,30
POLARIS	vm	tuotenumero	Korvaa alkup.nr.	hinta
USEIMMAT MALLIT	1991-14	71-190751		32,30
BIG BOSS 250	1989-93	71-190751		32,30
TRAIL BLAZER 250	1991	71-190751		32,30
TRAIL BLAZER 250	1997-06	71-190751		32,30
TRAIL BOSS 250	1985-99	71-190751		32,30
SCRAMBLER 250	1985-86	71-190751		32,30
300	1994-95	71-190751		32,30
BIG BOSS 300	1994	71-190751		32,30



Vanteet ja renkaat



Talvituet



Vinsit



Laukut ja tuulisuojat



Sähköosat



Jousitus ja voimansiirto



Pakoputket ja suutinsarjat



Ohjaus



Ungon osat i peitteet



arrupalat ja ittaät



Moottori



Variaattorin osat



Maatalous-tarvikkeet



Kärryt ja reet



Kärryt ja reet



Kärryt ja reet



Kärryt ja reet



Kärryt ja reet



Vanteet ja renkaat



Talvituotteet



Vinssit



Laukut ja tuulisuojat



Sähköosat



Jousitus ja voimansiirto



Pakoputket ja suutinsarjat



Ohjaus



Rungon osat ja peitteet



Jarrupalat ja rattaat



Moottori



Variaattorin osat



Maatalous-tarvikkeet



Kärryt ja reet

POLARIS	vm	tuotenro	Korvaa alkup.nr.	hinta
XPLOER 300	1996-99	71-190751		32,30
XPRESS 300	1996-99	71-190751		32,30
MAGNUM 325	2000-02	71-190751		32,30
TRAIL BOSS 325	2000-02	71-190751		32,30
XPEDITION 325	2000-02	71-190752		32,30
ATP 330	2004-05	71-190751		32,30
MAGNUM 330	2003-06	71-190751		32,30
TRAIL BOSS 330	2003-10	71-190751		32,30
SPORTSMAN 335	1999-00	71-190751		32,30
WORKER 335	1999	71-190751		32,30
BIG BOSS 350L	1993	71-190751		32,30
TRAIL BOSS 350L	1990-93	71-190751		32,30
SPORTSMAN 350	1993	71-190751		32,30
400L	1994-95	71-190751		32,30
BIG BOSS 400L	1994-96	71-190751		32,30
HAWKEYE 400 HO	2011	71-190751		32,30
RANGER 400	2010-12	71-190751		32,30
SCRAMBLER 400L	1995-02	71-190751		32,30
SPORT 400L	1994-99	71-190751		32,30
SPORTSMAN 400	1994-97	71-190751		32,30
SPORTSMAN 400	2001-05	71-190751		32,30
SPORTSMAN 400 HO	2011-12	71-190751		32,30
TRAIL BLAZER 400	2003	71-190751		32,30
XPLOER 400	1995-02	71-190751		32,30
XPRESS 400	1996	71-190751		32,30
MAGNUM 425	1995-98	71-190751		32,30
XPEDITION 425	2000-01	71-190752		32,30
SPORTSMAN 450	2006-07	71-190751		32,30
ATP 500	2004-05	71-190751		32,30
BIG BOSS 500	1998-99	71-190751		32,30
BIG BOSS 500	1999-02	71-190751		32,30
MAGNUM 500	2000-03	71-190751		32,30
PRO 500 PPS	2002	71-190751		32,30
RANGER 500	2004-10	71-190751		32,30
SCRAMBLER 500	1997-10	71-190751		32,30
SPORTSMAN 500	1996-07	71-190751		32,30
SPORTSMAN 500 H.O,X2	2006-12	71-190751		32,30
SPORTSMAN 550	2013-14	71-190751		32,30
WORKER 500	1999-01	71-190751		32,30
XPLOER 500	1997	71-190751		32,30
SPORTSMAN 600	2004-06	71-190752		32,30
SPORTSMAN 700	2002-06	71-190752		32,30
SPORTSMAN X2 700	2007-08	71-190752		32,30
SPORTSMAN 800	2005-08	71-190752		32,30
SPORTSMAN 800	2010-11	71-190751		32,30
SPORTSMAN X2 800	2007-08	71-190752		32,30
PVT SERIES	2003	71-190751		32,30
SUZUKI	vm	tuotenro	Korvaa alkup.nr.	hinta
LT 160 QUADRUNNER	1989-92	71-190755		32,30
LTF 160 QUADRUNNER	1993-01	71-190755		32,30
LTF 250	2008-09	71-190755		32,30
LTF 250 OZARK	2002-03	71-190755		32,30
LTF 250 QUADRUNNER	1988-01	71-190755		32,30
LTF 250 4WD QUADRUNNER	1987-02	71-190755		32,30
LTF 250	2008-09	71-190755		32,30
LTF 300 KING QUAD	1991-99	71-190755		32,30
YAMAHA	vm	tuotenro	Korvaa alkup.nr.	hinta
YFM 50 RAPTOR	2004-	71-190758		32,30
YFM 80 BADGER	1985-04	71-190758		32,30
YFM 80 RAPTOR	2002	71-190758		32,30
YFM 100 CHAMPION	1987-92	71-190758		32,30
YFM 200 MOTO-4	1985-89	71-190757		32,30
YTM 200 TRI-MOTO	1983-85	71-190757		32,30
YTM 225 TRI-MOTO	1983-87	71-190757		32,30
YFB 250 TIMBERWOLF	1992-96	71-190755		32,30
YFB 250 4WD TIMBERWOLF	1995-00	71-190755		32,30
YFN 250 BEAR TRACKER	1999-04	71-190755		32,30
YFM 350 MOTO-4	1987-95	71-190754		32,30

YAMAHA	vm	tuotenro	Korvaa alkup.nr.	hinta
YFM 350 BIG BEAR	1995-96	71-190754		32,30
YFM 350 4WD BIG BEAR	1987-98	71-190754		32,30
YFM 350 WARRIOR	1987-04	71-190754		32,30
YFP 350 TERRA PRO	1988	71-190754		32,30
YFM 350 BIG BEAR	1998-00	71-190753		32,30
YFM 350 RAPTOR	2006-09	71-190753		32,30
YFN 350 WOLVERINE	1995-04	71-190753		32,30
YFM 400	2000-06	71-190754		32,30
YFM 400 KODIAK	1993-98	71-190754		32,30
YFM 400 BIG BEAR	2000-08	71-190753		32,30
YFM 400 KODIAK	1999	71-190753		32,30
GRIZZLY 400	2007-08	71-190760		32,30
GRIZZLY 450	2007-11	71-190760		32,30
KODIAK 450	2003-06	71-190760		32,30
WOLVERINE 450	2006-10	71-190760		32,30
GRIZZLY 600,660,700	1998-08	71-190760		32,30
RHINO 700	2008-11	71-190760		32,30



Solenoidit

ARCTIC CAT	vm	tuotenro	Korvaa alkup.nr.	hinta
USEIMMAT MALLIT	1996-	71-01099	12V 30amp	28,30
BOMBARDIER	vm	tuotenro	Korvaa alkup.nr.	hinta
USEIMMAT MALLIT	1999-03	71-01099	12V 30amp	28,30
USEIMMAT MALLIT	2008-15	71-01752	710001364	28,30
HONDA	vm	tuotenro	Korvaa alkup.nr.	hinta
USEIMMAT MALLIT	1986-14	71-01099	12V 30amp	28,30
TRX 400 FOREMAN	1995-03	71-01097	12V 80amp	28,30
TRX 500 FOREMAN	2001-03	71-01097	12V 80amp	28,30
TRX 500	2004-14	71-01101		28,30
KAWASAKI	vm	tuotenro	Korvaa alkup.nr.	hinta
USEIMMAT MALLIT	1984-12	71-01099	12V 30amp	28,30
POLARIS	vm	tuotenro	Korvaa alkup.nr.	hinta
USEIMMAT MALLIT	1985-	71-01098	3083211,3085521	28,30
SPORTSMAN 500 HO	2001-12	71-01099	12V 30amp	28,30
SUZUKI	vm	tuotenro	Korvaa alkup.nr.	hinta
USEIMMAT MALLIT	1987-09	71-01696	12V 30amp	28,30
YAMAHA	vm	tuotenro	Korvaa alkup.nr.	hinta
USEIMMAT MALLIT	1982-09	71-01099	12V 30amp	28,30
USEIMMAT MALLIT	1992-14	71-01100	45V-81940-00-00	32,30



STARTTIMOOTTORIN VARAOSIA



Bendixit

CAN-AM	vm	tuotenro	Korvaa alkup.nr.	hinta
OUTLANDER 330/400	2003-14	71-01148	420684050/420684051	95,80
POLARIS	vm	tuotenro	Korvaa alkup.nr.	hinta
SPORTMAN 600	2003-05	71-058797	4010418,4012614	95,80
SPORTMAN 700	2002-08	71-058797	4010418,4012614	95,80
SPORTMAN 800	2008-14	71-058797	4010418,4012614	95,80
RANGER RZR	2005-14	71-058797	4010418,4012614	95,80
USEIMMAT MALLIT	1985-14	71-158724	3087030,3083647,3085394	90,50



71-058797
71-058724



71-01148

Magneetot

POLARIS	vm	tuotenro	Korvaa alkup.nr.	hinta
TRAIL BOSS 330	2004-08	71-195065	3089275	283,50
MAGNUM 330	2004-06	71-195065	3089275	283,50
ATP 330	2005-06	71-195065	3089275	283,50
TRAIL BLAZER	2008	71-195065	3089275	283,50



Staattorin pick-upit

HONDA	vm	tuotenro	Korvaa alkup.nr.	hinta
USEIMMAT MALLIT	1986-12	71-195021	30300-HA0-033	29,50
TRX 500	vm	tuotenro	Korvaa alkup.nr.	hinta
KAWASKI	vm	tuotenro	Korvaa alkup.nr.	hinta
KVF 360 PRAIRIE	2003-06	71-195037	59026-1110	59,90
KLF 400 B BAYOU	1993-99	71-195037	59026-1110	59,90
KVF 400 PRAIRIE	1997-02	71-195037	59026-1110	59,90
KVF 650 PRAIRIE	2002-03	71-195039	59026-1159	49,90
KVF 650 BRUTE FORCE	2005-13	71-195039	59026-1159	49,90
KSF 700 V-FORCE	2004-05	71-195039	59026-1159	49,90
KVF 700 PRAIRIE	2004-06	71-195039	59026-1159	49,90
POLARIS	vm	tuotenro	Korvaa alkup.nr.	hinta
USEIMMAT MALLIT	1996-04	71-195064	3085360	54,90
RANGER 500	2005-09	71-195064	3085360	54,90



Releet

HONDA	vm	tuotenro	Korvaa alkup.nr.	hinta
TRX420FA FOURTRAX RANCHER	2009-13	71-01361	38580-HP5-601	23,60
TRX420FE RANCHER 420 ES 4x4	2007-13	71-01361	38580-HP5-601	23,60
TRX420FM RANCHER	2007-13	71-01361	38580-HP5-601	23,60
TRX420FPA FOURTRAX RANCHER AT	2009-13	71-01361	38580-HP5-601	23,60
TRX420FPE RANCHER 420 ES EPS 4x4	2009-13	71-01361	38580-HP5-601	23,60
TRX420FPM RANCHER	2009-13	71-01361	38580-HP5-601	23,60
TRX420TE FOURTRAX RANCHER Es	2007-13	71-01361	38580-HP5-601	23,60
TRX420TM FOURTRAX RANCHER	2007-13	71-01361	38580-HP5-601	23,60
TRX500FE FOREMAN ES 4x4	2012-13	71-01361	38580-HP5-601	23,60
TRX500FM FOREMAN 4x4	2012-13	71-01361	38580-HP5-601	23,60
TRX500FF FOREMAN 4x4	2012-13	71-01361	38580-HP5-601	23,60
TRX500FPE FOREMAN 500 ES EPS 4x4	2012-13	71-01361	38580-HP5-601	23,60
TRX500FPM FOREMAN 500 EPS 4x4	2012-13	71-01361	38580-HP5-601	23,60
TRX680FA FOURTRAX RINCON	2008-13	71-01361	38580-HP5-601	23,60
TRX680FGA FOURTRAX RINCON GPSCAPE	2008-09	71-01361	38580-HP5-601	23,60
TRX700XX	2008-09	71-01361	38580-HP5-601	23,60



uutuus!



Yleisrele 4-5-napainen



Tuotenro	Tuote	Ovh
9-3-3820	Yleisrele 12V30A 5-nap./pole	7,50
9-3-3821	Yleisrele 12V30A 4-nap./pole	7,50

JÄNNITTEENSÄÄTIMET

ARCTIC CAT	VM	Tuotenro	Hinta	OEM
375 AUTO	2002	71-01219	72,00	(3530-028/3530-059/3402-682 (SUZUKI#32800-44D31)
400 2x4	2002-04	71-01219	72,60	(3530-028/3530-059/3402-682 (SUZUKI#32800-44D31)
400 4x4	2002-06	71-01219	72,60	(3530-028/3530-059/3402-682 (SUZUKI#32800-44D31)
400 4x4 ACT	2003-04	71-01219	72,60	(3530-028/3530-059/3402-682 (SUZUKI#32800-44D31)
400 4x4 Automatic	2003-06	71-01219	72,60	(3530-028/3530-059/3402-682 (SUZUKI#32800-44D31)
400 4x4 Automatic ACT	2003-04	71-01219	72,60	(3530-028/3530-059/3402-682 (SUZUKI#32800-44D31)
400 4x4 Automatic LE	2005-06	71-01219	72,60	(3530-028/3530-059/3402-682 (SUZUKI#32800-44D31)
400 4x4 Automatic TBX	2004-06	71-01219	72,60	(3530-028/3530-059/3402-682 (SUZUKI#32800-44D31)
400 4x4 Automatic VP	2005-06	71-01219	72,60	(3530-028/3530-059/3402-682 (SUZUKI#32800-44D31)
400 4x4 VP	2005-06	71-01219	72,60	(3530-028/3530-059/3402-682 (SUZUKI#32800-44D31)



71-01211



Vanteet ja renkaat



Talvituotteet



Vinssit



Laukut ja tuulisuojat



Sähköosat



Jousitus ja voimansiirto



Pakoputket ja suutinsarjat



Ohjaus



Rungon osat ja peitteet



Jarrupalat ja rattaat



Moottori



Variaattorin osat



Maatalous-tarvikkeet



Kärryt ja reet



JÄNNITTEENSÄÄTIMET JATKUU

BRONCO

ATV COMPONENTS



Vanteet ja renkaat



Talvituotteet



Vinssit



Laukut ja tuulisuojat



Sähköosat



Jousitus ja voimansiirto



Pakoputket ja suutinsarjat



Ohjaus



Rungon osat ja peitteet



Jarrupalat ja rattaat



Moottori



Variaattorin osat



Maatalous-tarvikkeet



Kärryt ja reet

ARCTIC CAT	VM	Tuotenro	Hinta	OEM
400 DVX	2004-06	71-01219	72,60	(3530-028/3530-059/3402-682 (SUZUKI#32800-44D31)
400i 2x4/4x4	2002-03	71-01219	72,60	(3530-028/3530-059/3402-682 (SUZUKI#32800-44D31)
400 FIS 2x4, 4x4	2003	71-01219	72,60	(3530-028/3530-059/3402-682 (SUZUKI#32800-44D31)
400 2x4, 4x4	2004-08	71-01219	72,60	(3530-028/3530-059/3402-682 (SUZUKI#32800-44D31)
500 2x4	2002	71-01219	72,60	(3530-028/3530-059/3402-682 (SUZUKI#32800-44D31)
500 4x4	2002-06	71-01219	72,60	(3530-028/3530-059/3402-682 (SUZUKI#32800-44D31)
500 4x4 Automatic LE	2005-06	71-01219	72,60	(3530-028/3530-059/3402-682 (SUZUKI#32800-44D31)
500 4x4 Automatic MRP	2003	71-01219	72,60	(3530-028/3530-059/3402-682 (SUZUKI#32800-44D31)
500 4x4 Automatic TBX	2002-06	71-01219	72,60	(3530-028/3530-059/3402-682 (SUZUKI#32800-44D31)
500 4x4 Automatic TRV	2004-06	71-01219	72,60	(3530-028/3530-059/3402-682 (SUZUKI#32800-44D31)
500i 4x4	2002-03	71-01219	72,60	(3530-028/3530-059/3402-682 (SUZUKI#32800-44D31)
500i 4x4 Automatic	2002-04	71-01219	72,60	(3530-028/3530-059/3402-682 (SUZUKI#32800-44D31)
500 4x4	2008-09	71-01219	72,60	(3530-028/3530-059/3402-682 (SUZUKI#32800-44D31)
CAN-AM	VM	Tuotenro	Hinta	OEM
Outlander 1000	2012-14	71-01657	79,00	(710000908/ 710000261/710001103)
Outlander 330/400	2004-14	71-01657	79,00	(710000908/ 710000261/710001103)
Outlander 400 EFI STD/XT/MAX	2008-10	71-01227	113,00	(710001103 FET)
Outlander 500	2008-14	71-01657	79,00	(710000908/ 710000261/710001103)
Outlander 500 4x4/XT/STD/MAX	2007-08	71-01227	113,00	
Outlander 500 EFI STD/XT/MAX	2009-10	71-01227	113,00	
Outlander 650	2008-14	71-01657	79,00	(710000908/ 710000261/710001103)
Outlander 650 4x4/XT/STD/MAX	2006-08	71-01227	113,00	
Outlander 650 EFI XT/MAX	2009-10	71-01227	113,00	
Outlander 800	2008-14	71-01657	79,00	(710000908/ 710000261/710001103)
Outlander 800 4x4/XT/STD/MAX	2006-08	71-01227	113,00	
Outlander 800R EFI XT/LTD/MAX	2009-11	71-01227	113,00	
Renegade 1000	2012-14	71-01657	79,00	(710000908/ 710000261/710001103)
Renegade 500	2008-14	71-01657	79,00	(710000908/ 710000261/710001103)
Renegade 500 / EFI	2008-10	71-01227	113,00	
Renegade 800 / 800X	2008	71-01227	113,00	
Renegade 800R	2008-14	71-01657	79,00	(710000908/ 710000261/710001103)
Renegade 800R EFI	2009-11	71-01227	113,00	
HONDA	VM	Tuotenro	Hinta	OEM
TRX250EX	2001-11	71-01212	52,50	(31600-HM8-013)
TRX250 Recon	1997-11	71-01212	52,50	(31600-HM8-013)
TRX300EX	1993-05	71-01213	69,60	(31600-HM3-003, 31600-HM3-A61,3160-HM3-901)
TRX300EX	2005-06	71-01213	69,60	(31600-HM3-003, 31600-HM3-A61,3160-HM3-901)
TRX350 Rancher	2000-06	71-01226	83,70	(31600-HN5-671)
TRX400 Foreman	1995-03	71-01226	83,70	(31600-HN5-671)
TRX400EX	1999-04	71-01212	52,50	(31600-HM8-013)
TRX400EX	2005-13	71-01212	52,50	(31600-HM8-013)
TRX420 ALL	2007-13	71-01211	69,60	(31600-HP5-601)
TRX450R	2004-05	71-01226	83,70	(31600-HN5-671)
TRX450S/ES Foreman	1998-01	71-01226	83,70	(31600-HN5-671)
TRX500FA/FGA Foreman Rubicon	2005-08	71-01227	113,00	
TRX500FA/FPA Fourtrax Foreman Rubicon	2009	71-01227	113,00	
"TRX500FE/FM/FPE/FPM Fourtrax				
Foreman EPS/ES 4x4 "	2007-11	71-01227	113,00	
"TRX500FE/FM/TM Fourtrax				
Foreman 4x4 / ES "	2005-06	71-01227	113,00	
TRX650FA/FGA Rincon / GPS	2003-05	71-01227	113,00	
TRX680FA/FGA Fourtrax Rincon / GPScape	2006-14	71-01227	113,00	
KAWASAKI	VM	Tuotenro	Hinta	OEM
Bayou 300	1998-04	71-01214	99,90	(21066-1112)
Prairie 360	2003-10	71-01214	99,90	(21066-1112)
Prairie 400	1999-02	71-01214	99,90	(21066-1112)
KFX400	2003-07	71-01215	73,00	(21066-1112)
Brute Force 650	2005-13	71-01214	99,90	(21066-1112)
Prairie 650	2002-03	71-01214	99,90	(21066-1112)
KFX700	2004-09	71-01214	99,90	(21066-1112)
Prairie 700	2004-06	71-01214	99,90	(21066-1112)
KAF 620 Mule 3000	2001-08	81-612	74,00	(21066-1127)
KAF 620 Mule 3010 4x4	2001-08	81-612	74,00	(21066-1127)
KAF 620 Mule 3020 Turf	2001-03	81-612	74,00	(21066-1127)
KYMCO	VM	Tuotenro	Hinta	OEM
Mongoose 250	2003-07	71-01214	99,90	
Mongoose 300	2006-07	71-01214	99,90	
MXU 150	2004-07	71-01214	99,90	
MXU 250	2005-07	71-01214	99,90	
MXU 300	2006-07	71-01214	99,90	



JÄNNITTEENSÄÄTIMET JATKUU

POLARIS	VM	Tuotenro	Hinta	OEM
Magnum 325 2X4 HDS	2000-02	71-01229	68,60	(4060208,4060191)
Magnum 325 2X4	2000-02	71-01229	68,60	(4060208,4060191)
Magnum 325 4X4	1998-02	71-01229	68,60	(4060208,4060191)
Ranger	SERIES 11	71-01229	68,60	(4060208,4060191)
Ranger	SERIES 10	71-01229	68,60	(4060208,4060191)
Sportsman 335	1999-00	71-01229	68,60	(4060208,4060191)
Sportsman 400	2001-02	71-01229	68,60	(4060208,4060191)
Trsail Boss	2000-02	71-01229	68,60	(4060208,4060191)
Worker 335	1999	71-01229	68,60	(4060208,4060191)
Xpedition 325	2000-02	71-01229	68,60	(4060208,4060191)
Xpedition 425	2000-02	71-01229	68,60	(4060208,4060191)
Xplorar 400	1998-02	71-01229	68,60	(4060208,4060191)
Xpress 300	1996-97	71-01229	68,60	(4060208,4060191)
Xpress 400	1996-97	71-01229	68,60	(4060208,4060191)
Xplorar 400	1996-97	71-01229	68,60	(4060208,4060191)
Big Boss 6x6 400L	1996-97	71-01229	68,60	(4060208,4060191)
Magnum 425	1996-97	71-01229	68,60	(4060208,4060191)
Sportsman 400	1996-97	71-01229	68,60	(4060208,4060191)
Sportsman 500	1996-97	71-01229	68,60	(4060208,4060191)
Magnum 500 4x4 RMK	1999-01	71-01231	68,60	(4060173,2203636)
Magnum 500 4x4 w/EBS	1999-01	71-01231	68,60	(4060173,2203636)
Magnum 500 4x4 w/o EBS	2000	71-01231	68,60	(4060173,2203636)
Scrambler 500 2x4	1997-02	71-01231	68,60	(4060173,2203636)
Sportsman 500 4x4	1998-01	71-01231	68,60	(4060173,2203636)
Sportsman 500 4x4 RSE	2000-01	71-01231	68,60	(4060173,2203636)
Sportsman Touring 500 EFI	2008-09	71-01237	96,80	(4011925, 4011569)
Sportsman 500 EFI	2008	71-01237	96,80	(4011925, 4011569)
Sportsman 500 EFI Tractor	2008-10	71-01237	96,80	(4011925, 4011569)
Sportsman 700	2002-03	71-01231	68,60	(4060173,2203636)
Sportsman 700 EFI	2007	71-01237	96,80	(4011925, 4011569)
Sportsman Touring 800 EFI	2008-09	71-01237	96,80	(4011925, 4011569)
Sportsman 800 EFI	2007-08	71-01237	96,80	(4011925, 4011569)
Sportsman 800 HO EFI	2008-09	71-01237	96,80	(4011925, 4011569)
Sportsman 800 EFI 6x6	2009-10	71-01237	96,80	(4011925, 4011569)
Sportsman X2 800 EFI	2008-09	71-01237	96,80	(4011925, 4011569)
Worker 500 4x4	1998-02	71-01231	68,60	(4060173,2203636)
Ranger	1999	71-01231	68,60	(4060173,2203636)
Ranger 500 EFI	2008-09	71-01237	96,80	(4011925, 4011569)
Ranger 500 6x6	Series 10	71-01231	68,60	(4060173,2203636)
Ranger 570	2014-	71-01227	113,00	(4012941)
Ranger 700 EFI/XP	2007-09	71-01237	96,80	(4011925, 4011569)
Ranger 700 EFI 6x6	2007-09	71-01237	96,80	(4011925, 4011569)
Ranger RZR 800	2008-10	71-01237	96,80	(4011925, 4011569)
Ranger 4x4 800 EFI/CREW	2011-14	71-01227	113,00	(4012941)
Ranger 6x6 800 EFI	2011-14	71-01227	113,00	(4012941)
Ranger RZR 800 EFI +EPS	2011-12	71-01227	113,00	(4012941)
Ranger RZR "S" 800 EFI	2011-12	71-01227	113,00	(4012941)
Ranger RZR 4/EPS RGE	2011-12	71-01227	113,00	(4012941)
SUZUKI	VM	Tuotenro	Hinta	OEM
LT-F250	2002-09	71-01215	68,60	(32800-05F10/20)
LTZ250	2004-09	71-01215	68,60	(32800-05F10/20)
LTZ400	2003-09	71-01215	68,60	(32800-05F10/20)
LT-4WD	1987-97	71-01232	68,60	(32800-19B11)
LT-4WDX	1997	71-01232	68,60	(32800-19B11)
LT-4WDXW	1996-98	71-01232	68,60	(32800-19B11)
LT-F160	1991-04	71-01232	68,60	(32800-19B11)
LT-F250F	1999-02	71-01232	68,60	(32800-19B11)
LT-F250	1988-01	71-01232	68,60	(32800-19B11)
LT-F300F	1999-02	71-01232	68,60	(32800-19B11)
LT-F4WD	1997-98	71-01232	68,60	(32800-19B11)
LT-F4WDW	1997-98	71-01232	68,60	(32800-19B11)
LT-F4WDX	1995-97	71-01232	68,60	(32800-19B11)
LT-F4WDXS	1991-95	71-01232	68,60	(32800-19B11)
LT-A 400	2002-08	81-612	68,60	(32800-38F10,32800-42F00)
LT-A 400	2002-09	81-612	68,60	(32800-38F10,32800-42F00)
LT-A 400 C	2003-05	81-612	68,60	(32800-38F10,32800-42F00)
LT-A450X/XZ	2007-09	81-612	68,60	(32800-38F10,32800-42F00)
LT-A500F	2002-07	81-612	68,60	(32800-38F10,32800-42F00)
LT-A500XP/XPZ	2009-13	81-612	68,60	(32800-38F10,32800-42F00)
LT-A700X	2006-07	81-612	68,60	(32800-38F10,32800-42F00)
LT-A750X/XP/XZ/XPZ	2008-13	81-612	68,60	(32800-42F00)
YAMAHA	VM	Tuotenro	Hinta	OEM
Grizzly 125	2004-09	71-01216	60,50	(5GT-81960-00-00)
Moto-4 225	1986-91	71-01234	113,00	(59V-81960-A0-00)
Moto-4 250	1986-91	71-01234	113,00	(59V-81960-A0-00)
BearTracker 250	2001-04	71-01216	60,50	(5GT-81960-00-00)
Bruin 250	2005-06	71-01216	60,50	(5GT-81960-00-00)
Big Bear 250	2007-09	71-01216	60,50	(5GT-81960-00-00)



71-01227



71-01229



71-01231



71-01232



81-612

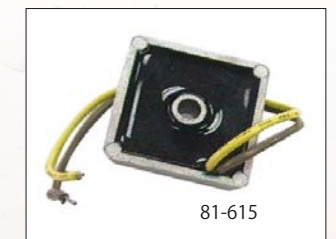

81-615



Vanteet ja renkaat



Talvituotteet



Vinsit



Laukut ja tuulisuojat



Sähköosat



Jousitus ja voimansiirto



Pakoputket ja suutinsarjat



Ohjaus



Rungon osat ja peitteet



Jarrupalat ja rattaat



Moottori



Variaattorin osat



Maatalous-tarvikkeet



Kärkyt ja reet

ATV





JÄNNITTEENSÄÄTIMET JATKUU



Vanteet ja renkaat



Talvituotteet



Vinssit



Laukut ja tuulisuojat



Sähköosat



Jousitus ja voimansiirto



Pakoputket ja suutinsarjat



Ohjaus



Rungon osat ja peitteet



Jarrupalat ja rattaat



Moottori



Variaattorin osat



Maatalous-tarvikkeet



Kärryt ja reet

YAMAHA	VM	Tuotenumero	Osh.	OEM
Raptor 250	2008-09	71-01216	60,50	(5GT-81960-00-00)
Moto-4 350	1990-94	71-01234	113,00	(59V-81960-A0-00)
Big Bear 350	1987-94	71-01234	113,00	(59V-81960-A0-00)
Warrior 350	1987-95	71-01234	113,00	(59V-81960-A0-00)
Wolverine 350	2006-09	71-01216	60,50	(5GT-81960-00-00)
Raptor 350	2004-09	71-01216	60,50	(5GT-81960-00-00)
Bruin 350	2004-06	71-01216	60,50	(5GT-81960-00-00)
Grizzly 350	2007-09	71-01216	60,50	(5GT-81960-00-00)
Grizzly 400	2007-08	71-01216	60,50	(5GT-81960-00-00)
Big Bear 400	2002-09	71-01216	60,50	(5GT-81960-00-00)
Kodiak 400	2000-06	71-01216	60,50	(5GT-81960-00-00)
Kodiak 450	2003-06	71-01216	60,50	(5GT-81960-00-00)
YFZ450R	2009	71-01657	79,00	(5BN-81960-00-00)
Wolverine 450	2006-09	71-01216	60,50	(5GT-81960-00-00)
Rhino 450	2006-09	71-01657	79,00	(5BN-81960-00-00)
Grizzly 450	2007-09	71-01657	79,00	(5BN-81960-00-00)
Grizzly 550	2009-14	71-01227	113,00	(1D7-81960-00-00)
Grizzly 600	1999-01	71-01216	60,50	(5GT-81960-00-00)
Raptor 660	2001-05	71-01216	60,50	(5GT-81960-00-00)
Grizzly 660	2002-08	71-01657	79,00	(5BN-81960-00-00)
Grizzly 700	2007-14	71-01227	113,00	(1D7-81960-00-00)
Rhino 660	2004-07	71-01657	79,00	(5BN-81960-00-00)
Rhino 700	2008-14	71-01227	113,00	(1D7-81960-00-00)
Raptor 700	2006-09	71-01657	79,00	(5BN-81960-00-00)
Raptor 700	2010-12	110-07-0592	127,00	(1D7-81960-00-00)
Viking 700	2014	71-01227	113,00	(1D7-81960-00-00)
YLEISMALLI	VM	Tuotenumero	Hinta	OEM
12V KÄSIKÄYNNISTYKSELLÄ		81-615	28,00	2-Johtoinen
12V SÄHKÖKÄYNNISTYKSELLÄ		81-616-1	51,00	4-Johtoinen

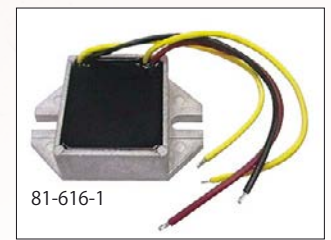

81-616-1



81-612

SYTYTYSPUOLAT



71-01300-1



71-01321



71-1302



71-195026



71-195027



71-195028



71-195029



71-195031



71-195032



71-195033



71-195034



71-195035



71-195043



71-195044



71-195045



71-195047



71-195058



71-195059



71-195060



71-195061



71-195062



71-195068



71-195069



71-195070



71-195081



71-195203



81-01149

ATV



CAN-AM	vm	tuotenumro	Korvaa alkup.nr.	hinta
Traxter 5 Speed	2005-11	81-01149	278001546	117,90
Traxter Auto Std & XT	2004-11	81-01149	278001546	117,90
Traxter Autoshift Std	2003-11	81-01149	278001546	117,90
Traxter Autoshift XT	2003-11	81-01149	278001546	117,90
Outlander 500 EFI XT	2009-13	81-01149	278001546	117,90
Outlander 500 EFI	2009-13	81-01149	278001546	117,90
Outlander 650 EFI XT	2009-13	81-01149	278001546	117,90
Outlander 650 EFI	2009-13	81-01149	278001546	117,90
Outlander 800R EFI XT	2009-13	81-01149	278001546	117,90
Outlander 800R EFI	2009-13	81-01149	278001546	117,90
Outlander Max 500 EFI Ltd	2009-14	81-01149	278001546	117,90
Outlander Max 500 EFI XT	2009-14	81-01149	278001546	117,90
Outlander Max 500 EFI	2009-12	81-01149	278001546	117,90
Outlander Max 650 EFI XT,	2009-14	81-01149	278001546	117,90
Outlander Max 650 EFI	2009-14	81-01149	278001546	117,90
Outlander Max 800R EFI Ltd	2009-14	81-01149	278001546	117,90
Outlander Max 800R EFI XT	2009-14	81-01149	278001546	117,90
Outlander Max 800R EFI	2009-14	81-01149	278001546	117,90
Outlander 1000	2012-14	81-01149	278001546	117,90
Renegade 500 EFI	2009-14	81-01149	278001546	117,90
Renegade 500	2009-14	81-01149	278001546	117,90
Renegade 800R EFI STD	2009-14	81-01149	278001546	117,90
Renegade 800R EFI X	2009-14	81-01149	278001546	117,90
Renegade 800R EFI	2009-14	81-01149	278001546	117,90
SPYDER	2012-14	81-01149	278001546	117,90
HONDA	vm	tuotenumro	Korvaa alkup.nr.	hinta
TRX 70	1986-87	71-195029	30510-KT0-405	49,90
TRX 125	1985-88	71-195029	30510-KT0-405	49,90
ATC 200X	1986	71-195029	30510-KT0-405	49,90
TRX 200SX	1986-88	71-195029	30510-KT0-405	49,90
TRX 250 RECON	1997-01	71-195027	30510-HM8-000	76,90
TRX 250 RECON	2002-14	71-195081	30510-HN6-000	49,90
TRX 250 TE A	2002-14	71-195081	30510-HN6-000	49,90
TRX 250	1985-87	71-195029	30510-KT0-405	49,90
TRX 250R	1986-89	71-195029	30510-KT0-405	49,90
TRX 250X	1987	71-195029	30510-KT0-405	49,90
TRX 300	1993-00	71-195026	30510-HM5-670	45,90
TRX 300FW	1993-00	71-195026	30510-HM5-670	45,90
ATC 350X	1985-86	71-195029	30510-KT0-405	49,90
TRX 350D	1987-89	71-195029	30510-KT0-405	49,90
TRX 350FW	1990-92	71-195029	30510-KT0-405	49,90
TRX 350 FE,ES RANCHER	2000-06	71-195031	30510-HN5-670	45,90
TRX 350FM RANCHER	2000-06	71-195031	30510-HN5-670	45,90
TRX 350TE RANCHER	2000-06	71-195031	30510-HN5-670	45,90
TRX 350TM RANCHER	2000-06	71-195031	30510-HN5-670	45,90
TRX 400 FOREMAN	1995-03	71-195028	30510-HM7-003	49,90
TRX 400EX SPORT	1999-06	71-195203	30500-HN1-000	65,90
TRX 420	2007-14	71-01321	30510-HP5-601	49,90
TRX 450 ES FOREMAN	1998-01	71-195028	30510-HM7-003	45,90
TRX 450 FE,ES FOREMAN	2002-04	71-195028	30510-HM7-003	45,90
TRX 450 S FOREMAN	1998-01	71-195028	30510-HM7-003	45,90
TRX 450 FM FOREMAN	2002-04	71-195028	30510-HM7-003	45,90
KAWASAKI	vm	tuotenumro	Korvaa alkup.nr.	hinta
KLT 200 A	1981-83	71-195032	21121-1049	55,90
KLT 200 B	1983	71-195032	21121-1049	55,90

POLARIS	vm	tuotenumro	Korvaa alkup.nr.	hinta
KLT 200 C	1983-84	71-195032	21121-1049	55,90
KLF 220 A BAYOU	1988-95	71-195034	21121-1198	76,90
KLF 220 A BAYOU	1996-02	71-195034	21121-1198	76,90
KLF 220 A BAYOU	2003-05	71-195034	21121-1198	76,90
KLT 250 A	1982-83	71-195032	21121-1049	55,90
KLT 250 C	1983-85	71-195032	21121-1049	55,90
KLF 300 C BAYOU	1997-04	71-195033	21121-1264	55,90
KLF 300 A BAYOU	1986-87	71-195032	21121-1049	55,90
KLF 300 B BAYOU	1988-04	71-195032	21121-1049	55,90
KLF 300 C BAYOU	1989-96	71-195032	21121-1049	55,90
KVF 300 A PRAIRIE	1999-02	71-195034	21121-1198	76,90
KVF 300 B PRAIRIE	1999-02	71-195034	21121-1198	76,90
KVF 360 PRAIRIE	2003-06	71-195034	21121-1198	76,90
KLF 400 B BAYOU	1993-99	71-195034	21121-1198	76,90
KVF 400 PRAIRIE	1997-03	71-195034	21121-1198	76,90
KVF 650 BRUTE FORCE	2003-13	71-195035	21121-1292	36,90
KVF 650 BRUTE FORCE	2003-13	71-195036	21121-1306	29,90
KVF 700 PRAIRIE	2004-06	71-195035	21121-1292	36,90
KVF 700 PRAIRIE	2004-06	71-195036	21121-1306	29,90
POLARIS	vm	tuotenumro	Korvaa alkup.nr.	hinta
400L	1994-95	71-195058	3083923	79,90
APT 500 H.O	2004	71-195059	3084979	79,90
ATP 330	2004-05	71-195061	3087036	79,90
BIG BOSS 250 4x6,6x6	1989-93	71-195058	3083923	79,90
BIG BOSS 300 6x6	1994	71-195058	3083923	79,90
BIG BOSS 350L 6x6	1993	71-195058	3083923	79,90
BIG BOSS 400L 6x6	1994-97	71-195058	3083923	79,90
BIG BOSS 500 6x6	1998-99	71-195060	3085227	109,90
BIG BOSS 500 6x6	1998-99	71-195060	3085227	109,90
MAGNUM 330	2003-06	71-195061	3087036	79,90
MAGNUM 425	1995-98	71-195059	3084979	79,90
MAGNUM 500	2000-03	71-195059	3084979	79,90
MAGNUM 500	1999	71-195060	3085227	109,90
MAGNUM 500	1999	71-195060	3085227	109,90
PREDATOR 500	2003-07	71-195062	3088053	46,90
PREDATOR 500	2003-07	71-195062	3088053	46,90
RANGER 2x4,4x4,6x6	2004-05	71-195060	3085227	109,90
RANGER 500	2006-08	71-195060	3085227	109,90
RANGER 800	2008-14	81-01149	4010425	116,90
RANGER 900	2011-14	81-01149	4010425	116,90
RANGER RZR	2009-14	81-01149	4010425	116,90
SCRAMBLER 400	1995-02	71-195058	3083923	79,90
SCRAMBLER 500	1997-03	71-195059	3084979	79,90
SCRAMBLER 850,1000	2014	81-01149	4010425	116,90
SPORT 400L	1994-99	71-195058	3083923	79,90
SPORTSMAN 335	1999	71-195059	3084979	79,90
SPORTSMAN 350	1993	71-195058	3083923	79,90
SPORTSMAN 400	1994-97	71-195058	3083923	79,90
SPORTSMAN 400	2001	71-195059	3084979	79,90
SPORTSMAN 400	2002-03	71-195060	3085227	109,90
SPORTSMAN 400	2002-03	71-195060	3085227	109,90
SPORTSMAN 400 HO	2012-13	71-195060	3085227	109,90
SPORTSMAN 500	1996-03	71-195060	3085227	109,90
SPORTSMAN 500 HO	2001-13	71-195060	3085227	109,90
SPORTSMAN 700 EFI	2005-07	81-01149	4010425	116,90
SPORTSMAN 700	2004	81-01149	4010425	116,90
SPORTSMAN 800 EFI	2005-13	81-01149	4010425	116,90
SPORTSMAN 800 EFI	2008	81-01149	4010425	116,90
SPORTSMAN 800 EFI 6X6	2009-13	81-01149	4010425	116,90
SPORTSMAN 800 HO EFI	2007-13	81-01149	4010425	116,90
SPORTSMAN TOURING 800 EFI	2008-09	81-01149	4010425	116,90



Vanteet ja renkaat



Talvituet



Vinsit



Laukut ja tuulisuojat



Sähköosat



Jousitus ja voimansiirto



Pakoputket ja suutinsarjat



Ohjaus



Rungon osat ja peitteet



Jarrupalat ja rattaat



Moottori



Variaattorin osat



Maatalous-tarvikkeet



Kärryt ja reet



Kärryt ja reet



Kärryt ja reet



Kärryt ja reet



Kärryt ja reet



Kärryt ja reet

ATV



SYTYTYSPUOLAT JATKUU



BRONCO
ATV COMPONENTS



Vanteet ja renkaat



Talvituotteet



Vinssit



Laukut ja tuulisuojat



Sähköosat



Jousitus ja voimansiirto



Pakoputket ja suutinsarjat



Ohjaus



Rungon osat ja peitteet



Jarrupalat ja rattaat



Moottori



Variaattorin osat



Maatalous-tarvikkeet



Kärryt ja reet

SPORTSMAN TOURING 800 EFI INTL	2008-09	81-01149	4010425	116,90
SPORTSMAN TOURING EPS 850	2010	81-01149	4010425	116,90
SPORTSMAN X2 700 EFI	2008	81-01149	4010425	116,90
SPORTSMAN X2 800 EFI	2007-09	81-01149	4010425	116,90
SPORTSMAN XP 850/INTL	2009-14	81-01149	4010425	116,90
SPORTSMAN XP EPS 850/INTL	2009-14	81-01149	4010425	116,90
TRAIL BLAZER 250	1990-06	71-195058	3083923	79,90
TRAIL BLAZER 330	2008-13	71-195061	3087036	79,90
TRAIL BLAZER 400	2003	71-195058	3083923	79,90
TRAIL BOSS 250	1988-99	71-195058	3083923	79,90
TRAIL BOSS 300	1994-95	71-195058	3083923	79,90
TRAIL BOSS 330	2002-13	71-195061	3087036	79,90
TRAIL BOSS 350L	1990-93	71-195058	3083923	79,90
XPEDITION 425	2000-02	71-195059	3084979	79,90
XPLORER 250	2000-02	71-195058	3083923	79,90
XPLORER 300	1996-99	71-195058	3083923	79,90
XPLORER 400	1995-02	71-195058	3083923	79,90
XPLORER 500	1997	71-195060	3085227	109,90
XPLORER 500	1997	71-195060	3085227	109,90
XPRESS 300	1996-99	71-195058	3083923	79,90
XPRESS 400L	1996-97	71-195058	3083923	79,90

SUZUKI	vm	tuotenro	Korvaa alkup.nr.	hinta
LT 80 QUADRUNNER, QUAD SPORT	2000-06	71-195044	33410-22AV0	59,90
ALT125 3-PYÖRÄINEN	1983-85	71-195045	33410-09411	59,90
LT 125 QUADRUNNER	1983-84	71-195045	33410-09411	59,90
LT 160 QUADRUNNER	1989-92	71-195047	33410-02C00	59,90
LTF 160 QUADRUNNER	1993-01	71-195047	33410-02C00	59,90
ALT185 3-PYÖRÄINEN	1983-85	71-195045	33410-09411	59,90
LT 185 QUADRUNNER	1984-87	71-195045	33410-09411	59,90
LT 230 QUADRUNNER	1985-93	71-195044	33410-22AV0	59,90
LT 230 QUADSPORT	1985-88	71-195044	33410-22AV0	59,90
LTF 230 QUADRUNNER	1986-87	71-195044	33410-22AV0	59,90
LTF 250 QUADRUNNER	1990-00	71-195043	33410-01X50	66,90
LT 250 QUADSPORT	1989-90	71-195044	33410-22AV0	59,90
LTF 250 QUADRUNNER	1988-89	71-195044	33410-22AV0	59,90

YAMAHA	vm	tuotenro	Korvaa alkup.nr.	hinta
LT 250 QUADRACER	1987-91	71-195045	33410-09411	59,90
LTF 300 KING QUAD	1991-00	71-195043	33410-01X50	66,90
LT 300E QUADRUNNER	1987-88	71-195045	33410-09411	59,90
LTF 300 QING QUAD	1987-89	71-195045	33410-09411	59,90
LTF 400 QUAD SPORT	2003-06	71-195069	33410-09F00	59,90
LT 500R QUADRACER	1987-89	71-195045	33410-09411	59,90
LTF 500 QUADRUNNER	1998-02	71-195069	33410-09F00	59,90
LTF 500 VINSON	2003-06	71-195069	33410-09F00	59,90
LTA 500 KING QUAD	2009-11	71-195069	33410-09F00	59,90
LTA 700 KING QUAD	2005-07	71-195069	33410-09F00	59,90
LTA 750 KING QUAD	2008-12	71-195069	33410-09F00	59,90

YAMAHA	vm	tuotenro	Korvaa alkup.nr.	hinta
YFM 50R RAPTOR	2004-06	71-195069	3KJ-82310-10-00	37,90
YFM 80 BADGER	1992-01	71-195069	3KJ-82310-10-00	37,90
YFM 80 RAPTOR	2002-06	71-195069	3KJ-82310-10-00	37,90
YFM 80 GRIZZLY	2005-06	71-195069	3KJ-82310-10-00	37,90
YFA BREEZE	1998-04	71-195069	3KJ-82310-10-00	37,90
YFZ 200 BLASTER	1997	71-195069	3KJ-82310-10-00	37,90
YFB 250 TIMBERWOLF	1992-98	71-195068	3GD-82310-10-00	37,90
YFM 250 BEAR TRACKER	1999-04	71-195069	3KJ-82310-10-00	37,90
YMF 350ER MOTO-4	1990-95	71-195068	3GD-82310-10-00	37,90
YFM 350 BIG BEAR	1989-97	71-195068	3GD-82310-10-00	37,90
YFM 350X WARRIOR	1989-01	71-195068	3GD-82310-10-00	37,90
YFM 350 BIG BEAR	1998-99	71-195069	3KJ-82310-10-00	37,90
RAPTOR 350	2005-13	71-195069	3KJ-82310-10-00	37,90
YFM 400FW KODIAK	1993-98	71-195068	3GD-82310-10-00	37,90
KODIAK 400	1999-06	71-195069	3KJ-82310-10-00	37,90
YFM 400 BIG BEAR	2000-03	71-195070	5FL-82310-00-00	37,90
YFM 400 BIG BEAR	2005-12	71-195070	5FU-82310-00-00	37,90
WOLVERINE 450	2006-09	71-195069	3KJ-82310-10-00	37,90
GRIZZLY 450	2009-14	71-195069	3KJ-82310-10-00	37,90
GRIZZLY 600	1998-01	71-195069	3KJ-82310-10-00	37,90
GRIZZLY 660	2002-08	71-195069	3KJ-82310-10-00	37,90
RAPTOR 660	2001-05	71-195069	3KJ-82310-10-00	37,90

YLEISMALLIT	tuotenro	Korvaa alkup.nr.	hinta
USEIMMAT KIINA MÖNKIJÖIHIN 6v & 12v CDI JÄRJESTELMÄÄN	71-01300-1		28,90
	71-01302		20,90

Reikäväli: 60mm



DV RACING PICS

ATV

LÄMPÖTILA-ANTURIT



71-01371

uutuus!

CAN-AM	
71-01371	13,50
Korvaa Alkup.nro.	278001016
Mitat:	19mm nut, overall length:61.2mm. 2pin.
Sopivuudet ATV	
2003-05	TRAXTER
2012-14	OUTLANDER 1000EFI
2013-14	OUTLANDER MAX 1000EFI LTD
2008-14	OUTLANDER 400 EFI, STD, XT
2008-14	OUTLANDER MAX 400 EFI, STD, XT
2007-13	OUTLANDER 500EFI STD, DPS & XT
2007-13	OUTLANDER MAX 500EFI STD, DPS & XT
2006-14	OUTLANDER 650EFI STD, DPS & XT
2006-14	OUTLANDER MAX 650EFI
2006-13	OUTLANDER 800R EFI, STD, DPS, XT & XT-P
2006-13	OUTLANDER MAX 800R EFI, DPS, XT & XT-P
2008-13	RENEGADE 500EFI STD
2007-13	RENEGADE 800R EFI STD & XXC
2012-14	RENEGADE STD, XXC, 1000 EFI
Sopivuudet UTV	
2011-14	COMMANDER 1000 STD, DPS, XT, XT-P
2011-14	COMMANDER 800 STD, DPS, XT
2013	MAVERICK



71-01365

uutuus!

KAWASAKI	
71-01365	19,90
Korvaa Alkup.nro.	21176-0009
Mitat:	17mm nut, m10 X pitch 1.25mm. Overall length:52.4mm.w/2pin.
Sopivuudet ATV	
2008-14	KFX450R
2008-14	BRUTE FORCE 750 4X4I (KVF750)
2012-14	BRUTE FORCE 750 4X4I EPS (KVF750)
Sopivuudet UTV	
2009-14	TERYX 750 4X4/TERYX 4 ALL OPTIONS



71-01368

uutuus!

YAMAHA	
71-01368	19,90
Korvaa Alkup.nro.	5KM-82560-00-00
Mitat:	14mm nut, overall length:50.8mm 1 pin.
Sopivuudet ATV	
2007-14	YFM450 GRIZZLY 450
2002-08	YFM660 GRIZZLY 660
2003-06	YFM450 KODIAK 450 4WD
2004-07	YXR660 RHINO 660
2007-10	YFM45 WOLVERINE 450



71-01359

uutuus!

uutuus!



71-01363



71-01362

uutuus!

HONDA	
71-01359	19,90
Korvaa Alkup.nro.	37870-RZA-007
Mitat:	17 mm nut, M10 x pitch 1.25, Length 52.1 mm, w/ o-ring
Sopivuudet	
2012-14	TRX500FE/FM/ FPE/FPM

YAMAHA	
71-01363	19,90
Korvaa Alkup.nro.	8CC-85790-01
Mitat:	19 mm, nut, M12xpitch 1.5 Overall length 59 mm, w/ 2 pin
Sopivuudet ATV	
2009-14	GRIZZLY 550 ALL OPTIONS
2007-13	GRIZZLY 700 ALL OPTIONS
2009-14	YFZ450R
2010-11	YFZ450X
Sopivuudet UTV	
2008-13	RHINO 700 ALL OPTIONS

POLARIS	
71-01362	19,90
Korvaa Alkup.nro.	3089892
Mitat:	19 mm, nut, length 56.6 mm w/ 2 pin.
Sopivuudet	
2011-13	SPORTSMAN 550
2010-14	SPORTSMAN 550 EPS/XP EPS
2011-14	SPORTSMAN FOREST 550
2011-14	SPORTSMAN FOREST TRACTOR 500
2008-09	SPORTSMAN TOURING 500 EFI
2008-09	SPORTSMAN TOURING 500 EFI QUAD
2010-14	SPORTSMAN TOURING 550 EPS
2006-09	SPORTSMAN X2 500 EFI
2010-14	SPORTSMAN X2 550
2014	SPORTSMAN X2 550 EPS
2009-10	SPORTSMAN XP 550
2013-14	SPORTSMAN XP 550 EPS/HD
2012	SPORTSMAN XP TOURING EPS 550



71-01364

uutuus!

POLARIS	
71-01364	19,90
Korvaa Alkup.nro.	4010644
Mitat:	19 mm, nut, M12xpitch 1.5 Overall length 60.9 mm, w/ 2 pin
Sopivuudet ATV	
2014	SPORTSMAN 570 EFI ALL OPTIONS
2014	SPORTSMAN TOURING 570 EFI
2004-08	SPORTSMAN 700 EFI ALL OPTIONS
2005-14	SPORTSMAN 800 EFI
2009-14	SPORTSMAN 800 EFI 6X6
2012-13	SPORTSMAN FOREST 800
2012-13	SPORTSMAN FOREST 800 6X6
2008-09	SPORTSMAN TOURING 800 EFI
2007-09	SPORTSMAN X2 800 EFI
2011	SPORTSMAN X2 850
2011-14	SPORTSMAN FOREST 850
2009-14	SPORTSMAN XP 850 ALL OPTIONS
2010-14	SPORTSMAN TOURING 850
2013-14	SCRAMBLER 850 HO/EPS HO
2014	SCRAMBLER XP 1000 HO EPS
2014	SPORTSMAN ACE
2014	RANGER 570 EFI
2014	RANGER CREW 570 EFI

Sopivuudet UTV	
2005-09	RANGER 4X4 700 EFI ALL OPTIONS
2006-09	RANGER 6X6 700 EFI
2010-14	RANGER 6X6 800
2013-14	RANGER 800
2010-14	RANGER 800 CREW
2014	RANGER 900 CREW ALL OPTIONS
2013-14	RANGER 900 XP ALL OPTIONS
2012	RANGER XP 800
2012-14	RZR 570
2008-14	RZR 800 ALL OPTIONS
2009-14	RZR S 800 EFI
2010-14	RZR 4 800
2011-14	RZR 900 ALL OPTIONS
2012-14	RZR 4 900
2014	RZR XP 1000



Vanteet ja renkaat



Talvitouotteet



Vinsit



Laukut ja tuulisuojat



Sähköosat



Jousitus ja voimansiirto



Pakoputket ja suutinsarjat



Ohjau



Rungon osat ja peitteet



Jarrupalat ja rattaat



Moottori



Variaattorin osat



Maatalous-tarvikkeet



Kärryt ja reet

ATV



HÄTÄKATKAISIJAT

Yamaha

Tuotenumero	Tuote	Hinta
71-01001	Hätäkatkaisija (Korvaa Alkup.nr. 8H8-82550-00/01)	14,30



71-01001

Yleismallit

Tuotenumero	Tuote	Hinta
71-01091	Hätäkatkaisija, yleismalli	30,50
81-197	Hätäkatkaisija, yleismalli	25,00
81-194	Hätäkatkaisija, yleismalli	27,00
81-117	Hätäkatkaisijan naru	10,20



71-01091



81-197



81-194



Vanteet ja renkaat



Talvituotteet



Vinssit



Laukut ja tuulisuojat



Sähköosat



Jousitus ja voimansiirto



Pakoputket ja suutinsarjat



Ohjaus



Rungon osat ja peitteet



Jarrupalat ja rattaat



Moottori



Variaattorin osat



Maatalous-tarvikkeet



Kärryt ja reet

VALONVAIHTAJAT

Yamaha/yleis

- Johtojen pituus 43cm

Tuotenumero	Tuote	Osh.
71-01510	Valonvaihtaja	27,50



Polaris

- Johtojen pituus 50cc

Tuotenumero	Tuote	Osh.
71-01511	Valonvaihtaja	45,50



Honda

- Ledivalolle
- Johtojen pituus 40cm

Tuotenumero	Tuote	Osh.
71-01512	Valonvaihtaja	43,00



Honda

- Painike tappokatkaisijalle
- Johtojen pituus 40cm

Tuotenumero	Tuote	Osh.
71-01513	Valonvaihtaja	48,50



VALOT

BRONCO
ATV COMPONENTS

Lisävalosarja

Valoaukko: 47mm,
poltin: H3 12V55W.

Tuotenro	Hinta
71-0077	29,00



Lisävalosarja

Valoaukko: 105mm, poltin H3
12V 55W

Tuotenro	Hinta
71-0078	49,00



LED-VALOT

BRONCO
ATV COMPONENTS



Led-työvalopari

6x3W, 4500candela
käyttölämpötila -40°C - +85°C
käyttöikä 50.000 h
30 % tehokkaampi poltin
ulkomitat L109/K73,5/S85 mm

Tuotenro	Hinta
71-01110	229,00



Led-valo 12x3W

12x3W, 9000candela
käyttölämpötila -40°C - +85°C
käyttöikä 50.000 h
30 % tehokkaampi poltin
ulkomitat L184/K73,5/S85 mm

Tuotenro	Hinta
71-01110-1	182,00



Led-valo 18x3W

18x3W, 13500candela
käyttölämpötila -40°C - +85°C
käyttöikä 50.000 h
30 % tehokkaampi poltin
ulkomitat L259/K73,5/S85 mm

Tuotenro	Hinta
71-01110-2	259,00



Led-valo 24x3W

24x3W, 18000candela
käyttölämpötila -40°C - +85°C
käyttöikä 50.000 h
30 % tehokkaampi poltin
ulkomitat L334/K73,5/S85 mm

Tuotenro	Hinta
71-01110-3	329,00



Vanteet ja renkaat



Talvituotteet



Vinssit



Laukut ja tuulisuojat



Sähköosat



Jousitus ja voimansiirto



Pakoputket ja suutinsarjat



Ohjaus



Rungon osat ja peitteet



Jarrupalat ja rattaat



Moottori



Variaattorin osat



Maatalous-tarvikkeet



Kärryt ja reet

ATV





Vanteet ja renkaat



Talvituotteet



Vinssit



Laukut ja tuulisuojat



Sähköosat



Jousitus ja voimansiirto



Pakoputket ja suutinsarjat



Ohjaus



Rungon osat ja peitteet



Jarrupalat ja ratat



Moottori



Variaattorin osat



Maatalous-tarvikkeet



Kärryt ja reet

strands

-lighting division

uutuus!

TYÖVALOT

uutuus!



strands
-lighting division

Led-minityövalo

- 10 W, LED, 10-30 V, 6000 K, 900 lumenia.
- Mitat: 66 x 66 x 65 mm. IP67. Työvalokuvio.

Tuoteno	Osh.
109-809010	56€



strands
-lighting division

Led-työvalo "mini"

- 10-30 V, 1200 lumenia.
- Mitat 84 x 84 x 38 mm. IP67.
- 5 x 3 W Epistar led-yksikkö, alumiinikoppa ja galvanoitu kiinnitysalku
- Yhtä paljon tai jopa enemmän valoa kuin vastaavissa isommissa työvaloissa.
- Pienen kokonsa ja muotonsa ansiosta helppo asentaa.

Tuoteno	Osh.
109-809002	32,50€



strands
-lighting division

Led-työvalo 15 W

- Led-työvalo, IP67, 1100 lumenia.
- 110 x 110 x 40 mm. 9-30 V. 5 x 3 W.

Tuoteno	Osh.
109-809015	28€



strands
-lighting division

Led-työvalo 18 W

- Pyöreä led-työvalo, IP67, 1400 lumenia. 115 x 115 x 40 mm. 9-30 V. 6 x 3 W.

Tuoteno	Osh.
109-809016	28€



strands
-lighting division

Led-työvalo hajottava

- 10-30 V, 48 W. 2880 lumenia. Mitat: 115x115x62 mm. IP67.

Tuoteno	Osh.
109-809017	89€



strands
-lighting division

Led-työvalo 18 W 6 led

- 10-30 V. 1080 lumenia. 160 x 47,5 x 63 mm. IP67. 1,4A@12V, 0,75A@24V. Epistar-led.

Tuoteno	Osh.
109-809026	49€

ATV

TYÖVALOT

uutuus!



strands
-lighting division

Led-työvalo 27 W leveä valokuvio

- 9-32 V. 1620 lumenia. Koppa alumiiniva-lua, PMMA-linsillä (akryyli). Epistar-led. CE, RoHS yhteeneväinen. IP67. Mitat 128 x 110 x 55 mm.

Tuotenumero	Osh.
109-809027	49€



strands
-lighting division

Kannettava työvalo

- Kahva. 15 W. Mitat KxLxS: 277 x 84 x 37 mm. 960 lumenia. Ladattava, sis. tupakan-sytytinpistokkeen ja 220 V laturin. Toimii täydellä akulla noin 4 h ja akun latautumi-nen tyhjästä täyteen kestää n. 4 h.

Tuotenumero	Osh.
109-TD90006	94€



strands
-lighting division

Kannettava työvalo

- Teho 15 W. Mitat K x L x S: 192,5 x 110 x 100 mm

Tuotenumero	Osh.
109-TD90005	96€

VALORAMPIT

uutuus!



strands
-lighting division

Led-työvaloramppi 6-led

- 30W. 10-30V. CREE-led 2700 Lumen. Mitat kiinnikkeineen: 276x75x69 mm. IP67. 2,4A@12V, 1,12A@24V. 6000K. Jalat säädettävissä leveyssuunnassa. Palkkimainen valokuvio.

Tuotenumero	Osh.
109-809005	158€



strands
-lighting division

Led-työvaloramppi 12-led

- 60W. 10-30V. CREE-led 5400 Lumen. Mitat kiinnikkeineen: 516x75x69 mm. IP67. 4,8A@12V, 2,24A@24V. 6000K. Jalat säädettävissä leveyssuunnassa. Palkkimainen valokuvio.

Tuotenumero	Osh.
109-809006	271€



strands
-lighting division

Kaareva led-valoramppi 120 W

- 120 W. 10-30 V. 3 W CREE LED. 8800 lumenia. 628 x 111 x 86,5 mm. IP67. Virrankulutus: 8,2A@12V - 4,1A@24V. EMC-sertifioitu.

Tuotenumero	Osh.
109-809101	323€



strands
-lighting division

Kaareva led-valoramppi 180 W

- 180 W. 10-30 V. 3 W CREE LED. 13200 lumenia. 883 x 111 x 86,5 mm. IP67. Virrankulutus: 12A@12V - 5,8A@24V. EMC-sertifioitu.

Tuotenumero	Osh.
109-809102	439€

Kolme valotoimintoa: 100 % teho (900 lumenia), 30 % teho ja SOS-välkky. Ladattava, sisältää tupakan-sytytinli-itännän sekä 230 V verkkovirtalaturin. Magneettijalka antaa monia käyttö-mahdollisuuksia (esim. renkaanvaihto pimeässä). Toimii täydellä akulla n. 4 tuntia. Akun lataus tyhjästä täyteen n. 4 tuntia.



Vanteet ja renkaat



Talvituotteet



Vinsit



Laukut ja tuulisuojat



Sähköosat



Jousitus ja voimansiirto



Pakoputket ja suutinsarjat



Ohjaus



Rungon osat ja peitteet



Jarrupalat ja rattaat



Moottori



Variaattorin osat



Maatalous-tarvikkeet



Kärryt ja reet

ATV



LISÄVALOT

uutuus!



Vanteet ja renkaat



Talvituotteet



Vinssit



Laukut ja tuulisuojat



Sähköosat



Jousitus ja voimansiirto



Pakoputket ja suutinsarjat



Ohjaus



Rungon osat ja peitteet



Jarrupalat ja rattaat



Moottori



Variaattorin osat



Maatalous-tarvikkeet



Kärryt ja reet



Ljusdal Halogen

strands
-lighting division

- FF-heijastinteknologia (Free-form).
- Vahvistettu iskunkestävä muovikuori. Kar-kaistu lasi.
- Kiinnitysalka rosteria.
- H7 halogeenipolttimo + T10 parkkipolttimo (eivät sisälly).
- 12 tai 24 V.
- Kivisuoja saatavissa lisävarusteena.
- Ref. 25. Syvyys vain 122 mm. Halkaisija 225 mm.

Tuotenro		Osh.
109-270771	Sininen lasi	52€
109-270772	Kirkas lasi	47,50€



Sala led 7"

strands
-lighting division

- 7". Kaukovoalo. 10-30 V. 40 W.
- Kirkas linssi. IP67.
- L x K x S: 182 x 188 x 85 mm. Ref. 12,5.
- Lisävalo: 4 kpl 10 W Cree LED.
- Parkkivalo: 8 kpl 0,2 W LED.
- Kolmen vuoden takuu.
- E-hyväksytty.

Tuotenro	Osh.
109-270914	284,50€



Sveg led 9"

strands
-lighting division

- 9". Kaukovoalo. 10-30 V. 60 W. Kirkas linssi. IP67.
- L x K x S: 232 x 239 x 79. Ref. 17,5.
- Lisävalo: 6 kpl 10 W Cree LED.
- Parkkivalo: 12 kpl 0,2 W LED.
- Kolmen vuoden takuu.
- E-hyväksytty.

Tuotenro	Osh.
109-270913	361€



Narvik Xenon

strands
-lighting division

- Modernilla free-form heijastimella, karkaistulla lasilla ja kestäväällä muovikopalla varustettu.
- Polttimo D15 xenon (35 W). Integroitu ballasti, multivolt 9-32 V.
- Musta kehys, vaihdettavissa.
- Läpinäkyvä kivisuoja sisältyy hintaan.
- Halkaisija n. 224 mm.

Tuotenro	Osh.
109-270770	296€



Lisävalon pystytuki

strands
-lighting division

- Pari, 200mm.

Tuotenro	Osh.
109-270422	4,80€



strands
-lighting division

Teline lisävaloille 2 kiinnityspisteellä

Tuotenro	Osh.
109-270401	22,50€



strands
-lighting division

Teline lisävaloille 3 kiinnityspisteellä

Tuotenro	Osh.
109-270402	21,50€



strands
-lighting division

Johtosarja 2 lisävalolle

Tuotenro	Osh.
109-270411	12,60€

ATV



strands
-lighting division

Pyörivä ja välähtävä led-majakka

- ECE R65- hyväksytyt pyörivät led-valot
- Kolme eri valokuvioita: pyörivä ja kaksi erilaista välähtävää valokuvioita.
- Toimivat 12-24V.
- 3-pultt. tasapohja
- kork. 183 suurin halk. 142 mm.

Tuotenro	Osh.
109-809056	118€



strands
-lighting division

Pyörivä ja välähtävä led-majakka

- ECE R65- hyväksytyt pyörivät led-valot
- Kolme eri valokuvioita: pyörivä ja kaksi erilaista välähtävää valokuvioita.
- Toimivat 12-24V.
- Tappikiinnitys
- Kork. 235 suurin halk. 128 mm.

Tuotenro	Osh.
109-809057	118€



strands
-lighting division

Led-varoitus/merkkivalo pun. "Kiekko"

- 9 eri valo-ohjelmaa. Valokantama jopa 800m. Vesitiivis.
- Vaihdeettava litiumparisto (CR123A) kestää jopa 100 tuntia.
- Mitat n. 105x35 mm.
- Helppo magneettikiinnitys.

Tuotenro	Osh.
109-TD90000	24€



strands
-lighting division

Led-varoitus/välähdysvalo "kiekko", 6 kpl pakkaus, kantolaukulla, ladattava

- 9 eri välähdyskuviota. Valokantama jopa 800 m.
- Vesitiivis. Lataus tupakansytyttimestä tai verkkovirralla.
- Kantolaukku toimii myös lataustelakkana, missä kiekot latautuvat toisistaan riippumatta, 1-6 kpl kerralla.
- Mukaan sisältyvät laturit sekä 230 V verkkovirralla että 12-24V virranulosotolle.

Tuotenro	Osh.
109-TD90002	159€

strands
-lighting division

Tasovilkku 3led 12-24V oranssi

- ECE R65 -hyväksytty. 50c m johto.
- Useampia yksiköitä voidaan synkronisoida.
- 11 välähdyskuviota. 36 x 100 x 40 mm.

Tuotenro	Osh.
109-850155-A	78€



strands
-lighting division

Tasovilkku 4led 12-24V oranssi

- ECE R65 -hyväksytty. 50 cm johto.
- Useampia yksiköitä voidaan synkronisoida.
- 18 välähdyskuviota. 36 x 120 x 40 mm.

Tuotenro	Osh.
109-850165-A	85,55€



Vanteet ja renkaat



Talvituotteet



Vinsit



Laukut ja tuulisuojat



Sähköosat



Jousitus ja voimansiirto



Pakoputket ja suutinsarjat



Ohjaus



Rungon osat ja peitteet



Jarrupalat ja rattaat



Moottori



Variaattorin osat



Maatalous-tarvikkeet



Kärryt ja reet

ATV





TAKALYHDYN LASIT



Arctic cat

Tuote	Tuotenumero	Hinta
Takalyhdynlasi	71-01050	15,20

Korvaa alkup.n.r. 0409-007

Sopivuudet	Vm
Kaikki mallit paitsi 50cc,90cc	-2005

Arctic cat

Tuote	Tuotenumero	Hinta
Takalyhdynlasi	81-280337	32,00

Korvaa alkup.n.r. 0509-025

Sopivuudet	Vm
400	2005-09
400 DVX	2004-08
500	2005-09
550 H1	2009
650	2005-09
700 H1	2006-10
1000	2008-10



Bombardier

Tuote	Tuotenumero	Hinta
Takalyhdynlasi	71-01050	15,20

(Korvaa Alkup.n.r. 710-000-055)

Sopivuudet	Vm
DS 650	2000-05
DS 650 BAJA	2001-05
DS 650 X	2004-07
QUEST 500	2002-04
QUEST 650,XT	2002-04
OUTLANDER 330	2004
OUTLANDER 400	2003-04
OUTLANDER 500	2007
TRAXXTER,kaikki mallit	1999-05
RALLY	2003-04



Honda

Tuote	Tuotenumero	Hinta
Takalyhdynlasi	71-01051	19,00

(Korvaa Alkup.n.r.33710-HB3-771)

Sopivuudet	Vm
TRX 200 FOUR TRAX	1990-91
TRX 200 D FOUR TRAX II	1991-96
TRX 200 SX	1987-88
TRX 250 RECON	1997-01
TRX 300 FOUR TRAX	1988-96
TRX 300 FOUR TRAX	1997-00
TRX 300 FW FOUR TRAX	1988-96
TRX 300 FW FOUR TRAX	1997-00
TRX 350 D	1987-89
TRX 350 FOUR TRAX	1986-94
TRX 350 FW FOUR TRAX	1986-94
TRX 400 FW FOUR TRAX	1995-01
TRX 450 S,ES,FE,FM	1998-03



Kawasaki

Tuote	Tuotenumero	Hinta
Takalyhdynlasi	71-01052	15,00

(Korvaa Alkup.n.r. 23026-4003/23026-1239)

Sopivuudet	Vm
KEF 300 LAKOTA A	1995-00
KEF 300 LAKOTA B	2001-03
KLF 110 MOJAVE	1987-88
KLF 250 BAYOU	1988-10
KLF 300 BAYOU C	1989-04
KLF 400 BAYOU B	1993-99
KLT 110 A	
KLT 160 A	1985
KLT 185 A	1986-87
KLT 250 A	1983
KLT 250 PRAIRIE	1983-85
KLT 250 POLICE	1984
KSF 250 MOJAVE	1987-00
KVF 300 PRAIRIE	1999-02
KVF 360 PRAIRIE	2003-10
KVF 400 PRAIRIE A	1997-98
KVF 400 PRAIRIE B	1998
KVF 400 PRAIRIE C	1999-02
KVF 400 PRAIRIE D	1999-02
KRF 750 TERRYX	2008-10
KXF250	1987-88
KXT 250	1984-87

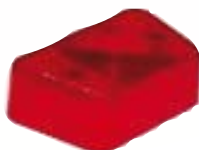

Polaris

Tuote	Tuotenumero	Hinta
Takalyhdynlasi	81-089	13,60

(Korvaa Alkup.n.r.4032046/4032030)

Sopivuudet	Vm
Kaikki mallit	1985-06



Suzuki

Tuote	Tuotenumero	Hinta
Takalyhdynlasi	71-01054	13,60

(Korvaa Alkup.n.r. 35712-18A32)

Sopivuudet	Vm
LT 160	1989-01
LT 230	1987-93
LT 230 GE	1985-86
LT 230 GEF	1985
LT 230 S	1985-88
LT 250 R	1985-92
LT 250 S	1989-90
LT 300 E	1987-88
LT 500 R	1987-89
LTA 500 F	2000-01
LT-F 160	1993-01
LT-F 230	1986-87
LT-F 250	1988-91
LT-F 250 4WD	1987-01
LT-F 250 F	1999-02
LT-F 300	1987-89
LT-F 300	1991-98
LT-F 300 KING QUAD	1999-02
LT-F 500 QUAD RUNNER	1998-02

TAKALYHDYT



Arctic cat

Tuote	Tuotenumero	Hinta
Takalyhty	81-018	39,00

Korvaa alkup.n.r. 0509-029

Sopivuudet	Vm
400	2005-09
400 DVX	2004-08
500	2005-09
550 H1	2009
650	2005-09
700 H1	2006-10
1000	2008-10



Honda

Tuote	Tuotenumero	Hinta
Takalyhty	71-192254	29,30

Korvaa alkup.n.r. 33700-HA7-671

Sopivuudet	Vm
TRX 350	1986-89



Yamaha

Tuote	Tuotenumero	Osh.
Takalyhty	81-01108	85,00

(Korvaa Alkup.n.r. 5PW-84710-00-00)

Sopivuudet	VM
GRIZZLY 550	2009-13
GRIZZLY 660	2002-06
GRIZZLY 700	2007-13



Vanteet ja renkaat



Talvituotteet



Vinssit



Laukut ja tuulisuojat



Sähköosat



Jousitus ja voimansiirto



Pakoputket ja suutinsarjat



Ohjaus



Rungon osat ja peitteet



Jarrupalat ja rattaat



Moottori



Variaattorin osat



Maatalous-tarvikkeet



Kärryt ja reet



KAASUISKUNVAIMENTAJAT

Kaikki Bronco-iskunvaimentimet sisältävät jouset.
10% jäykemmät kuin alkuperäiset.

ARCTIC CAT	VM.	ETEEN	TAAKSE
400	2009-13	78-04320	78-04420
450	2010-13	78-04320	78-04420
500	2009-14	78-04320	78-04420
550	2009-14	78-04320	78-04420
650	2009-11	78-04320	78-04420
700	2008-14	78-04320	78-04420
1000	2008-14	78-04320	78-04420
THUNDER CAT	2008-10	78-04320	78-04420
CAN-AM	VM.	ETEEN	TAAKSE
330	2005		78-04414
400	2005-14		78-04414
HONDA	VM.	ETEEN	TAAKSE
TRX300FW 4X4	1993-97	78-04205	78-04255
TRX300FW 4X4	1998-00	78-04206	78-04256
TRX350 TM/FE/TE/FM S/ES	2000-03	78-04203	78-04253
TRX350 TM/FE/TE/FM RANCHER S/ES 4X4	2004-06	78-04203	78-04254
TRX400FW FOREMAN	1995-03	78-04202	78-04252
TRX 420FA/FE/TE/TM	2007-13	78-04209	78-04259
TRX450E/ES FOREMAN	1998-04	78-04207	78-04257
TRX 500	2001-14	78-04322	78-04422
TRX 680 RINCON	2006-14	78-04208	78-04258
KAWASAKI	VM.	ETEEN	TAAKSE
KVF650 Brute Force	2009-14	78-04307	78-04407
KVF750 Brute Force	2005-12	78-04307	78-04407
POLARIS	VM.	ETEEN	TAAKSE
250,300,350,400	1988-94	78-04300	
335,425,500,600,700	1995-08	78-04400	
330,400,500,570,800 SPORTSMAN	2010-14	78-04315	78-04415
400,500 SPORTSMAN	1999-01	78-04400	78-04401
400,500 SPORTSMAN	2001-06	78-04400	78-04301
600,700 SPORTSMAN	2001-06	78-04400	78-04301
550,850 XP SPORTSMAN	2009-14	78-04316	78-04416
SUZUKI	VM.	ETEEN	TAAKSE
LT-F 250,300	1987-02	78-04311	78-04411
LT-A 700X KING QUAD	2005-07	78-04308	78-04408
LT-A 750X	2008-12	78-04308	78-04408
YAMAHA	VM.	ETEEN	TAAKSE
YFM350FW BIG BEAR	1989-96	78-04302	78-04402
YFM 350 GRIZZLY	2007-10	78-04318	78-04417
YFM 350 GRIZZLY IRS	2007-10	78-04318	78-04418
YFM400FW KODIAK	1993-00	78-04302	78-04402
KODIAK 400/450	2003-04	78-04303	78-04403
KODIAK 400	2005	78-04303	78-04403
BIG BEAR 400	2000-06	78-04306	78-04406
YFM 450 GRIZZLY	2008-10	78-04318	78-04418
YFM 450 GRIZZLY	2011-14	78-04319	78-04418
GRIZZLY 550	2009-14	78-04305	78-04405
GRIZZLY 660	2002-08	78-04304	78-04404
GRIZZLY 700	2007-14	78-04305	78-04405



Mittataulukko

Tuoteno	Korvaa alkup.nro	Max Pituus	Ala silm.	Ylä silm.	Hinta
78-04203	51400-HN5-671 51400-HN4-671	345	10,15	10,15	114,00
78-04205	51400-HC5-970	332	10,2	10,2	119,00
78-04206	51400-HM4-A10 51400-HM5-A10	302	10,2	10,2	114,00
78-04207	51400-HN0-671 51400-HN0-A01	364	10,2	10,2	132,00
78-04208	51400-HN8-003	389	10,15	21	127,00
78-04209	51400-HP4-601	367	10,1	10,1	127,00
78-04252	52400-HM7-003	347	10,15	16	112,00
78-04253	52400-HN5-671 52400-HN4-671	395	10,2	10,2	115,00
78-04254	52400-HN4-M61 52400-HN5-N01 52400-HN5-970	396	10,2	10,2	116,00
78-04255	52400-HM5-851	362	10,2	10,2	115,00
78-04256	52400-HM5-A10	365	10,2	10,2	121,00
78-04257	52400-HN0-671 52400-HN0-A01	390	10,2	15,8	121,00
78-04258	52400-HN8-003	463	18	23	122,00
78-04259	52400-HP4-601	423	10,1	10,1	122,00
78-04300	7041451,7041304,7041211	486			130,00
78-04301	7041959	408	9,8	9,8	172,00
78-04302	3HN-23350-00-33	310	10,2	10,2	102,00
78-04303	5ND-F3350-01-00	362	10,1	10,1	118,00
78-04304	5KM-23350-20-00 5KM-23350-00-00	366	10,2	10,2	126,00
78-04305	3B4-23350-01-00 3B4-23350-00-00	358	10,2	10,2	126,00
78-04306	5FU-F3350-10-00	388	10	10	110,00
78-04307	45014-0203	360	10,1	10,1	127,00
78-04308	52100-31G00-019 52100-31G10-019 52100-31G00-YU8	373	10,1	10,1	116,00
78-04311	52100-19B81-019	255	10	20	105,00
78-04315	7041762	561			144,00
78-04316	7043464	395	10,1	10,1	141,00
78-04318	5UH-F3350-01-00	360	10	10	105,00
78-04319	1CT-F3350-00-00	347	10	10	105,00
78-04320	0403-209	405	10,1	10,1	134,00
78-04322	51400-HN2-003 51400-HN2-A22 51400-HN2-A61 51400-HN2-B41	395	10,1	10,1	113,00
78-04400	7041762	480			160,00
78-04401	7041770	408	9,8	9,8	176,00
78-04402	3HN-22210-30-33	342	12,2	12,2	123,00
78-04403	5ND-F2210-10-00, 5ND-F2210-00-00	445	12,2	10,2	149,00
78-04404	5KM-22210-20-00 5KM-22210-20-00	371	10,2	10,2	136,00
78-04405	3B4-22210-00-00 3B4-22210-01-00	408	10,2	10,2	147,00
78-04406	5FU-F2210-10-00	398	12	12	143,00
78-04407	45014-0204	350	10,2	10,2	116,00
78-04408	62100-31G00-019 62100-31G10-019 62100-31G00-YU8	365	10,1	10,1	134,00
78-04414	706000391	410	9,8	9,8	127,00
78-04415	7043100	407	9,8	9,8	147,00
78-04416	7043463	503	10,1	10,1	178,00
78-04417	5UH-F2210-01-00	448	12	12	121,00
78-04418	175-F2210-00-00 1CT-F2210-00-00	375	10	10	121,00
78-04420	0404-158/274	390	16	10,1	143,00
78-04422	52400-HN2-003 52400-HN2-A22 52400-HN2-A61 52400-HN2-B41	416	10,1	15,6	109,00



Vanteet ja renkaat



Talvituotteet



Vinsit



Laukut ja tuulisuojat



Sähköosat



Jousitus ja voimansiirto



Pakoputket ja suutinsarjat



Ohjaus



Rungon osat ja peitteet



Jarrupalat ja rattaat



Moottori



Variaattorin osat



Maatalous-tarvikkeet



Kärryt ja reet





Vanteet ja renkaat



Talvituuhteet



Vinssit



Laukut ja tuulisuojat



Sähköosat



Jousitus ja voimansiirto



Pakoputket ja suutinsarjat



Ohjaus



Rungon osat ja peitteet



Jarrupalat ja rattaat



Moottori



Variaattorin osat



Maatalous-tarvikkeet



Kärkyt ja reet

ATV



ISKUN-VAIMENTIMET



DSC

(Dual Speed Compression, puristusvaimennus)

DSC:lla saat säädettyä iskunvaimentajan nopean ja hitaan puristusvaimennuksen. 26 eri asentoa/klikkiä nopeassa sekä hitaassa vaimennuksessa.



DSC

DSC

(Dual Speed Compression, puristusvaimennus)

DSC:lla saat säädettyä iskunvaimentajan nopean ja hitaan puristusvaimennuksen. 26 eri asentoa/klikkiä nopeassa sekä hitaassa vaimennuksessa.

Spring Preload

(jousen esijännitys)

Säätämällä esijännitystä saat säädettyä ajokorkeuden ja optimoitua iskunvaimentajan eri painoisille kuskeille.

Huom. ATV Podium X toimitetaan aina Medium jousella, Soft ja Hard löytyy myös saatavilla.

Air Spring

(ilmajousi)

Ilmajousen ansiosta iskunvaimentimessa on progressiivisempi jousisuhde, se on helpompi säätää ja se on paljon kevyempi verrattuna perinteiseen "coil over" iskariin.

Evol

(Extra Volume Air Chamber)

Yhdistettynä Ilmajousen kanssa, lisä-ilmakammion (evol) tehtävänä on vaimentaa iskua jousikäyrän lopussa välttääkseen pohjaamista.

Rebound

(paluuvaimennus/vetovaimennus)

14 eri asentoa/klikkiä. Vastapäivään: nopeampi paluuvaimennus. Myötäpäivään: hitaampi paluuvaimennus.

Rebound

(paluuvaimennus/vetovaimennus)

14 eri asentoa/klikkiä. Vastapäivään: nopeampi paluuvaimennus. Myötäpäivään: hitaampi paluuvaimennus.

GENUINE KASHIMA COAT



Float 3 Evol RC2

Voittaaksesi kilpailuissa kalustosi täytyy toimia täydellisesti. Float 3 Evol RC2 on kehitetty erityisesti kilparatojen vaativiin olosuhteisiin. Ylivoimaisesti markkinoiden suorituskykyisin ja luotettavin iskunvaimennin. Nyt Kashima Coat -pinnoite vakiona!

Podium RC2

Podium RC2 on mestarin valinta. Säätämällä DSC:n, Paluuvaimennuksen ja Esijännityksen saat Podium RC2:n optimoitua joka lähtöön, on kyseessä sitten painava kuski tai kivi kova crossi rata.

Iskunvaimentimet: FLOAT 3 EVOL RC2



- Crossimönkijän etuisarit
- Myydään pareittain.
- Reservoir: Piggyback
- DSC (Dual Speed Compression): Nopea ja hidas puristusvaimennus
- Rebound: Yes
- Jouset: Tupla-ilmajouset



Hinta 1699€ / pari
(Chad Wiener Series 1999€ / pari)

Malli	Vuosimalli	Spec	Tuotenumero	Ilma paine säädöt (Main/Evol)		
				-65kg	65-90kg	90kg-
CAN-AM						
DS 450	2008-14	ATV 4 Play (+1 5/8") LT MX	974-830-24-089	30 / 140	35 / 150	40 / 160
DS 450	2008-14	Holz (+2")	974-830-24-077	30 / 140	35 / 150	40 / 160
DS 450	2008-14	JB Racing	974-830-24-095	30 / 140	35 / 150	40 / 160
DS 450	2008-14	Lonestar (+1.5") LT DC-4 MX	974-830-24-089	30 / 140	35 / 150	40 / 160
DS 450	2008-14	Stock A-arms XC model	974-830-24-063	30 / 140	35 / 150	40 / 160
DS 450	2008-14	Stock A-arms MX model	974-830-24-095	30 / 140	35 / 150	40 / 160
DS 450	2008-14	Walsh LT MX	974-830-24-095	30 / 140	35 / 150	40 / 160
DS 450	2008-14	Walsh (+1") XC	974-830-24-077	30 / 140	35 / 150	40 / 160
HONDA						
TRX 450R	2004-14	Alba Action LT (+2") A-Arms	974-830-24-001	38 / 120	42 / 140	45 / 150
TRX 450R	2004-14	ATV Four-Play MGC (Max Ground Clearance) (+3.25") "Gen 2" A-Arms	974-830-24-019	31 / 112	35 / 126	39 / 141
TRX 450R	2004-14	ATV Four-Play MGC (Max Ground Clearance) (+2.5") MX LT A-Arms	974-830-24-003	37 / 115	41 / 130	45 / 145
TRX 450R	2004-14	ATV Four-Play MGC (Max Ground Clearance) (+1") XC LT A-Arms	974-830-24-027	37 / 115	41 / 130	45 / 145
TRX 450R	2004-14	Dab Racing (+3") A-Arms	974-830-24-001	38 / 120	42 / 140	45 / 150
TRX 450R	2004-14	Denton (+3") A-Arms	974-830-24-001	38 / 120	42 / 140	45 / 150
TRX 450R	2004-14	Fireball MX (+3") A-Arms	974-830-24-001	38 / 120	42 / 140	45 / 150
TRX 450R	2004-14	Gibson MX (+3") A-Arms	974-830-24-001	38 / 120	42 / 140	45 / 150
TRX 450R	2004-14	Houser Pro Series LT MX Slicast (+2 1/4") A-Arms	974-830-24-003	30 / 160	35 / 160	40 / 160
TRX 450R	2004-14	Houser XC RT (+1") A-Arms	974-830-24-011	29 / 105	33 / 118	37 / 133
TRX 450R	2004-14	Houser Pro Series LT XC Slicast (+1") A-Arms	974-830-24-047	30 / 140	35 / 150	40 / 160
TRX 450R	2004-14	Hy-Tech ATV (+3") A-Arms	974-830-24-001	38 / 120	42 / 140	45 / 150
TRX 450R	2004-14	Inland ATV (+3") A-Arms	974-830-24-001	38 / 120	42 / 140	45 / 150
TRX 450R	2004-14	Janssen MX (+3") A-Arms	974-830-24-001	38 / 120	42 / 140	45 / 150
TRX 450R	2004-14	JB Racing MX (+2.375") A-Arms	974-830-24-005	37 / 115	41 / 130	45 / 145
TRX 450R	2004-14	JD Performance LT MX (+2", +3") A-Arms	974-830-24-005	37 / 115	41 / 130	45 / 145
TRX 450R	2004-14	JRD LT MX A-Arms	974-830-24-011	40 / 130	45 / 140	50 / 145
TRX 450R	2004-14	KBR (+3") A-Arms	974-830-24-001	38 / 120	42 / 140	45 / 150
TRX 450R	2004-14	Laeger's MX (+2") A-Arms	974-830-24-005	37 / 115	41 / 130	45 / 145
TRX 450R	2004-14	Laeger's Pro-Traxx MX (+2") A-Arms	974-830-24-005	37 / 115	41 / 130	45 / 145
TRX 450R	2004-14	Laeger's XC (+0.5") A-Arms	974-830-24-015	29 / 105	33 / 118	37 / 133
TRX 450R	2004-14	Lonestar DC-4 MX (+2") A-Arms	974-830-24-003	37 / 115	41 / 130	45 / 145
TRX 450R	2004-14	OMI MX (+2.5") A-Arms	974-830-24-047	45 / 160	50 / 180	55 / 200
TRX 450R	2004-14	Phil Tomlin Racing (+3") A-Arms	974-830-24-001	38 / 120	42 / 140	45 / 150
TRX 450R	2004-14	Quad Briel (+3") A-Arms	974-830-24-001	38 / 120	42 / 140	45 / 150
TRX 450R	2004-14	Sandragon (+3") A-Arms	974-830-24-001	38 / 120	42 / 140	45 / 150
TRX 450R	2004-14	Six5 Designs MX A-arms	974-830-24-019	30 / 116	35 / 126	40 / 136
TRX 450R	2004-14	Stock Shock Mount (+2") A-Arm (All MFGs)	974-830-24-013	32 / 130	35 / 135	40 / 150
TRX 450R	2004-14	Stock Shock Mount (Stock) A-Arms	974-830-24-013	30 / 120	32 / 130	35 / 140
TRX 450R	2004-14	Teixeira MX (+3") LT A-Arms	974-830-24-019	31 / 112	35 / 126	39 / 141
TRX 450R	2004-14	Walsh MX (+2.5") A-Arms	974-830-24-003	31 / 112	35 / 126	39 / 141
TRX 450R	2004-14	Walsh MX (+3") A-Arms	974-830-24-003	31 / 112	35 / 126	39 / 141
TRX 450R	2004-14	Walsh MX FLOW (+3") A-Arms	974-830-24-045	31 / 112	35 / 126	39 / 141
TRX 450R	2004-14	Wicked ATV (+3") A-Arms	974-830-24-001	38 / 120	42 / 140	45 / 150
TRX 700XX	2008-14	Roll Design A-Arms	974-830-24-061	40 / 175	45 / 200	50 / 225
TRX 700XX	2008-14	Stock Shock Mount (Stock) A-Arms	974-830-24-013	45 / 150	50 / 170	55 / 200
TRX 700XX	2008-14	Teixeira Tech (+1.25") A-Arms	974-830-24-015	30 / 140	35 / 150	40 / 160
KAWASAKI						
KFX 450	2007-14	ARS FX LT MX	974-830-24-077	30 / 140	35 / 150	40 / 160
KFX 450	2007-14	Gibson LT MX	974-830-24-001	35 / 140	40 / 150	50 / 160
KFX 450	2007-14	Houser Pro Series (+2) MGC LT MX A-Arms	974-830-24-067	30 / 150	35 / 150	40 / 160
KFX 450	2007-14	JB Racing (+2") MX A-Arms	974-830-24-019	31 / 112	35 / 126	39 / 141
KFX 450	2007-14	Laeger's (+2") MX A-Arms	974-830-24-019	31 / 112	35 / 126	39 / 141
KFX 450	2007-14	Lonestar (+2") LT MX	974-830-24-061	30 / 140	35 / 150	40 / 160
KFX 450	2007-14	Lonestar DC-4 MX A-Arms	974-830-24-021	30 / 140	35 / 150	40 / 160
KFX 450	2007-14	Lonestar DC Pro A-Arms	974-830-24-021	30 / 140	35 / 150	40 / 160
KFX 450	2007-14	Stock Shock Mount (+2") A-Arm (All MFGs)	974-830-24-013	40 / 150	45 / 160	50 / 180
KFX 450	2007-14	Stock Shock Mount (Stock) A-Arms	974-830-24-013	40 / 150	45 / 160	50 / 180



Vanteet ja renkaat



Talvituet



Vinsit



Laukut ja tuulisuojat



Sähköosat



Jousitus ja voimansiirto



Pakoputket ja suutinsarjat



Ohjaus



Rungon osat ja peitteet



Jarrupalat ja rattaat



Moottori



Variaattorin osat



Maatalous-tarvikkeet



Kärryt ja reet

ATV



Iskunvaimentimet:

FLOAT 3 EVOL RC2 JATKUU



Ilma paine säädöt (Main/Evol)

Malli	Vuosimalli	Spec	Tuotenumero	Ilma paine säädöt (Main/Evol)		
				-65kg	65-90kg	90kg-
KAWASAKI						
KFX 450	2007-14	Walsh Flow (+2") LT MX	830-24-061	30 / 140	25 / 150	40 / 160
KTM						
450, 505, 525 SX	2008-14	Stock SX A-Arms	974-830-24-093	25 / 180	25 / 200	30 / 220
POLARIS						
Outlaw 450, 525	2007-14	Dragonfire LT	974-830-24-011	30 / 140	35 / 150	40 / 160
Outlaw 450, 525	2007-14	Lonestar Racing (+2") LT MX	974-830-24-075	35 / 150	40 / 175	45 / 200
Outlaw 450, 525	2007-14	Rath Racing MX	974-830-24-063	30 / 140	35 / 145	40 / 155
Outlaw IRS 500, 525	2007-14	Stock Shock Mount (Stock) A-Arms (these shocks are 1" shorter than stock)	974-830-24-013	45 / 160	50 / 170	55 / 190
Outlaw 525 S	2007-14	Stock Shock Mount (Stock) A-Arms (these shocks are 1" shorter than stock)	974-830-24-013	45 / 160	50 / 170	55 / 190
Outlaw 450 MX	2007-14	Stock Shock Mount (Stock) A-Arms (these shocks are 1" shorter than stock)	974-830-24-013	45 / 160	50 / 170	55 / 190
SUZUKI						
LtZ400	2003-08	Stock Shock Mount (Stock) A-Arms	974-830-24-013	30 / 120	32 / 130	35 / 140
LtR450	2006-14	Alba Action LT (+0.5") A-Arms	974-830-24-011	33 / 120	38 / 140	42 / 145
LtR450	2006-14	ATV Four-Play Max Ground Clearance (+0.5") Std Travel MX A-Arms	974-830-24-023	40 / 140	42 / 160	45 / 180
LtR450	2006-14	ATV Four-Play Max Ground Clearance (-1 1/16") XC A-Arms	974-830-24-023	40 / 140	42 / 160	45 / 180
LtR450	2006-14	ATV Four-Play Max Ground Clearance (+0.5") Long Travel MX A-Arms	974-830-24-033	38 / 119	42 / 133	46 / 148
LtR450	2006-14	Dab Racing (+0.5") A-Arms	974-830-24-011	33 / 120	38 / 140	42 / 145
LtR450	2006-14	Denton (+0.5") A-Arms	974-830-24-011	33 / 120	38 / 140	42 / 145
LtR450	2006-14	Fireball Racing (+0.5") A-Arms	974-830-24-011	33 / 120	38 / 140	42 / 145
LtR450	2006-14	Herrmann (+1/4) A-Arms	974-830-24-021	45 / 195	50 / 210	55 / 225
LtR450	2006-14	Houser (+0") MX LT for Sli-Cast, Tric-Trac, Standard Mount A-Arms	974-830-24-049	45 / 195	50 / 210	55 / 225
LtR450	2006-14	Houser Pro Series (+0) MGC MX A-Arms	974-830-24-015	35 / 150	40 / 150	45 / 160
LtR450	2006-14	Hy-Tech ATV (+0.5") A-Arms	974-830-24-011	33 / 120	38 / 140	42 / 145
LtR450	2006-14	Inland ATV (+0.5") A-Arms	974-830-24-011	33 / 120	38 / 140	42 / 145
LtR450	2006-14	Janssen MX (+0.5") A-Arms	974-830-24-011	33 / 120	38 / 140	42 / 145
LtR450	2006-14	KBR (+0.5") A-Arms	974-830-24-011	33 / 120	38 / 140	42 / 145
LtR450	2006-14	KOQ LT MX (+0.5") A-Arms	974-830-24-021	45 / 195	50 / 210	55 / 225
LtR450	2006-14	Laeger (+0") LT MX A-Arms	974-830-24-027	37 / 115	41 / 130	45 / 145
LtR450	2006-14	Lonestar DC-4 (+1/2") MX A-Arms	974-830-24-025	32 / 115	36 / 130	40 / 145
LtR450	2006-14	Lonestar DC-4 XC A-Arms	974-830-24-033	38 / 119	42 / 133	46 / 148
LtR450	2006-14	Lonestar DC Pro A-Arms	974-830-24-021	40 / 190	45 / 200	50 / 210
LtR450	2006-14	Phil Tomlin Racing (+0.5") A-Arms	974-830-24-011	33 / 120	38 / 140	42 / 145
LtR450	2006-14	Quad Briel (+0.5") A-Arms	974-830-24-011	33 / 120	38 / 140	42 / 145
LtR450	2006-14	Roll Design (+1") A-Arms	974-830-24-027	37 / 115	41 / 130	45 / 145
LtR450	2006-14	Sandragon (+0.5") A-Arms	974-830-24-011	33 / 120	38 / 140	42 / 145
LtR450	2006-14	Stock Shock Mount (Stock) A-Arms	974-830-24-023	40 / 140	42 / 160	45 / 180
LtR450	2006-14	Walsh LT MX (+0.5") A-Arms	974-830-24-021	45 / 195	50 / 210	55 / 225
LtR450	2006-14	Walsh LT MX FLOW (+0.75") A-Arms	974-830-24-047	45 / 195	50 / 210	55 / 225
LtR450	2006-14	Wicked ATV (+0.5") A-Arms	974-830-24-011	33 / 120	38 / 140	42 / 145
YAMAHA						
Raptor 125	2011-14	Fireball LT MX	974-830-24-083	35 / 140	35 / 150	40 / 155
Raptor 125	2011-14	Janssen LT MX	974-830-24-083	35 / 140	35 / 150	40 / 155
Raptor 125	2011-14	Lonestar DC4 LT MX	974-830-24-083	35 / 140	40 / 150	45 / 155
Raptor 250	2008-14	Fireball LT MX	974-830-24-083	35 / 140	35 / 150	40 / 155
Raptor 250	2008-14	Janssen LT MX	974-830-24-083	35 / 140	35 / 150	40 / 155
Raptor 250	2008-14	Lonestar DC4 LT MX	974-830-24-083	35 / 140	40 / 150	45 / 155
Raptor 660R	2001-05	Stock Shock Mount (+2") A-Arm (All MFGs)	974-830-24-037	35 / 135	40 / 150	45 / 165
Raptor 700R	2006-14	Alba Action LT (+2") A-Arms	974-830-24-031	34 / 105	38 / 118	42 / 133
Raptor 700R	2006-14	ATV Four-Play Max Ground Clearance (+2") MX	974-830-24-033	38 / 119	42 / 133	46 / 148
Raptor 700R	2006-14	Dab Racing (+3") A-Arms	974-830-24-031	34 / 105	38 / 118	42 / 133
Raptor 700R	2006-14	Denton (+3") A-Arms	974-830-24-031	34 / 105	38 / 118	42 / 133
Raptor 700R	2006-14	Fireball MX (+3") A-Arms	974-830-24-031	34 / 105	38 / 118	42 / 133
Raptor 700R	2006-14	Houser LT XC (+0.5") A-Arms (old style)	974-830-24-067	30 / 140	35 / 150	40 / 160
Raptor 700R	2006-14	Houser MX Pro Series Slicast (+2.25") A-Arms	974-830-24-067	30 / 140	35 / 150	40 / 160
Raptor 700R	2006-14	Houser MX RT (+2") A-Arms (old style)	974-830-24-031	38 / 120	42 / 135	46 / 146
Raptor 700R	2006-14	Hy-Tech ATV (+3") A-Arms	974-830-24-031	34 / 105	38 / 118	42 / 133



Vanteet ja renkaat



Talvituotteet



Vinssit



Laukut ja tuulisuojat



Sähköosat



Jousitus ja voimansiirto



Pakoputket ja suutinsarjat



Ohjaukset



Rungon osat ja peitteet



Jarrupalat ja ratat



Moottori



Variaattorin osat



Maatalous-tarvikkeet



Kärryt ja reet

ATV

Iskunvaimentimet: FLOAT 3 EVOL RC2 JATKUU



Malli	Vuosimalli	Spec	Tuotenumero	Ilima paine säädöt (Main/Evol)		
				-65kg	65-90kg	90kg-
YAMAHA						
Raptor 700R	2006-14	Inland ATV (+3") A-Arms	974-830-24-031	34 / 105	38 / 118	42 / 133
Raptor 700R	2006-14	Janssen MX (+3") A-Arms	974-830-24-031	34 / 105	38 / 118	42 / 133
Raptor 700R	2006-14	JB MX (+2.375") A-Arms (old style)	974-830-24-033	38 / 119	42 / 133	46 / 148
Raptor 700R	2006-14	JB MX (+2.375") A-Arms (longer shock for 2007)	974-830-24-031	35 / 110	39 / 123	43 / 137
Raptor 700R	2006-14	KBR (+3") A-Arms	974-830-24-031	34 / 105	38 / 118	42 / 133
Raptor 700R	2006-14	Laeger's MX (+2.375") A-Arms (old style)	974-830-24-033	38 / 119	42 / 133	46 / 148
Raptor 700R	2006-14	Laeger's Pro-Traxx MX (+2.375") A-Arms (old style)	974-830-24-033	38 / 119	42 / 133	46 / 148
Raptor 700R	2006-14	Leager's MX (+2.375") A-Arms (new style)	974-830-24-031	35 / 110	39 / 123	43 / 137
Raptor 700R	2006-14	Leager's Pro-Trax MX (+2.375") A-Arms (new style)	974-830-24-031	35 / 110	39 / 123	43 / 137
Raptor 700R	2006-14	Lonestar DC-4 MX (+2") A-Arms	974-830-24-031	34 / 105	38 / 118	42 / 133
Raptor 700R	2006-14	Phil Tomlin Racing (+3") A-Arms	974-830-24-031	34 / 105	38 / 118	42 / 133
Raptor 700R	2006-14	Quad Briel (+3") A-Arms	974-830-24-031	34 / 105	38 / 118	42 / 133
Raptor 700R	2006-14	Roll Design MX (+3") A-Arms	974-830-24-031	34 / 105	38 / 118	42 / 133
Raptor 700R	2006-14	Sandragon (+3") A-Arms	974-830-24-031	34 / 105	38 / 118	42 / 133
Raptor 700R	2006-14	Stock Shock Mount (+2") A-Arm (All MFGs)	974-830-24-037	30 / 120	32 / 130	35 / 140
Raptor 700R	2006-14	Stock Shock Mount (Stock) A-Arms	974-830-24-037	27 / 100	30 / 110	33 / 120
Raptor 700R	2006-14	Walsh LT MX (+3") A-Arms	974-830-24-031	35 / 110	39 / 123	43 / 137
Raptor 700R	2006-14	Wicked ATV (+3") A-Arms	974-830-24-031	34 / 105	38 / 118	42 / 133
YZF 450	2003-08, 12-14	Alba Action LT (+2") A-Arms	974-830-24-031	34 / 105	38 / 118	42 / 133
YZF 450	2003-08, 12-14	ATV Four-Play Max Ground Clearance (+2") MX	974-830-24-033	38 / 119	42 / 133	46 / 148
YZF 450	2003-08, 12-14	Dab Racing (+3") A-Arms	974-830-24-031	34 / 105	38 / 118	42 / 133
YZF 450	2003-08, 12-14	Denton (+3") A-Arms	974-830-24-031	34 / 105	38 / 118	42 / 133
YZF 450	2003-08, 12-14	Epic (+3") MX A-Arms	974-830-24-033	38 / 119	42 / 133	46 / 148
YZF 450	2003-08, 12-14	Fireball MX (+3") A-Arms	974-830-24-031	34 / 105	38 / 118	42 / 133
YZF 450	2003-08, 12-14	Houser LT XC (+0.5") A-Arms (old style)	974-830-24-067	30 / 140	35 / 150	40 / 160
YZF 450	2003-08, 12-14	Houser MX Pro Series Slicast (+2.25") A-Arms	974-830-24-067	30 / 140	35 / 150	40 / 160
YZF 450	2003-08, 12-14	Houser MX RT (+2") A-Arms (old style)	974-830-24-031	38 / 120	42 / 135	46 / 146
YZF 450	2003-08, 12-14	Hy-Tech ATV (+3") A-Arms	974-830-24-031	34 / 105	38 / 118	42 / 133
YZF 450	2003-08, 12-14	Inland ATV (+3") A-Arms	974-830-24-031	34 / 105	38 / 118	42 / 133
YZF 450	2003-08, 12-14	Janssen MX (+3") A-Arms	974-830-24-031	34 / 105	38 / 118	42 / 133
YZF 450	2003-08, 12-14	JB MX (+2.375") A-Arms (old style)	974-830-24-033	38 / 119	42 / 133	46 / 148
YZF 450	2003-08, 12-14	JB MX (+2.375") A-Arms (longer shock for 2007)	974-830-24-031	35 / 110	39 / 123	43 / 137
YZF 450	2003-08, 12-14	KBR (+3") A-Arms	974-830-24-031	34 / 105	38 / 118	42 / 133
YZF 450	2003-08, 12-14	Laeger's MX (+2.375") A-Arms (old style)	974-830-24-033	38 / 119	42 / 133	46 / 148
YZF 450	2003-08, 12-14	Laeger's Pro-Traxx MX (+2.375") A-Arms (old style)	974-830-24-033	38 / 119	42 / 133	46 / 148
YZF 450	2003-08, 12-14	Leager's MX (+2.375") A-Arms (new style)	974-830-24-031	35 / 110	39 / 123	43 / 137
YZF 450	2003-08, 12-14	Leager's Pro-Trax MX (+2.375") A-Arms (new style)	974-830-24-031	35 / 110	39 / 123	43 / 137
YZF 450	2003-08, 12-14	Lonestar DC-4 MX (+2") A-Arms	974-830-24-031	34 / 105	38 / 118	42 / 133
YZF 450	2003-08, 12-14	Phil Tomlin Racing (+3") A-Arms	974-830-24-031	34 / 105	38 / 118	42 / 133
YZF 450	2003-08, 12-14	Quad Briel (+3") A-Arms	974-830-24-031	34 / 105	38 / 118	42 / 133
YZF 450	2003-08, 12-14	Roll Design MX (+3") A-Arms	974-830-24-031	34 / 105	38 / 118	42 / 133
YZF 450	2003-08, 12-14	Sandragon (+3") A-Arms	974-830-24-031	34 / 105	38 / 118	42 / 133
YZF 450	2003-08, 12-14	Stock Shock Mount (+2") A-Arm (All MFGs)	974-830-24-037	30 / 120	32 / 130	35 / 140
YZF 450	2003-08, 12-14	Stock Shock Mount (Stock) A-Arms	974-830-24-037	27 / 100	30 / 110	33 / 120
YZF 450	2003-08, 12-14	Walsh LT MX (+3") A-Arms	974-830-24-031	35 / 110	39 / 123	43 / 137
YZF 450	2003-08, 12-14	Wicked ATV (+3") A-Arms	974-830-24-031	34 / 105	38 / 118	42 / 133
YZF 450R	2009-14	Houser Pro Series (+0.5") LT MX	974-830-24-089	30 / 140	35 / 150	40 / 160
YZF 450R	2009-14	Houser (-0.75") XC	974-830-24-095	30 / 140	35 / 150	40 / 160
YZF 450R	2009-14	JB MX	974-830-24-053	30 / 140	35 / 150	40 / 160
YZF 450R	2009-14	Laeger LT MX	974-830-24-107	35 / 150	40 / 150	45 / 160
YZF 450R	2009-14	Roll Design MX A-Arms	974-830-24-001	30 / 140	35 / 150	40 / 160
YZF 450R	2009-14	Stock Shock Mount (Stock) A-Arms	974-830-24-053	30 / 140	35 / 150	40 / 160
YZF 450R	2009-14	Walsh MX FLOW A-Arms	974-830-24-045	30 / 140	35 / 150	40 / 160
YZF 450R	2009-14	Stock Shock Mount (Stock) A-Arms (Wienen Signature Series)	974-830-24-128	30 / 140	35 / 150	40 / 160
YZF 450R	2009-14	Walsh MX FLOW A-Arms (Wienen Signature Series)	974-830-24-127	30 / 140	35 / 150	40 / 160
YZF 450X	2010-11	Stock Shock Mount (Stock) A-Arms	974-830-24-117	35 / 140	40 / 150	45 / 160



Vanteet ja renkaat



Talvituotteet



Vinsit



Laukut ja tuulisuojat



Sähköosat



Jousitus ja voimansiirto



Pakoputket ja suutinsarjat



Ohjaus



Rungon osat ja peitteet



Jarrupalat ja rattaat



Moottori



Variaattorin osat



Maatalous-tarvikkeet



Kärryt ja reet

ATV



Huom! Jouset pitää tilata erikseen.

uutuus!

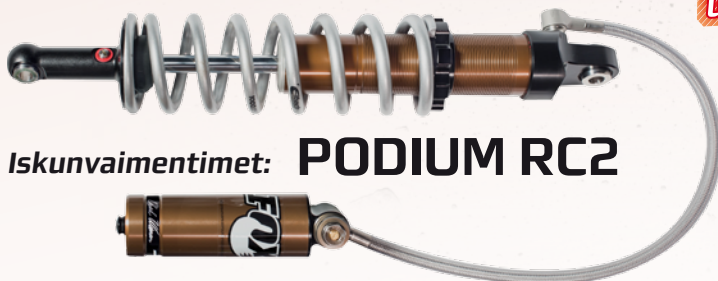

Iskunvaimentimet: **PODIUM RC2**

- DSC = Dual Speed Compression (nopea ja hidas puristusvaimennus)
- Wide Range Rebound = Paluuvaimennuksen säätö
- Lisäsäiliö letkun päässä.
- B.O.C = Bottom Out Control

Hinta alk. 999 € / kpl

- Vanteet ja renkaat
- Talvituotteet
- Vinssit
- Laukut ja tuulisuojat
- Sähköosat
- Jousitus ja voimansiirto
- Pakoputket ja suutinsarjat
- Ohjaus
- Rungon osat ja peitteet
- Jarrupalat ja rattaat
- Moottori
- Variaattorin osat
- Maatalous-tarvikkeet
- Kärryt ja reet

Malli	VM	Tekniset tiedot	Tuotenumero	Jouset			Lisäsäiliö	B.O.C.	Jousi	
				- 65 kg	65-90 kg	90 kg -				
CAN-AM										
DS 450	2007-14	Stock Swingarm / Moto-works MX Link	974-931-04-051	8" x 275	8" x 300	8" x 325	Kauko	Kyllä	1 jousella	999,00
DS 450	2007-14	Stock Swingarm / Stock MX Link	974-931-04-035	8" x 225 / 1000	8" x 225 / 1300	8" x 250 / 1300	Kauko	-	2 jousella	1 099,00
HONDA										
TRX 700XX (2 shocks)	2008-09	Stock A arms	974-831-27-015	-	10" x 250 / 2.5 x 900	-	Kauko	-	2 jousella	1 099,00
TRX 450R	2004-05	ARS-FX XC Swingarm and Linkage	974-931-04-014	8" x 250 / 900	8" x 275 / 1000	8" x 300 / 1000	Kauko	-	2 jousella	1 099,00
TRX 450R	2004-05	Roll (+0.75") Swingarm / Stock Link	974-931-04-001	7" x 450 / 900	7" x 450 / 1000	7" x 475 / 1000	Kauko	-	2 jousella	1 099,00
TRX 450R	2004-05	Stock Swingarm / Stock Link	974-931-04-001	7" x 425 / 900	7" x 450 / 900	7" x 475 / 900	Kauko	-	2 jousella	1 099,00
TRX 450R	2006-14	ARS-FX XC Swingarm and Linkage	974-931-04-014	8" x 250 / 900	8" x 275 / 1000	8" x 300 / 1000	Kauko	-	2 jousella	1 099,00
TRX 450R	2006-14	JB (+0.5") Swingarm / JB Link	974-931-04-008	8" x 225 / 600	8" x 250 / 600	8" x 275 / 700	Kauko	-	2 jousella	1 099,00
TRX 450R	2006-14	JB (+0.5") Swingarm / Stock Link	974-931-04-001	7" x 325 / 600	7" x 350 / 700	7" x 375 / 800	Kauko	-	2 jousella	1 099,00
TRX 450R	2006-14	Laeger (+0.5") Swingarm / Stock Link	974-931-04-001	7" x 325 / 600	7" x 350 / 700	7" x 375 / 800	Kauko	-	2 jousella	1 099,00
TRX 450R	2006-14	Lonestar (+0.5") Swingarm / Stock Link	974-931-04-001	7" x 325 / 600	7" x 350 / 700	7" x 375 / 800	Kauko	-	2 jousella	1 099,00
TRX 450R	2006-14	Stock Swingarm / Baldwin Link XC	974-931-04-009	9" x 325	9" x 350	9" x 375	Kauko	-	1 jousella	999,00
TRX 450R	2006-14	Stock Swingarm / GT Thunder Link	974-931-04-009	9" x 325	9" x 350	9" x 375	Kauko	-	1 jousella	999,00
TRX 450R	2006-14	Six5 Designs Swingarm / Six5 Designs MX Link	974-931-04-056	9" x 175	9" x 200	9" x 225	Kauko	-	1 jousella	999,00
TRX 450R	2006-14	Stock Swingarm / Stock Link	974-931-04-001	7" x 300 / 600	7" x 300 / 700	7" x 325 / 700	Kauko	-	2 jousella	1 099,00
TRX 450R	2006-14	Stock Swingarm / Lonestar DC-6 Link MX	974-931-04-027	7" x 425 / 900	7" x 450 / 1000	7" x 475 / 1000	Kauko	-	2 jousella	1 099,00
TRX 450R	2006-14	Walsh EZ 25:17 Swingarm / Walsh Link	974-931-04-040	9" x 200	9" x 225	9" x 250	Kauko	-	1 jousella	999,00
KAWASAKI										
KFX 450	2007-14	Stock Swingarm / Stock Link	974-931-04-025	9" x 200	9" x 225	9" x 250	Kauko	-	1 jousella	999,00
KFX 450	2007-14	(+1") Swingarm All Makes / Stock Link	974-931-04-025	9" x 200	9" x 225	9" x 250	Kauko	-	1 jousella	999,00
KTM										
450, 505 SX	2009-14	Stock Swingarm	974-931-04-042	8" x 375 / 1000	8" x 400 / 1300	8" x 425 / 1300	Kauko	Kyllä	2 jousella	1 099,00
450, 525 XC	2009-14	Stock Swingarm	974-931-04-044	9" x 350	9" x 375	9" x 400	Kauko	Kyllä	1 jousella	999,00
SUZUKI										
LTR 450	2006-14	Stock Swingarm / GT Thunder Link MX	974-931-04-015	9" x 350	9" x 375	9" x 400	Kauko	Kyllä	1 jousella	999,00
LTR 450	2006-14	Stock Swingarm / KOQ Link	974-931-04-016	9" x 225	9" x 250	9" x 275	Kauko	-	1 jousella	999,00
LTR 450	2006-14	Stock Swingarm / Stock Link (MX valved)	974-931-04-015	9" x 325	9" x 350	9" x 375	Kauko	Kyllä	1 jousella	999,00
LTR 450	2006-14	Stock Swingarm / Stock Link (XC valved)	974-931-04-050	9" x 375	9" x 400	9" x 425	Kauko	-	1 jousella	999,00
LTR 450	2006-14	Stock Swingarm / Walsh Link	974-931-04-016	9" x 225	9" x 250	9" x 275	Kauko	-	1 jousella	999,00
LTR 450	2006-14	(+1") Swingarm All Makes / Stock Link	974-931-04-015	9" x 350	9" x 375	9" x 400	Kauko	Kyllä	1 jousella	999,00
YAMAHA										
Banshee	1987-06	Stock Swingarm (removal of stock air box required)	974-931-04-048	8" x 350	8" x 375	8" x 400	Kauko	-	1 jousella	999,00

ATV

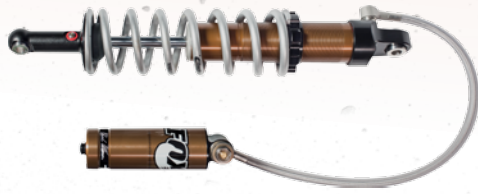

Iskunvaimentimet: PODIUM RC2 JATKUU



Malli	VM	Tekniset tiedot	Tuotenumero	Jouset			Lisäsäiliö	B.O.C.	Jousi	
				- 65 kg	65-90 kg	90 kg -				
Raptor 125	2011-14	Stock Swingarm	974-931-04-039	8" x 225	8" x 250	8" x 275	Kauko	-	1 jousella	999,00
Raptor 250	2008-14	Stock Swingarm	974-931-04-039	8" x 225	8" x 250	8" x 275	Kauko	-	1 jousella	999,00
Raptor 700R	2006-14	Stock Swingarm / Stock Link	974-931-04-024	7" x 325 / 800	7" x 350 / 800	7" x 375 / 900	Kauko	-	2 jousella	1 099,00
YFZ 450	2003-05	JB Stock Swingarm / Stock Link	974-931-04-018	9" x 275 / 700	9" x 300 / 700	9" x 325 / 800	Kauko	-	2 jousella	1 099,00
YFZ 450	2003-05	Laeger Stock Swingarm / Stock Link	974-931-04-018	9" x 275 / 700	9" x 300 / 700	9" x 325 / 800	Kauko	-	2 jousella	1 099,00
YFZ 450	2003-05	Lonestar Stock Swingarm / Stock Link	974-931-04-018	9" x 275 / 700	9" x 300 / 700	9" x 325 / 800	Kauko	-	2 jousella	1 099,00
YFZ 450	2003-05	Roll (+0.5") Swingarm / Stock Link	974-931-04-018	9" x 300 / 700	9" x 325 / 800	9" x 350 / 900	Kauko	-	2 jousella	1 099,00
YFZ 450	2003-05	Stock Swingarm / Stock Link	974-931-04-018	9" x 275 / 700	9" x 300 / 700	9" x 325 / 800	Kauko	-	2 jousella	1 099,00
YFZ 450	2003-05	Walsh Stock Swingarm / Stock Link	974-931-04-018	9" x 275 / 700	9" x 300 / 700	9" x 325 / 800	Kauko	-	2 jousella	1 099,00
YFZ 450	2006-08, 12-14	Houser Stock Swingarm / Stock Link	974-931-04-022	9" x 275 / 700	9" x 300 / 800	9" x 325 / 900	Kauko	-	2 jousella	1 099,00
YFZ 450	2006-08, 12-14	JB Stock Swingarm / Stock Link	974-931-04-022	9" x 275 / 700	9" x 300 / 800	9" x 325 / 900	Kauko	-	2 jousella	1 099,00
YFZ 450	2006-08, 12-14	Laeger Stock Swingarm / Stock Link	974-931-04-022	9" x 275 / 700	9" x 300 / 800	9" x 325 / 900	Kauko	-	2 jousella	1 099,00
YFZ 450	2006-08, 12-14	Lonestar Stock Swingarm / Stock Link	974-931-04-022	9" x 275 / 700	9" x 300 / 800	9" x 325 / 900	Kauko	-	2 jousella	1 099,00
YFZ 450	2006-08, 12-14	Roll (-0.5") Swingarm / Stock Link	974-931-04-018	9" x 300 / 700	9" x 325 / 800	9" x 350 / 900	Kauko	-	2 jousella	1 099,00
YFZ 450	2006-08, 12-14	Stock Swingarm / Stock Link	974-931-04-022	9" x 275 / 700	9" x 300 / 800	9" x 325 / 900	Kauko	-	2 jousella	1 099,00
YFZ 450	2006-08, 12-14	Walsh Stock Swingarm / Stock Link	974-931-04-022	9" x 275 / 700	9" x 300 / 800	9" x 325 / 900	Kauko	-	2 jousella	1 099,00
YFZ 450R	2009-14	Stock Swingarm / Stock Link	974-931-04-041	9" x 200	9" x 225	9" x 250	Kauko	Kyllä	1 jousella	999,00
YFZ 450R	2009-14	Stock Swingarm / Stock Link (Wienen Signature Series)	974-931-04-059	9" x 200	9" x 225	9" x 250	Kauko	Kyllä	1 jousella	1 099,00
YFZ 450R	2010-11	Stock Swingarm / Walsh Link (Wienen Signature Series)	974-931-04-058	9" x 225	9" x 250	9" x 275	Kauko	Kyllä	1 jousella	1 099,00
YFZ 450X	2010-11	Stock Swingarm / Stock Link	974-931-04-054	9" x 225	9" x 250	9" x 275	Kauko	Kyllä	1 jousella	1 099,00 €



Podium RC2-jouset

Tuotenumero	Pituus Tuuma"	Jäykkyys lbs	Sisämitta Tuuma"	Hinta
972-039-21-100	9.0"	175	2.25"	110,00
972-039-21-000	9.0"	200	2.25"	110,00
972-039-21-001	9.0"	225	2.25"	110,00
972-039-21-002	9.0"	250	2.25"	110,00
972-039-21-003	9.0"	275	2.25"	110,00
972-039-21-004	9.0"	300	2.25"	110,00
972-039-21-005	9.0"	325	2.25"	110,00
972-039-21-006	9.0"	350	2.25"	110,00
972-039-21-007	9.0"	375	2.25"	110,00
972-039-21-008	9.0"	400	2.25"	110,00
972-039-21-009	9.0"	425	2.25"	110,00
972-039-21-010	9.0"	450	2.25"	110,00
972-039-21-011	9.0"	475	2.25"	110,00
972-039-21-012	9.0"	500	2.25"	110,00
972-039-21-000-1	9.0"	200	2.25"	110,00
972-039-21-001-1	9.0"	225	2.25"	110,00
972-039-21-002-1	9.0"	250	2.25"	110,00
972-039-21-003-1	9.0"	275	2.25"	110,00
972-039-21-004-1	9.0"	300	2.25"	110,00
972-039-21-005-1	9.0"	325	2.25"	110,00
972-039-21-006-1	9.0"	350	2.25"	110,00
972-039-21-007-1	9.0"	375	2.25"	110,00
972-039-21-008-1	9.0"	400	2.25"	110,00
972-039-21-009-1	9.0"	425	2.25"	110,00

Tuotenumero	Pituus Tuuma"	Jäykkyys lbs	Sisämitta Tuuma"	Hinta
972-039-18-000	8.0"	200	2.25"	110,00
972-039-18-001	8.0"	225	2.25"	110,00
972-039-18-002	8.0"	250	2.25"	110,00
972-039-18-003	8.0"	275	2.25"	110,00
972-039-18-004	8.0"	300	2.25"	110,00
972-039-18-005	8.0"	325	2.25"	110,00
972-039-18-006	8.0"	350	2.25"	110,00
972-039-18-007	8.0"	375	2.25"	110,00
972-039-18-008	8.0"	400	2.25"	110,00
972-039-18-009	8.0"	425	2.25"	110,00
972-039-18-010	8.0"	450	2.25"	110,00
972-039-18-011	8.0"	475	2.25"	110,00
972-039-18-012	8.0"	500	2.25"	110,00
972-039-18-013	8.0"	550	2.25"	110,00
972-039-18-100	8.0"	200	2.25"	110,00
972-039-18-101	8.0"	225	2.25"	110,00
972-039-18-102	8.0"	250	2.25"	110,00
972-039-18-103	8.0"	275	2.25"	110,00
972-039-18-104	8.0"	300	2.25"	110,00
972-039-18-105	8.0"	325	2.25"	110,00
972-039-18-106	8.0"	350	2.25"	110,00
972-039-18-107	8.0"	375	2.25"	110,00
972-039-18-108	8.0"	400	2.25"	110,00
972-039-18-109	8.0"	425	2.25"	110,00
972-039-18-110	8.0"	450	2.25"	110,00





Podium RC2 -jouset jatkuu

Tuotenumero	Pituus		Sisämitta	
	Tuuma"	lbs	Tuuma"	Hinta
972-039-17-004	7.0"	300	2.25"	110,00
972-039-17-005	7.0"	325	2.25"	110,00
972-039-17-006	7.0"	350	2.25"	110,00
972-039-17-007	7.0"	375	2.25"	110,00
972-039-17-008	7.0"	400	2.25"	110,00
972-039-17-009	7.0"	425	2.25"	110,00
972-039-17-010	7.0"	450	2.25"	110,00
972-039-17-011	7.0"	475	2.25"	110,00
972-039-17-004-1	7.0"	300	2.25"	110,00
972-039-17-005-1	7.0"	325	2.25"	110,00
972-039-17-006-1	7.0"	350	2.25"	110,00
972-039-17-007-1	7.0"	375	2.25"	110,00
972-039-17-008-1	7.0"	400	2.25"	110,00
972-039-17-009-1	7.0"	425	2.25"	110,00
972-039-17-010-1	7.0"	450	2.25"	110,00
972-039-17-011-1	7.0"	475	2.25"	110,00

Tuotenumero	Pituus		Sisämitta	
	Tuuma"	lbs	Tuuma"	Hinta
972-039-20-000	2.75"	500	2.50"	50,00
972-039-20-002	2.75"	600	2.50"	50,00
972-039-20-004	2.75"	700	2.50"	50,00
972-039-20-006	2.75"	800	2.50"	50,00
972-039-20-008	2.75"	900	2.50"	50,00
972-039-20-010	2.75"	1000	2.50"	50,00
972-039-20-011	2.75"	1300	2.50"	50,00
972-039-20-000-1	2.75"	500	2.50"	50,00
972-039-20-002-1	2.75"	600	2.50"	50,00
972-039-20-004-1	2.75"	700	2.50"	50,00
972-039-20-006-1	2.75"	800	2.50"	50,00
972-039-20-008-1	2.75"	900	2.50"	50,00
972-039-20-010-1	2.75"	1000	2.50"	50,00
972-039-20-011-1	2.75"	1300	2.50"	50,00



Vanteet ja renkaat



Talvituotteet



Vinssit



Laukut ja tuulisuojat



Sähköosat



Jousitus ja voimansiirto



Pakoputket ja suutinsarjat



Ohjaukset



Rungon osat ja peitteet



Jarrupalat ja rattaat



Moottori



Variaattorin osat



Maatalous-tarvikkeet



Kärryt ja reet

ATV Utility - työmönkijän iskunvaimentimet

Arctic-Cat							
Tuotennr.	Malli	Vuosimalli	Paikka	A-Varisi	Lisäsäiliö	Jousi	
974-830-27-022	Arctic Cat 700/1000 XT	2010-14	Eteen	Alkup. A-varrella	Kiinteä	1 kpl	
974-831-27-022	Arctic Cat 700/1000 XT	2010-14	Taakse	Alkup. A-varrella	Letkulla	1 kpl	
Can-Am							
Tuotennr.	Malli	Vuosimalli	Paikka	A-Varisi	Lisäsäiliö	Jousi	
974-830-27-017	Can-Am Outlander 500/650/800/1000 Gen II	2012-15	Eteen	Alkup. A-varrella	Kiinteä	1 kpl	
974-831-27-017	Can-Am Outlander 500/650/800/1000 Gen II	2012-15	Taakse	Alkup. A-varrella	Kiinteä	1 kpl	
974-830-27-017	Renegade Gen	2012-15	Eteen	Alkup. A-varrella	Kiinteä	1 kpl	
974-831-27-017	Renegade Gen	2012-15	Taakse	Alkup. A-varrella	Kiinteä	1 kpl	
Polaris							
Tuotennr.	Malli	Vuosimalli	Paikka	A-Varisi	Lisäsäiliö	Jousi	
974-830-27-018	Polaris Sportsman 850XP	2012-14	Eteen	Alkup. A-varrella	Kiinteä	1 kpl	
974-831-27-018	Polaris Sportsman 850XP	2012-14	Taakse	Alkup. A-varrella	Kiinteä	1 kpl	
Yamaha							
Tuotennr.	Malli	Vuosimalli	Paikka	A-Varisi	Lisäsäiliö	Jousi	
974-830-27-020	Yamaha Grizzly 550/700	2014-	Eteen	Alkup. A-varrella	Kiinteä	1 kpl	
974-831-27-020	Yamaha Grizzly 550/700	2014-	Taakse	Alkup. A-varrella	Kiinteä	1 kpl	



Hinta 1199€ / pari

Säädöt:

- Dual Speed Compression (DSC)
- Paluuvaimennuksen säätö
- Jousen esijännitys



Sisältää jouset!



Iskunvaimentimen suojaussit

HUOM! Myydään kappaleittain.

Tuotennro	Väri	Mitat	Hinta
862-64263	Lyhyt	7x28cm	15,00
862-64264	Pitkä	7,6x33cm	15,00



KIERREJOUSET

25% jäykemmät kuin alkuperäiset.



CAN-AM	ETEEN		TAAKSE	
400 Outlander Std 03-011			78-320020	78,00
400 Outlander XT 03-011			78-320020	78,00
500 Outlander Std / XT 07			78-322000	78,00
500 Outlander Std 06-07			78-322000	78,00
500 Outlander 08-12			78-325107	78,00
650 Outlander XT 06-07			78-322000	78,00
650 Outlander Std 08-11	78-322010	78,00	78-325107	78,00
650 Outlander XT 08-12	78-325104	78,00	78-325107	78,00
650 Outlander XT-P 10-11	78-325104	78,00	78-325107	78,00
650 Outlander Max XT 09-12	78-325104	78,00	78-325107	78,00
800 Outlander XT 06-07			78-322000	78,00
800 Outlander Std 06-07	78-322010	78,00	78-322000	78,00
800 Outlander Std 08-11	78-322010	78,00	78-325107	78,00
800 Outlander XT 08-11	78-325104	78,00	78-325107	78,00
800 Outlander XT-P 10-11	78-325104	78,00	78-325107	78,00
800 Outlander Max Limited 10-12	78-325104	78,00	78-325107	78,00
800R Outlander Max XT 09-12	78-325104	78,00	78-325107	78,00
800R Outlander Max XT-P 10-12	78-325104	78,00	78-325107	78,00
POLARIS	ETEEN		TAAKSE	
250,300,325,330,350 93-06	78-321450	68,00		
400 Sportsman 4x4 05 (after 9-6-04)	78-322010	78,00	78-321519	68,00
400 Sportsman 4x4 05 (before 9-6-04)	78-322010	78,00	78-321520	68,00
400 Sportsman 4x4 01-04	78-321450	68,00	78-321519	68,00
400 Sportsman 4x4 93-97	78-321450	68,00		
400 Xplorer 4x4 95-02	78-321450	68,00		
400 Xpress 2x4 96-97	78-321450	68,00		
425 Magnum 2x4/4x4 95-98	78-321450	68,00		
425 Xpedition 4x4 00-02	78-321450	68,00		
450 Sportsman 06-07 (after 7/29/05)	78-322010	78,00	78-321520	68,00
450 Sportsman 06 (before 7/29/05)	78-322010	78,00	78-321519	68,00
500 Magnum 4x4 99-02	78-321450	68,00		
500 Magnum RMK 4x4 02	78-321450	68,00		
500 Sportsman 4x4 96-01	78-321450	68,00	78-321519	68,00
500 Sportsman EFI 4x4 06-11	78-322010	78,00	78-321520	68,00
500 Sportsman EFI Touring 4x4 08-11	78-322010	78,00		
500 Sportsman EFI X2 4x4 07-11	78-322010	78,00		
500 Sportsman HO 4x4 08-11	78-322010	78,00	78-321520	68,00
500 Sportsman HO 4x4 06 (after 7/29/05)	78-322010	78,00	78-321520	68,00
500 Sportsman HO 4x4 06 (before 7/29/05)	78-322010	78,00	78-321519	68,00
500 Sportsman HO 4x4 05 (after 9/06/04)	78-322010	78,00	78-321519	68,00
500 Sportsman HO 4x4 05 (before 9/06/04)	78-322010	78,00	78-321520	68,00
500 Sportsman HO 4x4 01-04	78-321450	68,00	78-321519	68,00
500 Sportsman HO Touring 4x4 10	78-322010	78,00		
500 Sportsman X2 4x4 06	78-322010	78,00		
500 Xplorer 4x4 97	78-321450	68,00	78-321519	68,00
550 Sportsman XP 11-14	78-325113	78,00	78-325114	78,00
600 Sportsman 4x4 05 (after 9/06/04)	78-322010	78,00	78-321519	68,00
600 Sportsman 4x4 05 (before 9/06/04)	78-322010	78,00	78-321520	68,00
600 Sportsman 4x4 03-04			78-321519	68,00
700 4x4 Sportsman 06 (after 7/29/05)	78-322010	78,00	78-321520	68,00
700 4x4 Sportsman 06 (before 7/29/05)	78-322010	78,00	78-321519	68,00
700 4x4 Sportsman 4x4 05 (after 9/06/04)	78-322010	78,00	78-321519	68,00
700 Sportsman 4x4 05 (before 9/06/04)	78-322010	78,00	78-321520	68,00
700 Sportsman 4x4 02-04			78-321519	68,00
700 Sportsman EFI 4x4 06-07	78-322010	78,00	78-321520	68,00
700 Sportsman EFI 4x4 05 (after 9/06/04)	78-322010	78,00	78-321519	68,00
700 Sportsman EFI 4x4 05 (before 9/06/04)	78-322010	78,00	78-321520	68,00
700 Sportsman EFI 4x4 04			78-321519	68,00
700 Sportsman EFI X2 4x4 08	78-322010	78,00		
800 Sportsman EFI 4x4 09	78-322010	78,00	78-321520	68,00
800 Sportsman EFI HO 4x4 08	78-322010	78,00	78-321520	68,00
800 Sportsman EFI 4x4 06-07	78-322010	78,00	78-321520	68,00
800 Sportsman EFI 4x4 05	-		78-321519	68,00
800 Sportsman EFI X2 4x4 07-10	78-322010	78,00		
850 Sportsman XP 11-13	78-325113	78,00	78-325114	78,00
YAMAHA				
550 Grizzly 12-14	78-325102	60,00	78-325103	68,00
700 Grizzly 4x4 07-14	78-325102	60,00	78-325103	68,00

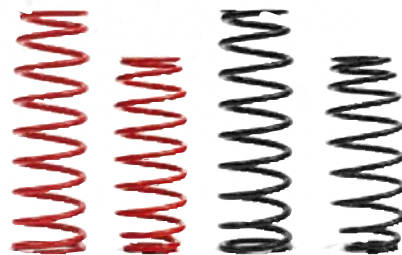

Vanteet ja renkaat



Talvituotteet



Vinsit



Laukut ja tuulisuojat



Sähköosat



Jousitus ja voimansiirto



Pakoputket ja suutinsarjat



Ohjaus



Rungon osat ja peitteet



Jarrupalat ja rattaat



Moottori



Variaattorin osat



Maatalous-tarvikkeet



Kärkyt ja reet

ATV





KOROTUSSARJAT

Lisää maavaraa - nostaa mönkijäsi 5-7,5cm.



Vanteet ja renkaat



Talvituet



Vinsit



Laukut ja tuulisuojat



Sähköosat



Jousitus ja voimansiirto



Pakoputket ja suutinsarjat



Ohjaus



Rungon osat ja peitteet



Jarrupalat ja rattaat



Moottori



Variaattorin osat



Maatalous-tarvikkeet



Kärryt ja reet



ATV



ATV



ATV

ARCTIC CAT	Tuotenro	Hinta
400 FIS 2x4 00-01	78-330104	187,00
400 IRS 4x4 06-07	78-330108	184,00
400 FIS 4x4 00-01	78-330104	187,00
500 Auto/Manual 4x4 00-01	78-330104	187,00
500 IRS 4x4 08-09	78-330107	259,00
500 IRS 4x4 05-07	78-330108	184,00
550 H1 EFI 4x4 09-13	78-330110	158,00
650 Auto/LE/TRV/H1 4x4 05-10	78-330108	184,00
650 H1 Mud Pro 4x4 10	78-330110	158,00
700 EFI/SE 4x4 06-10	78-330108	184,00
700 H1 10-13	78-330110	158,00
700 PROWLER HDX	78-330173	352,00
1000 THUNDER CAT, MUD PRO 09-13	78-330110	158,00
1000 PROWLER XTZ 09-13	78-330173	352,00
CAN-AM		
500 Outlander STD/DPS/XT 13-14	78-330175	391,00
500 Renegade 09-12	78-330174	371,00
500 Renegade 13-14	78-330175	391,00
650 Outlander 4x4 05-09	78-330111	158,00
650 Outlander 4x4 10-12	78-330169	358,00
650 Outlander STD/DPS/XT 13-14	78-330175	391,00
800 Commander 11-14	78-330168	215,00
800 Outlander 4x4 05-09	78-330111	158,00
800 Outlander 4x4 10-11	78-330169	358,00
800 Outlander 4x4 STD/DPS/XT 12-14	78-330175	391,00
800 Renegade 4x4 09-11	78-330174	371,00
800 Renegade 4x4 13-14	78-330175	391,00
1000 Commander 4x4 11-14	78-330168	215,00
1000 Outlander 4x4 STD/DPS/XT 12-14	78-330175	391,00
1000 Maverick STD/XRS	78-330181	317,00
1000 Renegade 12-14	78-330175	391,00
HONDA		
350 Rancher ES/Rancher S 2x4/4x4 00-06	78-330116	165,00
400 Foreman 96-03	78-330117	137,00
400 Rancher AT 4x4 03-06	78-330116	165,00
420 Rancher 2x4/4x4 07-13	78-330119	158,00
420 Rancher IRS 09-14	78-330120	178,00
500 Foreman ES/Foreman S 05-11	78-330121	144,00
500 Rubicon 01-14	78-330121	144,00
500 Foreman ES/PS 12-13	78-330182	135,00
650 Rincon 03-05	78-330122	164,00
680 Rincon 06-14	78-330122	164,00
700 Big Red 09-12	78-330123	164,00
KAWASAKI		
650 Brute Force straight axle 4x4 05-13	78-330124	265,00
650 Brute Force IRS 4x4 06-13	78-330125*	215,00
650 Prairie 4x4 02-05	78-330124	265,00
700 Prairie 4x4 03-09	78-330124	265,00
750 Brute Force IRS 4x4 05-14	78-330125*	215,00

POLARIS		
400 Ranger 10-13	78-330165	125,50
450 Sportsman 4x4 06-08	78-330137	251,00
500 Ranger 4x4 06-07	78-330138	215,00
500 Ranger EFI 4x4 06-10	78-330138	215,00
500 Ranger EFI 4x4 11-13	78-330165	125,50
500 Sportsman 4x4 97-01	78-330133	173,00
500 Sportsman EFI 4x4 06-10	78-330140	211,00
500 Sportsman EFI X2 4x4 06	78-330136	184,00
500 Sportsman HO 4x4 03-05	78-330136	184,00
500 Sportsman HO 4x4 06-12	78-330140	211,00
570 RZR 12-14	78-330179	194,00
600 Sportsman 4x4 03-05	78-330137	251,00
700 Ranger Crew 4x4 08-09	78-330138	215,00
700 Ranger XP 4x4 06-08	78-330138	215,00
700 Sportsman 4x4 02-06	78-330137	251,00
700 Sportsman EFI 4x4 04-07	78-330140	211,00
700 Sportsman EFI X2 4x4 08	78-330137	251,00
800 Sportsman EFI 4x4 07-12	78-330140	211,00
800 Sportsman EFI X2 4x4 08	78-330137	251,00
900 Ranger XP 13-14 (4")	78-330183	188,00
1000 RZR XP 14 (3")	78-330184	375,00
SUZUKI		
250 Ozark 2x4 02-07	78-330143	123,00
400 Eiger 2x4/4x4 02-07	78-330144	184,00
450 King Quad 4x4 07-09	78-330148*	144,00
500 King Quad 4x4 11-12	78-330178*	231,00
500 Quad Master 00-01	78-330146	144,00
500 Quad Runner 01	78-330146	144,00
500 Vinson 4x4 02-07	78-330147	205,00
700 King Quad 4x4 05-07	78-330148*	144,00
750 King Quad 4x4 08-10	78-330148	144,00
750 King Quad 4x4 11-13	78-330178*	231,00
YAMAHA		
350 Bruin 4x4 04-06	78-330155	173,00
400 Big Bear 2x4 01-04	78-330153	173,00
400 Big Bear 4x4 00-06	78-330153	173,00
400 Big Bear IRS 4x4 07-12	78-330154	201,00
400 Kodiak 2x4 00-01/03-04	78-330155	173,00
400 Kodiak 4x4 00-06 (straight rear axle)	78-330155	173,00
400 Kodiak IRS 4x4 05-06	78-330157	173,00
450 Grizzly IRS 4x4 07-12	78-330156	201,00
450 Grizzly IRS 4x4 13-14	78-330185	182,00
450 Kodiak 4x4 03-04 (straight rear axle)	78-330155	173,00
450 Kodiak IRS 4x4 05-06	78-330157	173,00
550 Grizzly 4x4 09-14	78-330172	141,00
700 Grizzly 4x4 07-12	78-330172	141,00

(* Must use wheel spacers)

TÄYDELLISET VETOAKSELIT ETEEN JA TAAKSE JATKUU



VUOSIMALLI	Eteen		VASEN		OIKEA		TAAKSE		VASEN		OIKEA		Vahvistettu		Osh.
		STD	STD	Osh.	STD	Osh.	STD	Osh.	STD	Osh.	STD	Osh.	STD	Osh.	
OUTLANDER 400	Eteen			78-28-25100-1	220,80	78-28-25101-1	220,80								
OUTLANDER MAX 400	Eteen			78-28-25100-1	220,80	78-28-25101-1	220,80								
OUTLANDER 500,MAX	Eteen			78-28-25100-1	220,80	78-28-25101-1	220,80	TAAKSE						78-28-25104-1	220,80
RENEGADE 500	Eteen			78-28-25100-1	220,80	78-28-25101-1	220,80	TAAKSE						78-28-25104-1	220,80
OUTLANDER 650,MAX	Eteen			78-28-25100-1	220,80	78-28-25101-1	220,80	TAAKSE						78-28-25104-1	220,80
COMMANDER 800	Eteen	78-28-25102	198,70			78-28-25103	198,70							78-28-25104-1	220,80
OUTLANDER 800	Eteen			78-28-25100-1	220,80	78-28-25101-1	220,80	TAAKSE						78-28-25104-1	220,80
OUTLANDER MAX 800R	Eteen			78-28-25100-1	220,80	78-28-25101-1	220,80	TAAKSE						78-28-25104-1	220,80
OUTLANDER 1000	Eteen			78-28-25100-1	220,80	78-28-25101-1	220,80	TAAKSE						78-28-25104-1	220,80
OUTLANDER 1000	Eteen			78-28-25100-1	220,80	78-28-25101-1	220,80	TAAKSE						78-28-25104-1	220,80
RENEGADE 800	Eteen	78-28-25115	198,70			78-28-25116	198,70							78-28-25104-1	220,80
RENEGADE 1000	Eteen													78-28-25104-1	220,80
RENEGADE 1000	Eteen	78-28-25115	198,70			78-28-25116	198,70							78-28-25104-1	220,80
COMMANDER 800	Eteen	78-28-25102	198,70			78-28-25103	198,70							78-28-25106-1	220,80
COMMANDER 800	Eteen	78-28-25102	198,70			78-28-25103-1	220,80	TAAKSE						78-28-25106-1	220,80
COMMANDER 1000	Eteen	78-28-25102	198,70			78-28-25103-1	220,80	TAAKSE						78-28-25106-1	220,80
MAVERICK 1000	Eteen	78-28-25102	198,70			78-28-25103-1	220,80	TAAKSE						78-28-25119-1	220,80
CF-MOTO															
CF-MOTO 500 5/5A/5B/5C		78-28-14001	170,40			78-28-14002	170,40							78-28-14003	170,40
CF-MOTO 525		78-28-14005	170,40			78-28-14006	170,40							78-28-14007	170,40
CF-MOTO 625		78-28-14005	170,40			78-28-14006	170,40							78-28-14007	170,40
HISUN															
500				78-28-10088	192,00	78-28-10089	192,00							78-28-10092	192,00
500 UTV		78-28-11030	170,40			78-28-11031	170,40							78-28-11028	170,40
600				78-28-10088	192,00	78-28-10089	192,00							78-28-10092	192,00
600 UTV		78-28-11030	170,40			78-28-11031	170,40							78-28-11028	170,40
700				78-28-10088	192,00	78-28-10089	192,00							78-28-10092	192,00
700 UTV		78-28-11030	170,40			78-28-11031	170,40							78-28-11028	170,40
800		78-28-11024	170,40			78-28-11025	170,40							78-28-11028	170,40
800 UTV		78-28-11022	170,40			78-28-11023	170,40							78-28-11027	170,40
800 UTV (800-2 UTV New front Bridge)		78-28-11036	170,40			78-28-11036	170,40								
HONDA															
TRX350	Eteen	78-28-65110	170,40			78-28-65110	170,40								
TRX400 FOREMAN	Eteen	78-28-65101	170,40			78-28-65105	170,40								
TRX400 RANCHER	Eteen	78-28-65111	170,40			78-28-65111	170,40								
TRX 420	Eteen	78-28-65116	170,40			78-28-65116	170,40								
TRX450	Eteen	78-28-65103	170,40			78-28-65107	170,40							78-28-65119-1	189,40
TRX500 RUBICON	Eteen	78-28-65102	170,40			78-28-65106	170,40								
TRX500 RUBICON FOREMAN	Eteen	78-28-65104	170,40			78-28-65109	170,40								



TÄYDELLISET VETOAKSELIT ETEEN JA TAAKSE JATKUJ



VUOSIMALLI	Eteen	VAASEN		OIKEA		Vahvistettu	Osh.	VAASEN		OIKEA		Vahvistettu	Osh.	VAASEN		OIKEA		Vahvistettu	Osh.	
		STD	Osh.	STD	Osh.			STD	Osh.	STD	Osh.			STD	Osh.	STD	Osh.			
2006-07	Eteen	78-28-45102	198,70	78-28-45102	198,70			78-28-45109	170,40	78-28-45109	170,40			78-28-45109	170,40	78-28-45109	170,40			
2004	Eteen	78-28-45105	198,70	78-28-45105	198,70															
2002	Eteen	78-28-45105	198,70	78-28-45105	198,70															
2002	Eteen	78-28-45105	198,70	78-28-45105	198,70															
2005	Eteen	78-28-45105	198,70	78-28-45105	198,70															
2006-07	EV																			
2010	AR	78-28-45126	198,70	78-28-45126	198,70															
2011-13	Eteen	78-28-45137	198,70	78-28-45137	198,70															
1999-03	Eteen	78-28-45105	198,70	78-28-45105	198,70															
1996	Eteen	78-28-45105	198,70	78-28-45105	198,70															
1997	Eteen	78-28-45105	198,70	78-28-45105	198,70															
1998	Eteen	78-28-45105	198,70	78-28-45105	198,70															
1999	Eteen	78-28-45105	198,70	78-28-45105	198,70															
2000-01	Eteen	78-28-45105	198,70	78-28-45105	198,70															
2002	Eteen	78-28-45105	198,70	78-28-45105	198,70															
2003	Eteen	78-28-45102	198,70	78-28-45102	198,70															
2004	Eteen	78-28-45103	170,40	78-28-45103	170,40															
2005	Eteen	78-28-45107	170,40	78-28-45107	170,40															
2006-10	Eteen	78-28-45107	170,40	78-28-45107	170,40															
2011-12	Eteen	78-28-45138	198,70	78-28-45138	198,70															
2013-14	Eteen	78-28-45103	170,40	78-28-45103	170,40															
2006	Eteen	78-28-45107	170,40	78-28-45107	170,40															
2008-10	Eteen	78-28-45138	198,70	78-28-45138	198,70															
2011-13	Eteen	78-28-45107	170,40	78-28-45107	170,40															
2007	Eteen	78-28-45107	170,40	78-28-45107	170,40															
2008-09	Eteen	78-28-45107	170,40	78-28-45107	170,40															
1999	Eteen	78-28-45105	198,70	78-28-45105	198,70															
1997	Eteen	78-28-45132	170,40	78-28-45132	170,40															
2009	Eteen	78-28-45112-1	189,40	78-28-45112-1	189,40															
2010-14	Eteen	78-28-45112	170,40	78-28-45112	170,40															
2014	Eteen	78-28-45153	170,40	78-28-45153	170,40															
2012-14	Eteen	78-28-45102	198,70	78-28-45102	198,70															
2014	Eteen	78-28-45102	198,70	78-28-45102	198,70															
2003	Eteen	78-28-45103	170,40	78-28-45103	170,40															
2004	Eteen	78-28-45134-1	189,40	78-28-45134-1	189,40															
2005	Eteen	78-28-45114	170,40	78-28-45114	170,40															
2008-10	Eteen	78-28-45114	170,40	78-28-45114	170,40															
2007	Eteen	78-28-45117	170,40	78-28-45117	170,40															
2005-06	Eteen	78-28-45102	198,70	78-28-45102	198,70															
2002	Eteen	78-28-45102	198,70	78-28-45102	198,70															
2003	Eteen	78-28-45102	198,70	78-28-45102	198,70															
2004	Eteen	78-28-45102	198,70	78-28-45102	198,70															
2005	Eteen	78-28-45103	170,40	78-28-45103	170,40															
2008-10	Eteen	78-28-45103	170,40	78-28-45103	170,40															
2007	Eteen	78-28-45114	170,40	78-28-45114	170,40															
2005-06	Eteen	78-28-45102	198,70	78-28-45102	198,70															
2002	Eteen	78-28-45102	198,70	78-28-45102	198,70															
2003	Eteen	78-28-45102	198,70	78-28-45102	198,70															
2004	Eteen	78-28-45102	198,70	78-28-45102	198,70															
2005	Eteen	78-28-45103	170,40	78-28-45103	170,40															
2006-07	Eteen	78-28-45117	170,40	78-28-45117	170,40															
2008	Eteen	78-28-45107	170,40	78-28-45107	170,40															



TÄYDELLISET VETOAKSELIT



ARCTIC CAT	ETEEN			TAAKSE				
	VASEN	HINTA	OIKEA	HINTA	VASEN	HINTA	OIKEA	HINTA
400 2x4 02-04					78-382949	409,00	78-382949	409,00
400 4x4 07-08 w/FIS	78-382944	409,00	78-382945	409,00	78-382950	409,00	78-382950	409,00
400 4x4 06 w/FIS	78-382944	409,00	78-382945	409,00	78-382950	409,00	78-382950	409,00
400 4x4 02-04 w/FIS	78-382949	409,00	78-382949	409,00	78-382949	409,00	78-382949	409,00
400 TBX 4x4 06	78-382945	409,00	78-382945	409,00	78-382950	409,00	78-382950	409,00
400 TRV 4x4 06-08	78-382945	409,00	78-382945	409,00	78-382950	409,00	78-382950	409,00
500 4x4 07-08	78-382944	409,00	78-382945	409,00	78-382950	409,00	78-382950	409,00
500 4x4 06 w/FIS	78-382944	409,00	78-382945	409,00	78-382950	409,00	78-382950	409,00
500 4x4 03-04	78-382949	409,00	78-382949	409,00	78-382949	409,00	78-382949	409,00
500 4x4 02 w/FIS	78-382949	409,00	78-382949	409,00				
500 TBX 4x4 06	78-382944	409,00	78-382945	409,00	78-382950	409,00	78-382950	409,00
500 TRV 4x4 06	78-382945	409,00	78-382945	409,00	78-382950	409,00	78-382950	409,00
650 4x4 06-08	78-382944	409,00	78-382945	409,00	78-382950	409,00	78-382950	409,00
700 EFI Auto 4x4 07-08	78-382944	409,00	78-382945	409,00	78-382950	409,00	78-382950	409,00
700 H1 EFI 4x4 08	78-382944	409,00	78-382945	409,00	78-382950	409,00	78-382950	409,00

CAN-AM	ETEEN			TAAKSE				
	VASEN	HINTA	OIKEA	HINTA	VASEN	HINTA	OIKEA	HINTA
330 Outlander 2x4 04-05*					78-381347	268,00	78-381350	268,00
330 Outlander 4x4 04-05*	78-381800	268,00	78-381800	268,00	78-381347	268,00	78-381350	268,00
400 Outlander 2x4 03-05*					78-381347	268,00	78-381350	268,00
400 Outlander STD/XT 11-12*	78-383004	190,50	78-383003	190,50				
400 Outlander 4x4 06-08*	78-381346	268,00	78-381346	268,00	78-381347	268,00	78-381350	268,00
400 Outlander 4x4 03-05*	78-381800	268,00	78-381800	268,00	78-381347	268,00	78-381350	268,00
500 Outlander STD/XT 11-12*	78-383004	190,50	78-383003	190,50				
500 Outlander 4x4 08*	78-381346	268,00	78-381346	268,00				
500 Outlander 4x4 07*	78-381346	268,00	78-381346	268,00	78-381349	268,00	78-381348	268,00
500 Renegade 4x4 12-*	78-383004	190,50	78-383003	190,50				
500 Renegade 4x4 08-11*	78-381346	268,00	78-381346	268,00				
650 Outlander STD/XT/MAX 11-12*	78-383004	190,50	78-383003	190,50				
650 Outlander 4x4 08*	78-381346	268,00	78-381346	268,00				
650 Outlander 4x4 06-07*	78-381346	268,00	78-381346	268,00	78-381349	268,00	78-381348	268,00
800 Outlander STD/XT/MAX 11-12*	78-383004	190,50	78-383003	190,50				
800 Outlander 4x4 08*	78-381346	268,00	78-381346	268,00				
800 Outlander 4x4 06-07*	78-381346	268,00	78-381346	268,00	78-381349	268,00	78-381348	268,00
800 Renegade 4x4 / Xxc 11-12*	78-383004	190,50	78-383003	190,50				
800 Renegade 4x4 08*	78-381346	268,00	78-381346	268,00				
800 Renegade 4x4 07*	78-381346	268,00	78-381346	268,00	78-381349	268,00	78-381348	268,00
1000 Renegade STD/Xxc 12-*	78-383004	190,50	78-383003	190,50				

HONDA	ETEEN			TAAKSE				
	VASEN	HINTA	OIKEA	HINTA	VASEN	HINTA	OIKEA	HINTA
TRX 300 Fourtrax 4x4 93-00*	78-381042	265,00	78-381042	265,00				
TRX 300 Fourtrax 4x4 88-92*	78-381526	265,00	78-381526	265,00				
TRX 350 Rancher 4x4 00-05*	78-381040	265,00	78-381040	265,00				
TRX 400 Rancher 4x4 04-07*	78-381334	265,00	78-381334	265,00				
TRX 420 Rancher ES 4x4 07-08*	78-382922	283,00	78-382922	283,00				
TRX 500 Foreman 4x4 08-13*	78-382923	283,00	78-382924	283,00				
TRX 500 Foreman 4x4 07*	78-381332	265,00	78-381333	265,00				
TRX 500 Foreman ES 4x4 07*	78-382923	283,00	78-382924	283,00				
TRX 500 Foreman 4x4 05-06*	78-381332	265,00	78-381333	265,00				
TRX 500 Rubicon 4x4 08-13*	78-382923	283,00	78-382924	283,00				
TRX 500 Rubicon 4x4 05-07*	78-381332	265,00	78-381333	265,00				
TRX 500 Rubicon 4x4 01-04*	78-381080	265,00	78-381085	265,00				
TRX 650 Rincon 4x4 05*	78-381332	265,00	78-381333	265,00	78-381090	283,00	78-381090	283,00
TRX 650 Rincon 4x4 03-04*	78-381080	265,00	78-381085	265,00	78-381090	283,00	78-381090	283,00
TRX 680 Rincon 4x4 08-13*	78-382923	283,00	78-382924	283,00	78-381090	283,00	78-381090	283,00
TRX 680 Rincon 4x4 06-07*	78-381332	265,00	78-381333	265,00	78-381090	283,00	78-381090	283,00

KAWASAKI	ETEEN			TAAKSE				
	VASEN	HINTA	OIKEA	HINTA	VASEN	HINTA	OIKEA	HINTA
750i Brute Force 4x4 05-07	78-382959	443,00	78-382960	443,00	78-382961	443,00	78-382961	443,00
750i Brute Force 4x4 08-11					78-382961	443,00	78-382961	443,00
750i Brute Force 4x4 12-13	78-382959	443,00	78-382960	443,00	78-382961	443,00	78-382961	443,00

- Vanteet ja renkaat
- Talvituotteet
- Vinssit
- Laukut ja tuulisuojat
- Sähköosat
- Jousitus ja voimansiirto
- Pakoputket ja suutinsarjat
- Ohjaus
- Rungon osat ja peitteet
- Jarrupalat ja rattaat
- Moottori
- Variaattorin osat
- Maatalous-tarvikkeet
- Kärryt ja reet

ATV

TÄYDELLISET VETOAKSELIT JATKUU



POLARIS	EETEEN			TAAKSE				
	VASEN	HINTA	OIKEA	HINTA	VASEN	HINTA	OIKEA	HINTA
250 4x4 93	78-381012	439,00	78-381012	439,00				
250 6x6 93	78-381012	439,00	78-381012	439,00				
250 Big Boss 6x6 92 (USA)	78-381012	439,00	78-381012	439,00				
250 Big Boss 6x6 91	78-381012	439,00	78-381012	439,00				
250 Trail Boss 4x4 92 (USA)	78-381012	439,00	78-381012	439,00				
250 Trail Boss 4x4 91	78-381012	439,00	78-381012	439,00				
250 Xplorer 4x4 00-02	78-381010	439,00	78-381010	439,00				
300 4x4 95	78-381011	439,00	78-381011	439,00				
300 4x4 94	78-381012	439,00	78-381012	439,00				
300 6x6 94	78-381012	439,00	78-381012	439,00				
300 Sportsman 08-10	78-381340	397,00	78-381340	397,00	78-381341	377,00	78-381341	377,00
300 Hawkeye 2x4 06-10					78-381341	377,00	78-381341	377,00
300 Hawkeye 4x4 06-07	78-381340	397,00	78-381340	397,00	78-381341	377,00	78-381341	377,00
300 Xplorer 4x4 97-99 (after 1/1/97)	78-381000	439,00	78-381000	439,00				
300 Xplorer 4x4 96-97 (before 1/1/97)	78-381011	439,00	78-381011	439,00				
325 Magnum 4x4 00-02 (exc HDS)	78-381000	439,00	78-381000	439,00				
325 Xpedition 4x4 00-02	78-381000	439,00	78-381000	439,00				
330 ATP 4x4 05	78-381304	439,00	78-381304	439,00				
330 ATP 4x4 04	78-381030	498,00	78-381030	498,00				
330 Magnum 4x4 05-06	78-381304	439,00	78-381304	439,00				
330 Magnum 4x4 03-04 (exc HDS)	78-381030	498,00	78-381030	498,00				
335 Sportsman 4x4 99	78-381000	439,00	78-381000	439,00				
335 Worker 4x4 99	78-381000	439,00	78-381000	439,00				
350L 4x4 90/93	78-381012	439,00	78-381012	439,00				
350L 6x6 93	78-381012	439,00	78-381012	439,00				
350L Trail Boss 4x4 92 (USA)	78-381012	439,00	78-381012	439,00				
350L Trail Boss 4x4 90-91	78-381012	439,00	78-381012	439,00				
400 Scrambler 4x4 00-02	78-381010	439,00	78-381010	439,00				
400 Scrambler 4x4 99 (USA)	78-381010	439,00	78-381010	439,00				
400 Scrambler 4x4 99 (BTB)	78-381000	439,00	78-381000	439,00				
400 Scrambler 4x4 98	78-381000	439,00	78-381000	439,00				
400 Scrambler 4x4 97	78-381011	439,00	78-381011	439,00				
400 Scrambler 4x4 95-96 (BTB)	78-381011	439,00	78-381011	439,00				
400 Scrambler 4x4 95-96 (USA)	78-381013	439,00	78-381013	439,00				
400 Sportsman HO 4x4 13					78-383023	273,50	78-383023	273,50
400 Sportsman HO 4x4 11-12	78-383024	273,50	78-383024	273,50	78-383023	273,50	78-383023	273,50
400 Sportsman HO 4x4 08-10	78-381340	397,00	78-381340	397,00	78-381341	377,00	78-381341	377,00
400 Sportsman 4x4 05	78-381335	397,00	78-381335	397,00	78-381302	377,00	78-381302	377,00
400 Sportsman 4x4 04	78-381010	439,00	78-381010	439,00	78-381302	377,00	78-381302	377,00
400 Sportsman 4x4 04	78-381030	498,00	78-381030	498,00	78-381302	377,00	78-381302	377,00
400 Sportsman 4x4 03	78-381010	439,00	78-381010	439,00	78-381302	377,00	78-381302	377,00
400 Sportsman 4x4 02	78-381010	439,00	78-381010	439,00	78-381301	397,00	78-381301	397,00
400 Sportsman 4x4 01	78-381000	439,00	78-381000	439,00	78-381301	397,00	78-381301	397,00
400 Sportsman 4x4 97	78-381000	439,00	78-381000	439,00				
400 Sportsman 4x4 95-96 (BTB)	78-381011	439,00	78-381011	439,00				
400 Sportsman 4x4 95-96 (USA)	78-381013	439,00	78-381013	439,00				
400 Xplorer 4x4 99-02	78-381010	439,00	78-381010	439,00				
400 Xplorer 4x4 97-98 (after 1/1/97)	78-381000	439,00	78-381000	439,00				
400 Xplorer 4x4 97 (before 1/1/97)	78-381011	439,00	78-381011	439,00				
400 Xplorer 4x4 95-96 (BTB)	78-381011	439,00	78-381011	439,00				
400 Xplorer 4x4 95-96 (USA)	78-381013	439,00	78-381013	439,00				
400L 6x6 95 (BTB)	78-381011	439,00	78-381011	439,00				
400L 6x6 94	78-381012	439,00	78-381012	439,00				
400L Big Boss 6x6 97 (after 1/1/97)	78-381000	439,00	78-381000	439,00				
400L Big Boss 6x6 97 (before 1/1/97)	78-381011	439,00	78-381011	439,00				
425 Magnum 4x4 97-98 (after 1/1/97)	78-381000	439,00	78-381000	439,00				
425 Magnum 4x4 97 (before 1/1/97)	78-381011	439,00	78-381011	439,00				
425 Magnum 4x4 95-96 (BTB)	78-381011	439,00	78-381011	439,00				
425 Magnum 4x4 95-96 (USA)	78-381013	439,00	78-381013	439,00				
425 Magnum 6x6 97 (after 1/1/97)	78-381000	439,00	78-381000	439,00				
425 Magnum 6x6 97 (before 1/1/97)	78-381011	439,00	78-381011	439,00				
425 Magnum 6x6 95-96 (BTB)	78-381011	439,00	78-381011	439,00				
425 Magnum 6x6 95-96 (USA)	78-381013	439,00	78-381013	439,00				
425 Xpedition 4x4 02	78-381010	439,00	78-381010	439,00				
425 Xpedition 4x4 00-01	78-381000	439,00	78-381000	439,00				
450 Sportsman 4x4 07					78-381302	377,00	78-381302	377,00
450 Sportsman 4x4 06	78-381335	397,00	78-381335	397,00	78-381302	377,00	78-381302	377,00
500 ATP 4x4 05	78-381304	439,00	78-381304	439,00				
500 ATP 4x4 04	78-381030	498,00	78-381030	498,00				
500 Big Boss 6x6 98-99	78-381000	439,00	78-381000	439,00				
500 Magnum 2x4 02 (HDS)	78-381010	439,00	78-381010	439,00				
500 Magnum 4x4 02 (exc HDS)	78-381020	498,00	78-381020	498,00				
500 Magnum 4x4 99-01 (exc HDS)	78-381000	439,00	78-381000	439,00				
500 Ranger 2x4 05-07					78-381337	439,00	78-381338	439,00



Vanteet ja renkaat



Talvituotteet



Vinssit



Laukut ja tuulisuojat



Sähköosat



Jousitus ja voimansiirto



Pakoputket ja suutinsarjat



Ohjaus



Rungon osat ja peitteet



Jarrupalat ja rattaat



Moottori



Variaattorin osat



Maatalous-tarvikkeet



Kärkyt ja reet

ATV





TÄYDELLISET VETOAKSELIT JATKUU



POLARIS	ETEEN			TAAKSE				
	VASEN	HINTA	OIKEA	HINTA	VASEN	HINTA	OIKEA	HINTA
500 Ranger 4x4 07 (after 8/26/06)	78-381351	397,00	78-381351	397,00	78-381337	439,00	78-381338	439,00
500 Ranger 4x4 07 (before 8/26/06)	78-381351	397,00	78-381351	397,00	78-381337	439,00	78-381338	439,00
500 Ranger 4x4 06	78-381351	397,00	78-381351	397,00	78-381337	439,00	78-381338	439,00
500 Ranger 4x4 05					78-381337	439,00	78-381338	439,00
500 Ranger 4x4 04					78-381337	439,00	78-381338	439,00
500 Ranger EFI 4x4 07	78-381351	397,00	78-381351	397,00	78-381337	439,00	78-381338	439,00
500 Scrambler 4x4 99-07	78-381010	439,00	78-381010	439,00				
500 Scrambler 4x4 97-98 (after 1/1/97)	78-381000	439,00	78-381000	439,00				
500 Scrambler 4x4 97 (before 1/1/97)	78-381011	439,00	78-381011	439,00				
500 Sportsman EFI 4x4 10	78-381038*	268,00	78-381038*	268,00				
500 Sportsman EFI 4x4 09	78-381038*	268,00	78-381038*	268,00	78-383022	273,50	78-383022	273,50
500 Sportsman EFI 4x4 08	78-381038*	268,00	78-381038*	268,00	78-383022	273,50	78-383022	273,50
500 Sportsman EFI 4x4 07	78-381038*	268,00	78-381038*	268,00	78-381302	377,00	78-381302	377,00
500 Sportsman EFI 4x4 06	78-381335	397,00	78-381335	397,00	78-381302	377,00	78-381302	377,00
500 Sportsman Ho touring 11-12	78-383024	273,50	78-383024	273,50				
500 Sportsman Ho touring 10	78-381038*	268,00	78-381038*	268,00				
500 Sportsman HO 4x4 11-12	78-383024	273,50	78-383024	273,50	78-383023	273,50	78-383023	273,50
500 Sportsman HO 4x4 09-10	78-381038*	268,00	78-381038*	268,00				
500 Sportsman HO 4x4 08*	78-381038*	268,00	78-381038*	268,00				
500 Sportsman HO 4x4 06	78-381335	397,00	78-381335	397,00	78-381302	377,00	78-381302	377,00
500 Sportsman HO 4x4 05	78-381335	397,00	78-381335	397,00	78-381302	377,00	78-381302	377,00
500 Sportsman HO 04	78-381010	439,00	78-381010	439,00	78-381302	377,00	78-381302	377,00
500 Sportsman HO 04	78-381030	498,00	78-381030	498,00	78-381302	377,00	78-381302	377,00
500 Sportsman HO 4x4 03	78-381010	439,00	78-381010	439,00	78-381302	377,00	78-381302	377,00
500 Sportsman HO 4x4 02	78-381010	439,00	78-381010	439,00	78-381301	397,00	78-381301	397,00
500 Sportsman HO 4x4 01	78-381000	439,00	78-381000	439,00	78-381301	397,00	78-381301	397,00
500 Sportsman 4x4 99-01	78-381000	439,00	78-381000	439,00	78-381301	397,00	78-381301	397,00
500 Sportsman 4x4 98	78-381000	439,00	78-381000	439,00				
500 Sportsman 4x4 97	78-381010	439,00	78-381010	439,00				
500 Sportsman 4x4 96 (BTB)	78-381011	439,00	78-381011	439,00				
500 Sportsman 4x4 96 (USA)	78-381013	439,00	78-381013	439,00				
500 Sportsman 6x6 02-07	78-381010	439,00	78-381010	439,00				
500 Sportsman 6x6 00-01	78-381000	439,00	78-381000	439,00				
500 Sportsman X2 4x4 06-07					78-381339	439,00	78-381339	439,00
500 Worker 4x4 99	78-381000	439,00	78-381000	439,00	78-381301	397,00	78-381301	397,00
500 Xplorer 4x4 97	78-381010	439,00	78-381010	439,00				
550 Sportman kaikki 11-13	78-383021	273,50	78-383021	273,50	78-383020	273,50	78-383020	273,50
570 RZR 12-13	78-382975	273,50	78-382975	273,50				
600 Sportsman 4x4 05	78-381335	397,00	78-381335	397,00	78-381302	377,00	78-381302	377,00
600 Sportsman 4x4 03-04	78-381030	498,00	78-381030	498,00	78-381302	377,00	78-381302	377,00
700 MV7 4x4 07 (after 7/25/06)					78-381302	377,00	78-381302	377,00
700 MV7 4x4 07 (before 7/25/06)					78-381302	377,00	78-381302	377,00
700 MV7 4x4 06	78-381335	397,00	78-381335	397,00	78-381302	377,00	78-381302	377,00
700 MV7 4x4 05	78-381335	397,00	78-381335	397,00	78-381302	377,00	78-381302	377,00
700 Ranger XP 4x4 07 (after 8/26/06)	78-381351	397,00	78-381351	397,00				
700 Ranger XP 4x4 07 (before 8/26/06)	78-381351	397,00	78-381351	397,00	78-381337	439,00	78-381338	439,00
700 Ranger XP 4x4 06	78-381351	397,00	78-381351	397,00	78-381337	439,00	78-381338	439,00
700 Ranger XP 4x4 05					78-381337	439,00	78-381338	439,00
700 Ranger EFI 6x6 06-07	78-381351	397,00	78-381351	397,00				
700 Sportsman 4x4 06	78-381335	397,00	78-381335	397,00	78-381302	377,00	78-381302	377,00
700 Sportsman 4x4 05	78-381335	397,00	78-381335	397,00	78-381302	377,00	78-381302	377,00
700 Sportsman 4x4 03-04	78-381030	498,00	78-381030	498,00	78-381302	377,00	78-381302	377,00
700 Sportsman 02 (after 5/1/02)	78-381030	498,00	78-381030	498,00				
700 Sportsman 02 (before 5/1/02)	78-381020	498,00	78-381020	498,00				
700 Sportsman EFI 4x4 07					78-381302	377,00	78-381302	377,00
700 Sportsman EFI 4x4 06	78-381335	397,00	78-381335	397,00	78-381302	377,00	78-381302	377,00
700 Sportsman EFI 4x4 05	78-381335	397,00	78-381335	397,00	78-381302	377,00	78-381302	377,00
700 Sportsman EFI 4x4 04	78-381030	498,00	78-381030	498,00	78-381302	377,00	78-381302	377,00
800 Ranger 4x4 13	78-383019	273,50	78-383019	273,50	78-383018	273,50	78-383018	273,50
800 Ranger 6x6 11-13	78-383019	273,50	78-383019	273,50	78-383018	273,50	78-383018	273,50
800 Ranger Crew 4x4 11-13	78-383019	273,50	78-383019	273,50	78-383018	273,50	78-383018	273,50
800 Ranger HD 4x4 11-12	78-383019	273,50	78-383019	273,50	78-383018	273,50	78-383018	273,50
800 Ranger XP 4x4 11-12	78-383019	273,50	78-383019	273,50	78-383018	273,50	78-383018	273,50
800 RZR 4x4 11-13	78-382975	273,50	78-382975	273,50	78-382976	273,50	78-382976	273,50
800 RZR 4x4 08-10	78-382975	273,50	78-382975	273,50	78-382976	273,50	78-382976	273,50
800 RZR 4 4x4 10-13	78-383028	273,50	78-383028	273,50	78-383027	273,50	78-383027	273,50
800 RZR S 4x4 09-13	78-383028	273,50	78-383028	273,50	78-383027	273,50	78-383027	273,50
800 Sportsman EFI 4x4 13					78-383023	273,50	78-383023	273,50
800 Sportsman EFI 4x4 11-12	78-383024	273,50	78-383024	273,50	78-383023	273,50	78-383023	273,50
800 Sportsman EFI 4x4 09-10	78-381038*	268,00	78-381038*	268,00	78-383022	273,50	78-383022	273,50
800 Sportsman EFI 4x4 08	78-381038*	268,00	78-381038*	268,00	78-383022	273,50	78-383022	273,50
800 Sportsman EFI 4x4 07	78-381038*	268,00	78-381038*	268,00	78-381302	377,00	78-381302	377,00
800 Sportsman EFI 4x4 06 GKN	78-381335	397,00	78-381335	397,00	78-381302	377,00	78-381302	377,00
800 Sportsman EFI 4x4 06 NEAPCO	78-381335	397,00	78-381335	397,00	78-381302	377,00	78-381302	377,00



TÄYDELLISET VETOAKSELIT JATKUU



POLARIS	EETEEN				TAAKSE			
	VASEN	HINTA	OIKEA	HINTA	VASEN	HINTA	OIKEA	HINTA
800 Sportsman EFI 4x4 05	78-381335	397,00	78-381335	397,00	78-381302	377,00	78-381302	377,00
800 Sportsman X2 4x4 07					78-381339	439,00	78-381339	439,00
850 Sportsman kaikki 11-13	78-383021	273,50	78-383021	273,50	78-383020	273,50	78-383020	273,50
900 RZR XP 4x4 12-13	78-383026	273,50	78-383026	273,50	78-383025	273,50	78-383025	273,50
900 RZR XP 4x4 11	78-383026	273,50	78-383026	273,50				
900 RZR XP 4 4x4 12-13	78-383026	273,50	78-383026	273,50	78-383025	273,50	78-383025	273,50
900 RZR XP LE EPS 4x4 13					78-383025	273,50	78-383025	273,50
Diesel 4x4 00-02	78-381000	439,00	78-381000	439,00	78-381301	397,00	78-381301	397,00
Diesel 4x4 99	78-381000	439,00	78-381000	439,00				

SUZUKI	EETEEN				TAAKSE			
	VASEN	HINTA	OIKEA	HINTA	VASEN	HINTA	OIKEA	HINTA
700 King Quad Auto 4x4 05-* *=-PUOLIKAS VETOAKSELI (SISEMPI NIVEL PUUTTUU)	78-381712	265,00	78-381712	265,00	78-380820	283,00	WE380820	283,00

YAMAHA	EETEEN				TAAKSE			
	VASEN	HINTA	OIKEA	HINTA	VASEN	HINTA	OIKEA	HINTA
250 Timberwolf 4x4 94-00	78-382978	377,00	78-382978	377,00				
350 Big Bear 4x4 98-99	78-382977	377,00	78-382977	377,00				
350 Big Bear 4x4 97 68AC	78-382978	377,00	78-382978	377,00				
350 Big Bear 4x4 97 68 LAC	78-382977	377,00	78-382977	377,00				
350 Big Bear 4x4 89-96	78-382978	377,00	78-382978	377,00				
350 Bruin 4x4 04-06	78-382985	377,00	78-382985	377,00				
350 Grizzly 4x4 09-11 IRS					78-382986	399,00	78-382986	399,00
350 Grizzly 4x4 07-08 IRS	78-382980	377,00	78-382981	377,00	78-382986	399,00	78-382986	399,00
350 Grizzly 4x4 07-08	78-382985	377,00	78-382985	377,00				
350 Wolverine 4x4 95-00	78-382977	377,00	78-382977	377,00				
400 Big Bear 4x4 07-08 w/IRS	78-382980	377,00	78-382981	377,00				
400 Big Bear 4x4 00-01 exc IRS	78-382977	377,00	78-382977	377,00				
400 Grizzly 4x4 07	78-382985	377,00	78-382985	377,00	78-382986	399,00	78-382986	399,00
400 Kodiak 4x4 05-06	78-382985	377,00	78-382985	377,00	78-382986	399,00	78-382986	399,00
400 Kodiak 4x4 03-04	78-382985	377,00	78-382985	377,00				
400 Kodiak 4x4 99	78-382977	377,00	78-382977	377,00				
400 Kodiak 4x4 93-98	78-382978	377,00	78-382978	377,00				
450 Grizzly 4x4 EPS 13								
450 Grizzly 4x4 EPS 11-12	78-382980	377,00	78-382981	377,00				
450 Grizzly 4x4 13								
450 Grizzly 4x4 09-12	78-382980	377,00	78-382981	377,00				
450 Grizzly 4x4 08	78-382980	377,00	78-382981	377,00	78-382986	399,00	78-382986	399,00
450 Grizzly 4x4 07	78-381305	377,00	78-381306	377,00	78-382986	399,00	78-382986	399,00
450 Kodiak 4x4 05-06	78-381305	377,00	78-381306	377,00	78-382986	399,00	78-382986	399,00
450 Kodiak 4x4 03-04	78-381305	377,00	78-381306	377,00				
450 Wolverine Sport 4x4 06-08	78-382985	377,00	78-382985	377,00				
550 Grizzly 4x4 EPS 09-11					78-382989	399,00	78-382989	399,00
660 Grizzly 4x4 03-08	78-381307	399,00	78-381309	399,00				
700 Grizzly 4x4 07-08	78-382988	399,00	78-382988	399,00	78-382989	399,00	78-382989	399,00
700 Rhino 08-13	78-382991	440,00	78-382991	440,00	78-381327	273,50	78-382992	440,00



Vanteet ja renkaat



Talvituoitteet



Vinsit



Laukut ja tuulisuojat



Sähköosat



Jousitus ja voimansiirto



Pakoputket ja suutinsarjat



Ohjaus



Rungon osat ja peitteet



Jarrupalat ja rattaat



Moottori



Variaattorin osat



Maatalous-tarvikkeet



Kärryt ja reet

VETONIVELET ULOMMAT JA SISEMMÄT: HINNASTO



Hinnasto	Hinnasto	Hinnasto	Hinnasto	Hinnasto	Hinnasto	Hinnasto
78-271000 151,50	78-271029 151,50	78-271049 151,50	78-271115 201,30	78-271138 139,00	78-271175 139,00	
78-271002 151,50	78-271030 151,50	78-271050 151,50	78-271116 201,30	78-271139 139,00	78-271176 139,00	
78-271003 151,50	78-271031 139,00	78-271051 151,50	78-271117 201,30	78-271140 139,00	78-271177 154,80	
78-271004 151,50	78-271032 151,50	78-271055 151,50	78-271118 201,30	78-271141 139,00	78-271178 154,80	
78-271007 151,50	78-271033 151,50	78-271057 151,50	78-271119 151,50	78-271142 151,50	78-271179 154,80	
78-271008 151,50	78-271034 151,10	78-271059 151,50	78-271121 151,50	78-271143 151,50	78-271180 154,80	
78-271009 151,50	78-271035 151,50	78-271060 151,50	78-271122 151,50	78-271147 139,00	78-271181 154,80	
78-271010 151,50	78-271036 151,50	78-271063 151,50	78-271123 151,50	78-271148 139,00	78-271182 154,80	
78-271011 151,50	78-271037 151,50	78-271065 151,50	78-271124 151,50	78-271150 139,00	78-271183 154,80	
78-271012 151,50	78-271038 151,50	78-271070 151,50	78-271125 151,50	78-271151 139,00	78-271184 154,80	
78-271013 151,50	78-271039 151,50	78-271072 151,50	78-271126 151,50	78-271153 167,90	78-271185 154,80	
78-271014 151,50	78-271040 151,50	78-271075 151,50	78-271127 151,50	78-271154 154,80	78-271186 154,80	
78-271015 151,50	78-271041 151,50	78-271080 151,50	78-271128 201,30	78-271157 154,80	78-271187 154,80	
78-271016 151,50	78-271042 151,50	78-271090 151,50	78-271129 201,30	78-271159 154,80	78-271188 154,80	
78-271017 151,50	78-271043 151,50	78-271094 151,50	78-271130 193,00	78-271160 154,80	78-271189 154,80	
78-271018 133,60	78-271044 151,50	78-271095 151,50	78-271131 193,00	78-271161 151,50	78-272050 201,30	
78-271020 151,50	78-271045 151,50	78-271110 151,50	78-271132 201,30	78-271164 139,00		
78-271024 151,50	78-271046 201,30	78-271111 151,50	78-271133 201,30	78-271171 232,40		
78-271025 151,50	78-271047 151,50	78-271112 201,30	78-271135 139,00	78-271172 154,80		
78-271026 151,50	78-271048 151,50	78-271114 201,30	78-271137 139,00	78-271173 154,80		

ATV

VETONIVELET ULOMMAT JA SISEMMÄT



ARCTIC CAT	Vuosi-malli	Eteen ulommat	Eteen Sisem-mät	Taakse Ulommat	Taakse Sisemmät
250 2x4	2005			78-271057	78-271135
250 2x4	2002-04			78-271060	78-271135
250 2x4 (inner race w/18 teeth)	2001			78-271050	
250 2x4 (inner race w/19 teeth)	2001			78-271060	78-271135
250 2x4	1999-00			78-271050	
250 4x4	2005	78-271057	78-271137	78-271057	78-271135
250 4x4	2002-04	78-271060	78-271137	78-271060	78-271135
250 4x4 (inner race w/18 teeth)	2001	78-271050		78-271050	
250 4x4 (inner race w/19 teeth)	2001	78-271060		78-271060	78-271135
300 2x4	2002			78-271060	78-271135
300 2x4 (inner race w/18 teeth)	2001			78-271050	
300 2x4 (inner race w/19 teeth)	2001			78-271060	78-271135
300 2x4	1998-00			78-271050	
300 4x4	2005	78-271057	78-271137	78-271057	78-271135
300 4x4	2002-04	78-271060	78-271137	78-271060	78-271135
300 4x4 (inner race w/18 teeth)	2001	78-271050		78-271050	
300 4x4 (inner race w/19 teeth)	2001	78-271060		78-271060	78-271135
300 4x4	1998-00			78-271050	
375 4x4	2002	78-271060	78-271137		
400 2x4	2002-04			78-271060	78-271137
400 4x4 exc FIS	2006-08	78-271041	78-271139	78-271041	78-271141
400 4x4 w/FIS	2006-08	78-271041	78-271140 (LT), 78-271139 (RT)	78-271041	78-271141
400 4x4 exc FIS	2005	78-271057	78-271137	78-271057	78-271141
400 4x4 w/FIS	2005	78-271041	78-271138 (LT), 78-271137 (RT)	78-271057	78-271141
400 4x4	2002-04	78-271060	78-271137	78-271060	78-271137
400 4x4 (inner race w/18 teeth)	2001	78-271050			
400 4x4 (inner race w/19 teeth)	2001	78-271060			
400 4x4	1998-00	78-271050			
454 4x4 (from #13001)	1998	78-271050			
454 4x4 (to #13000)	1998	78-271063			
454 4x4	1996-97	78-271063			
500 4x4	2007-08	78-271041	78-271140 (LT), 78-271139 (RT)	78-271041	78-271141
500 4x4 w/FIS	2006	78-271041	78-271140 (LT), 78-271139 (RT)	78-271041	78-271141
500 4x4 w/FIS	2005	78-271057	78-271138 (LT), 78-271137 (RT)	78-271057	78-271141
500 4x4	2003-04	78-271060	78-271137	78-271060	78-271137
500 4x4	2002	78-271060	78-271137		
500 4x4 (inner race w/18 teeth)	2001	78-271050			
500 4x4 (inner race w/19 teeth)	2001	78-271060			
500 4x4	1998-00	78-271050			
500 TBX 4x4	2006	78-271041	78-271140 (LT), 78-271139 (RT)	78-271041	78-271141
500 TRV 4x4	2006	78-271041	78-271139	78-271041	78-271141
650 4x4	2006-08	78-271041	78-271140 (LT), 78-271139 (RT)	78-271041	78-271141
650 4x4	2005	78-271057	78-271138 (LT), 78-271137 (RT)	78-271057	78-271141
650 4x4	2004	78-271060	78-271138 (LT), 78-271137 (RT)	-	-
650 H1 Prowler XT	2006-08	78-271041	78-271139 (LT), 78-271140 (RT)	78-271041	78-271141
700 EFI Auto 4x4	2007-08	78-271041	78-271140 (LT), 78-271139 (RT)	78-271041	78-271141
700 H1 EFI 4x4	2008	78-271041	78-271140 (LT), 78-271139 (RT)	78-271041	78-271141

CAN-AM	Vuosi-malli	Eteen ulommat	Eteen Sisem-mät	Taakse Ulommat	Taakse Sisemmät
330 Outlander 4x4	2004-05	78-271042		78-271124	
400 Outlander Std/XT 4x4	2011-12	78-271123	78-271176 (LT), 78-271175 (RT)		
400 Outlander Std/XT 4x4	2009-10	78-271123			
400 Outlander Std/XT 4x4	2006-08	78-271123		78-271124	
400 Outlander 4x4	2003-05	78-271042		78-271124	
400 Outlander Max Std/XT 4x4	2011-12	78-271123	78-271176 (LT), 78-271175 (RT)		
400 Outlander Max Std/XT 4x4	2009-10	78-271123			
400 Outlander Max Std/XT 4x4	2006-08	78-271123		78-271124	
500 Outlander Std/XT/XT-P 4x4	2011-12	78-271123	78-271176 (LT), 78-271175 (RT)	78-271173	
500 Outlander Std/XT/XT-P 4x4	2009-10	78-271123		78-271173	
500 Outlander Std/XT 4x4 w/10mm bands	2008	78-271123		78-271173	
500 Outlander 4x4	2007	78-271123		78-271125	
500 Outlander Max Std/XT/XT-P 4x4	2011-12	78-271123	78-271176 (LT), 78-271175 (RT)	78-271173	
500 Outlander Max Std/XT/XT-P 4x4	2009-10	78-271123		78-271173	
500 Outlander Max Std/XT 4x4 w/10mm bands	2008	78-271123		78-271173	
500 Outlander Max Ltd 4x4	2010	78-271123		78-271173	
500 Quest 4x4	2002-04	78-271122			
500 Renegade 4x4	2012	78-271123	78-271176 (LT), 78-271175 (RT)	78-271173	
500 Renegade 4x4	2011	78-271123		78-271173	
500 Renegade 4x4	2009-10	78-271123		78-271173	
500 Renegade 4x4 w/10 mm bands	2008	78-271123		78-271173	
650 Outlander Std/XT/XT-P 4x4	2011-12	78-271123	78-271176 (LT), 78-271175 (RT)	78-271173	
650 Outlander Std/XT/XT-P 4x4	2009-10	78-271123		78-271173	
650 Outlander Std/XT 4x4 w/10mm bands	2008	78-271123		78-271173	
650 Outlander 4x4	2006-07	78-271123		78-271125	
650 Outlander Max Std/XT/XT-P 4x4	2011-12	78-271123	78-271176 (LT), 78-271175 (RT)	78-271173	
650 Outlander Max Std/XT/XT-P 4x4	2009-10	78-271123		78-271173	
650 Outlander Max Std/XT 4x4 w/10mm bands	2008	78-271123		78-271173	
650 Quest 4x4	2002-04	78-271122			
800 Commander Std/XT	2011-12	78-271172		78-271173	
800 Outlander Std/XT/XT-P 4x4	2011-12	78-271123	78-271176 (LT), 78-271175 (RT)	78-271173	
800 Outlander Std/XT/XT-P 4x4	2009-10	78-271123		78-271173	
800 Outlander Std/XT 4x4 w/10mm bands	2008	78-271123		78-271173	
800 Outlander 4x4	2006-07	78-271123		78-271125	
800 Outlander Xmr 4x4	2011-12	78-271172		78-271173	
800 Outlander Xxc 4x4	2011	78-271123	78-271176 (LT), 78-271175 (RT)	78-271173	
800 Outlander Max Std/Ltd/XT/XT-P 4x4	2011-12	78-271123	78-271176 (LT), 78-271175 (RT)	78-271173	
800 Outlander Max Std/Ltd/XT/XT-P 4x4	2009-10	78-271123		78-271173	
800 Outlander Max Std/Ltd/XT 4x4 w/10mm bands	2008	78-271123	78-271176 (LT), 78-271175 (RT)	78-271173	
800 Renegade Std/Xxc 4x4	2012	78-271123	78-271176 (LT), 78-271175 (RT)	78-271173	





CAN-AM	Vuosi-malli	Eteen ulommat	Eteen Sisem-mät	Taakse Uloimmat	Taakse Sisemmät
800 Renegade Std/Xxc 4x4	2011	78-271123		78-271173	
800 Renegade Std/Xxc 4x4	2010	78-271123		78-271173	
800 Renegade Std/X 4x4	2009	78-271123		78-271173	
800 Renegade Std/X 4x4 w/10mm bands	2008	78-271123		78-271173	
800 Renegade 4x4	2007	78-271123		78-271125	
1000 Commander Ltd 4x4	2012	78-271172		78-271173	
1000 Commander Std/X/XT 4x4	2011-12	78-271172		78-271173	
1000 Outlander Std/XT 4x4	2012	78-271123		78-271173	
1000 Renegade Std/Xxc 4x4	2012	78-271123	78-271176 (LT), 78-271175 (RT)	78-271173	
Traxter 4x4	2002-05	78-271122			
Traxter 4x4 7459-60/7467/7468/7472/7481	2001	78-271122			
Traxter 4x4 exc 7459-60/7467/7468/7472/7481	2001	78-271121			
Traxter Autoshift 4x4 7431/7432	2001	78-271121			
Traxter Autoshift 4x4 exc 7431/7432	2001	78-271122			
Traxter Footshift 4x4 7439/7440	2001	78-271121			
Traxter Footshift 4x4 7473/7474	2001	78-271122			
Traxter XL 7448 from #v000709	2001	78-271122			
Traxter XL 7448 to #v000708	2001	78-271121			
Traxter XL 7467/7468/7472/7481/7489	2001	78-271122			
Traxter 4x4	1999-00	78-271121			

HONDA	Vuosi-malli	Eteen ulommat	Eteen Sisem-mät	Taakse Uloimmat	Taakse Sisemmät
TRX 300 Fourtrax 4x4	1988-00	78-271010			
TRX 350 D Foreman 4x4	1987-89	78-271010			
TRX 350 Fourtrax 4x4	1987	78-271010			
TRX 350 Rancher 4x4	2006	78-271010	78-271171		
TRX 350 Rancher 4x4	2000-05	78-271013			
TRX 400 Foreman 4x4	1995-03	78-271010			
TRX 400 Rancher 4x4	2004-07	78-271013			
TRX 400 Rancher 4x4	1995-03	78-271010			
TRX 420 Rancher 4x4 exc AT w/power steering	2009	78-271142			
TRX 420 Rancher ES 4x4	2007-08	78-271142			
TRX 450 Foreman 4x4	1998-04	78-271010			
TRX 500 Foreman 4x4	2008-13	78-271142	78-271171		
TRX 500 Foreman 4x4 exc ES w/power steering	2007	78-271070	78-271171		
TRX 500 Foreman ES 4x4 w/power steering	2007	78-271142	78-271171		
TRX 500 Foreman 4x4	2005-06	78-271070	78-271171		
TRX 500 Foreman ES 4x4 w/power steering	2008	78-271142	-		
TRX 500 Rubicon 4x4	2008-13	78-271142	78-271171		
TRX 500 Rubicon 4x4	2005-07	78-271070	78-271171		
TRX 500 Rubicon 4x4	2001-04	78-271070			
TRX 650 Rincon 4x4	2005	78-271070	78-271171	78-271072	
TRX 650 Rincon 4x4	2003-04	78-271070		78-271072	
TRX 680 Rincon 4x4	2010			78-271072	
TRX 680 Rincon 4x4	2008-13	78-271142	78-271171	78-271072	
TRX 680 Rincon 4x4	2006-07	78-271070	78-271171	78-271072	

KAWASAKI	Vuosi-malli	Eteen ulommat	Eteen Sisem-mät	Taakse Uloimmat	Taakse Sisemmät
300 Bayou 4x4	1989-04	78-271080			
300 Prairie 4x4	1999-02	78-271095			
360 Prairie 4x4	2009-12		78-271148 (LT), 78-271147 (RT)		
360 Prairie 4x4	2006-08	78-271094	78-271148 (LT), 78-271147 (RT)		
360 Prairie 4x4	2003-05	78-271090			
400 Bayou 4x4	1993-99	78-271080			
400 Prairie 4x4	1997-02	78-271080			
610 Mule 4x4 (400cc)	2010-12	78-271036	78-271147		
610 Mule 4x4 (400cc) from VIN # JK1AFAE9B547192	2009	78-271036	78-271147		
610 Mule 4x4 B136 (400cc) to VIN # JK1A-FAE9B547191	2009	78-271036			
610 Mule 4x4 (400cc)	2005-08	78-271036			
650 Brute Force 4x4	2005-12	78-271094	78-271148 (LT), 78-271147 (RT)		
650i Brute Force 4x4	2009-12	78-271008	78-271148 (LT), 78-271147 (RT)	78-271143	78-271151
650i Brute Force 4x4	2006-08	78-271008	78-271148 (LT), 78-271147 (RT)	78-271004	78-271150
650 Prairie 4x4	2002-03	78-271090			
700 Prairie 4x4	2004-06	78-271094	78-271148 (LT), 78-271147 (RT)		
750i Brute Force 4x4	2012	78-271008	78-271148 (LT), 78-271147 (RT)	78-271143	78-271151
750i Brute Force 4x4	2008-11	78-271161	78-271163 (RT)	78-271143	78-271151
750i Brute Force 4x4	2005-07	78-271008	78-271148 (LT), 78-271147 (RT)	78-271004	78-271150
750i Brute Force EPS 4x4	2012	78-271008	78-271148 (LT), 78-271147 (RT)	78-271143	78-271151
2510 Mule 4x4 (620cc)	1993-02	78-271110			
2510 Mule Diesel 4x4 (950cc)	1993-02	78-271110			
3010 Mule 4x4 (620cc)	2001-08	78-271110			
3010 Mule Diesel 4x4 (950cc)	2001-08	78-271110			
4010 Mule 4x4 (620cc)	2009-12	78-271164			
4010 Mule Diesel 4x4 (950cc)	2009-12	78-271164			

POLARIS	Vuosi-malli	Eteen ulommat	Eteen Sisem-mät	Taakse Uloimmat	Taakse Sisemmät
250 4x4/6x6	1993	78-272050			
250 4x4	1990	78-271012			
250 Big Boss 6x6 (BTB)	1992	78-271014			
250 Big Boss 6x6 (USA)	1992	78-272050			
250 Big Boss 6x6	1991	78-271014			
250 Trail Boss 4x4 (BTB)	1992	78-271014			
250 Trail Boss 4x4 (USA)	1992	78-272050			
250 Trail Boss 4x4	1991	78-272050			
250 Trail Boss 4x4	1989	78-271012			
250 Trail Boss 4x4	1988	78-271003			
250 Trail Boss 4x4	1987	78-271003			
(inner race has internal snap ring groove)					
250 Trail Boss 4x4	1987	78-271009			
(inner race has external snap ring groove)					
250 Xplorer 4x4	2000-02	78-271040			
300 4x4	1994/96	78-272050			
300 4x4	1995	78-271002			
300 6x6	1994	78-272050			
300 Hawkeye 2x4	2006-07			78-271051	78-271132
300 Hawkeye 4x4	2006-07	78-271051	78-271132	78-271051	78-271132
300 Sportsman 4x4	2008-10	78-271051	78-271132	78-271051	78-271132
300 Xplorer 4x4 (after 1/1/97)	1997-99	78-271020			
300 Xplorer 4x4 (before 1/1/97)	1996-97	78-271002			



Vanteet ja renkaat



Talvituotteet



Vinsit



Laukut ja tuulisuojat



Sähköosat



Jousitus ja voimansiirto



Pakoputket ja suutinsarjat



Ohjauksen osat



Rungon osat ja peitteet



Jarrupalat ja rattaat



Moottori



Variaattorin osat



Maatalous-tarvikkeet



Kärkyt ja reet

ATV





VETONIVELET ULOMMAT JA SISEMMÄT JATKUU



Vanteet ja renkaat



Talvituetteet



Vinssit



Laukut ja tuulisuojat



Sähköosat



Jousitus ja voimansiirto



Pakoputket ja suutinsarjat



Ohjaus



Rungon osat ja peitteet



Jarrupalat ja rattaat



Moottori



Variaattorin osat



Maatalous-tarvikkeet



Kärryt ja reet



ATV



ATV



ATV



ATV

POLARIS	Vuosi-malli	Eteen ulommat	Eteen Sisem-mät	Taakse Uloimmat	Taakse Sisemmät
325 Magnum 4x4 (exc HDS)	2000-02	78-271020			
325 Magnum 4x4 (HDS)	2001-02	78-271032			
325 Xpedition 4x4	2000-02	78-271020			
330 ATP 4x4	2005	78-271059	78-271128		
330 ATP 4x4	2004	78-271055			
330 Magnum 4x4	2005-06	78-271059	78-271128		
330 Magnum 4x4 (exc HDS)	2003-04	78-271055			
330 Magnum 4x4 (HDS)	2004	78-271044			
330 Magnum 4x4 (HDS)	2003	78-271032			
335 Sportsman 4x4 (some applications use u-joints)	2000	78-271020		78-271030	78-271034
335 Sportsman 4x4	1999	78-271020			
335 Sportsman 4x4	1995	78-271020			
335 Worker 4x4	1999	78-271020			
350 Sportsman 4x4	1993	78-272050			
350 Trail Boss 4x4 (BTB)	1992	78-271014			
350 Trail Boss 4x4 (USA)	1992	78-272050			
350 Trail Boss 4x4	1991	78-271014			
350L 4x4/6x6	1993	78-272050			
350L 4x4	1990-92	78-271014			
400 Hawkeye HO 2x4	2013			78-271177	78-271186
400 Hawkeye HO 4x4	2014			78-271177	78-271186
400 Scrambler 4x4	2000-02	78-271040			
400 Scrambler 4x4 (BTB)	1999	78-271020			
400 Scrambler 4x4 (USA)	1999	78-271040			
400 Scrambler 4x4	1998	78-271020			
400 Scrambler 4x4	1997	78-271002			
400 Scrambler 4x4 (BTB)	1995-96	78-271002			
400 Scrambler 4x4 (USA)	1995-96	78-271007			
400 Sportsman 4x4	2005	78-271059	78-271128	78-271075	78-271034
400 Sportsman 4x4	2004	78-271040		78-271075	78-271034
(w/female spline on Front Inboard yoke)					
400 Sportsman 4x4	2004	78-271055		78-271075	78-271034
(w/male spline on Front Inboard yoke)					
400 Sportsman 4x4	2003	78-271040		78-271075	78-271034
400 Sportsman 4x4	2002	78-271040		78-271030	78-271034
400 Sportsman 4x4	2001	78-271020		78-271030	78-271034
400 Sportsman 4x4	1997	78-271020			
400 Sportsman 4x4 (BTB)	1995-96	78-271002			
400 Sportsman 4x4 (USA)	1995-96	78-271007			
400 Sportsman 4x4	1994	78-272050			
400 Sportsman HO 4x4	2013-14			78-271177	78-271186
400 Sportsman HO 4x4	2011-12	78-271187	78-271183	78-271177	78-271186
400 Sportsman HO 4x4	2008-10	78-271051	78-271132	78-271051	78-271132
400 Xplorer 4x4	1999-02	78-271040			
400 Xplorer 4x4 (after 1/1/97)	1997-98	78-271020			
400 Xplorer 4x4 (before 1/1/97)	1997	78-271002			
400 Xplorer 4x4 (BTB)	1995-96	78-271002			
400 Xplorer 4x4 (USA)	1995-96	78-271007			
400L 4x4/6x6	1994	78-272050			
400L 6x6 (BTB)	1996	78-271020			
400L 6x6 (USA)	1996	78-271040			
400L 6x6 (BTB)	1995	78-271002			
400L 6x6 (USA)	1995	78-272050			
400L Big Boss 6x6 (after 1/1/97)	1997	78-271020			

POLARIS	Vuosi-malli	Eteen ulommat	Eteen Sisem-mät	Taakse Uloimmat	Taakse Sisemmät
400L Big Boss 6x6 (before 1/1/97)	1997	78-271002			
425 Magnum 4x4 (after 1/1/97)	1997-98	78-271020			
425 Magnum 4x4 (before 1/1/97)	1997	78-271002			
425 Magnum 4x4/6x6 (BTB)	1995-96	78-271002			
425 Magnum 4x4/6x6 (USA)	1995-96	78-271007			
425 Magnum 6x6 (after 1/1/97)	1997	78-271020			
425 Magnum 6x6 (before 1/1/97)	1997	78-271002			
425 Xpedition 4x4	2002	78-271040			
425 Xpedition 4x4	2000-10	78-271020			
450 Sportsman 4x4 (after 7/25/06)	2007	78-271043		78-271047	78-271034
450 Sportsman 4x4 (before 7/25/06)	2007	78-271044		78-271047	78-271034
450 Sportsman 4x4	2006	78-271044		78-271047	78-271034
500 ATP 4x4	2005	78-271059	78-271128		
500 ATP 4x4	2004	78-271055			
500 Big Boss 6x6	1998-99	78-271020			
500 Magnum 4x4 (HDS)	2003	78-271044			
500 Magnum 4x4 (exc HDS)	2002	78-271065			
500 Magnum 4x4 (HDS)	2001-02	78-271032			
500 Magnum 4x4 (exc HDS)	1999-01	78-271020			
500 Outlaw 2x4 (w/ IRS)	2006-07			78-271049	
500 Ranger 2x4	2008			78-271184	
500 Ranger 2x4	2005-07			78-271075	
500 Ranger 4x4	2006-07	78-271031	78-271128	78-271075	
500 Ranger 4x4	2005	78-271032		78-271075	
500 Ranger 4x4	2004	78-271032			
500 Ranger EFI 4x4	2008			78-271184	
500 Ranger EFI 4x4	2006-07	78-271031	78-271128	78-271075	
500 Ranger 6x6	2004-05	78-271065			
500 Scrambler 4x4	2011-12	78-271187	78-271183		
500 Scrambler 4x4	2010	78-271043			
500 Scrambler 4x4	1999-09	78-271040			
500 Scrambler 4x4 (after 1/1/97)	1997-98	78-271020			
500 Scrambler 4x4 (before 1/1/97)	1997	78-271002			
500 Sportsman 4x4	1999-01	78-271020		78-271030	78-271034
500 Sportsman 4x4	1998	78-271020			
500 Sportsman 4x4 (BTB)	1996	78-271002			
500 Sportsman 4x4 (USA)	1996	78-271007			
500 Sportsman 4x4	1995/97	78-271040			
500 Sportsman 6x6	2002-08	78-271040			
500 Sportsman 6x6	1999-01	78-271020			
500 Sportsman EFI 4x4	2008-09	78-271043		78-271184	78-271185
500 Sportsman EFI 4x4 (after 7/25/06)	2007	78-271043		78-271047	78-271034
500 Sportsman EFI 4x4 (before 7/25/06)	2007	78-271044		78-271047	78-271034
500 Sportsman EFI 4x4	2006	78-271044		78-271047	78-271034
500 Sportsman EFI Touring 4x4	2008-09	78-271043		78-271184	
500 Sportsman HO 4x4	2013			78-271177	78-271186
500 Sportsman HO 4x4	2011-12	78-271187	78-271183	78-271177	78-271186
500 Sportsman HO 4x4	2008-10	78-271043		78-271184	78-271185
500 Sportsman HO 4x4	2006	78-271044		78-271047	78-271034
500 Sportsman HO 4x4	2005	78-271059	78-271128	78-271075	78-271034
500 Sportsman HO 4x4	2004	78-271040		78-271075	78-271034
(w/female spline on Front Inboard yoke)					

VETONIVELET ULOMMAT JA SISEMMÄT JATKUU



POLARIS	Vuosi-malli	Eteen ulommat	Eteen Sisem-mät	Taakse Uloimmat	Taakse Sisemmät
500 Sportsman HO 4x4 (w/male spline on Front Inboard yoke)	2004	78-271055		78-271075	78-271034
500 Sportsman HO 4x4	2003	78-271040		78-271075	78-271034
500 Sportsman HO 4x4	2002	78-271040		78-271030	78-271034
500 Sportsman HO Touring 4x4	2013			78-271177	78-271178
500 Sportsman HO Touring 4x4	2011-12	78-271187	78-271183	78-271177	78-271178
500 Sportsman HO Touring 4x4	2010	78-271043		78-271184	
500 Sportsman X2 4x4	2009	78-271043		78-271184	78-271185
500 Sportsman X2 4x4	2008	78-271043		78-271184	
500 Sportsman X2 4x4 (after 7/25/06)	2006-07	78-271043		78-271047	78-271046
500 Sportsman X2 4x4 (before 7/25/06)	2006-07	78-271044		78-271047	78-271046
500 Worker 4x4	1999	78-271020		78-271030	78-271034
500 Xplorer 4x4	1997	78-271040			
525 Outlaw 2x4 (w/ IRS)	2007-11			78-271049	
550 Sportsman 4x4	2011-13	78-271182	78-271183	78-271179	78-271181
550 Sportsman 4x4 (after 11/17/09)	2010			78-271179	78-271181
550 Sportsman EPS 4x4	2013-14	78-271182	78-271183	78-271179	78-271181
550 Sportsman EPS 4x4	2012	78-271182	78-271183		
550 Sportsman LE w/ EPS 4x4	2013-14	78-271182	78-271183	78-271179	78-271181
550 Sportsman Touring 4x4	2011	78-271182	78-271183	78-271179	78-271181
550 Sportsman Touring 4x4	2010			78-271179	78-271181
550 Sportsman Touring EPS 4x4	2012-14	78-271182	78-271183	78-271179	78-271181
550 Sportsman X2 4x4	2011-14	78-271182	78-271183	78-271179	78-271181
550 Sportsman X2 4x4	2010			78-271179	78-271181
570 RZR 4x4	2012-14	78-271126	78-271133		
570 RZR EPS 4x4	2013	78-271126	78-271133		
570 RZR LE 4x4	2014	78-271126	78-271133		
570 Sportsman (Non EBS) 4x4	2014			78-271177	78-271186
570 Sportsman (EBS) 4x4	2014			78-271177	78-271186
570 Sportsman EPS (Non EBS) 4x4	2014			78-271177	78-271186
570 Sportsman EPS (EBS) 4x4	2014			78-271177	78-271186
570 Sportsman Touring 4x4	2014			78-271177	78-271186
600 Sportsman 4x4	2005	78-271059	78-271128	78-271075	78-271034
600 Sportsman 4x4	2003-04	78-271055		78-271075	78-271034
700 MV7 4x4 (after 7/25/06)	2007	78-271043		78-271047	78-271034
700 MV7 4x4 (before 7/25/06)	2006-07	78-271044		78-271047	78-271034
700 MV7 4x4	2005	78-271059		78-271075	
700 Ranger Crew 4x4	2008			78-271184	
700 Ranger EFI 6x6	2008			78-271184	
Malli	Vuosi-malli	Eteen ulommat	Eteen Sisem-mät	Keskiakseli Uloimmat	Keskiakseli Sisemmät
700 Ranger EFI 6x6	2006-07	78-271031	78-271128	78-271075	78-271129
Malli	Vuosi-malli	Eteen ulommat	Eteen Sisem-mät	Taakse Uloimmat	Taakse Sisemmät
700 Ranger XP 4x4	2008	-	-	78-271184	-
700 Ranger XP 4x4 (after 8/26/06)	2007	78-271031	78-271128	78-271047	78-271130 (LT), 78-271131 (RT)
700 Ranger XP 4x4 (before 8/26/06)	2007	78-271031	78-271128	78-271075	78-271130 (LT), 78-271131 (RT)

POLARIS	Vuosi-malli	Eteen ulommat	Eteen Sisem-mät	Taakse Uloimmat	Taakse Sisemmät
700 Ranger XP 4x4	2006	78-271031	78-271128	78-271075	78-271130 (LT), 78-271131 (RT)
700 Ranger XP 4x4	2005	78-271032	-	78-271075	78-271130 (LT), 78-271131 (RT)
700 Sportsman 4x4	2006	78-271044	-	78-271047	78-271034
700 Sportsman 4x4	2005	78-271059	78-271128	78-271075	78-271034
700 Sportsman 4x4	2003-04	78-271055	-	78-271075	78-271034
700 Sportsman 4x4 (after 5/1/02)	2002	78-271055	-	78-271033	78-271034
700 Sportsman 4x4 (before 5/1/02)	2002	78-271065	-	78-271033	78-271034
700 Sportsman EFI 4x4 (after 7/25/06)	2007	78-271043	-	78-271047	78-271034
700 Sportsman EFI 4x4 (before 7/25/06)	2007	78-271044	-	78-271047	78-271034
700 Sportsman EFI 4x4	2006	78-271044	-	78-271047	78-271034
700 Sportsman EFI 4x4	2005	78-271059	78-271128	78-271075	78-271034
700 Sportsman EFI 4x4	2004	78-271055	-	78-271075	78-271034
700 Sportsman X2 EFI 4x4	2008	78-271043	-	78-271184	-
800 Ranger 4x4	2013	78-271179	78-271180	78-271177	78-271178
800 Ranger 6x6	2011-14	78-271179	78-271180	78-271177	-
800 Ranger Crew 4x4	2011-14	78-271179	78-271180	78-271177	78-271178
800 Ranger Crew w/ EPS 4x4	2013	-	-	78-271177	78-271178
800 Ranger HD 4x4	2011-12	78-271179	78-271180	78-271177	78-271178
800 Ranger LE 4x4	2013	78-271179	78-271180	78-271177	78-271178
800 Ranger XP 4x4	2011-12	78-271179	78-271180	78-271177	78-271178
800 RZR 4x4	2011-13	78-271126	78-271133	78-271177	78-271189
800 RZR 4x4	2008-10	78-271126	78-271133	78-271127	
800 RZR 4x4 (w/EPS)	2012	78-271126	78-271133	78-271177	78-271189
800 RZR LE 4x4	2013	78-271126	78-271133	78-271177	78-271178
800 RZR LE w/EPS 4x4	2013	78-271126	78-271133	78-271177	78-271178
800 RZR 4 4x4	2011-14	78-271126	78-271133	78-271177	78-271189
800 RZR 4 4x4	2010	78-271126	78-271133	-	-
800 RZR 4 4x4 (w/EPS)	2012	78-271126	78-271133	78-271177	78-271189
800 RZR 4 LE (w/ EPS) 4x4	2013	78-271126	78-271133		
800 RZR S 4x4	2011-14	78-271126	78-271133	78-271177	78-271189
800 RZR S 4x4	2009-10	78-271126	78-271133	-	-
800 RZR S LE 4x4	2013-14	-	-	78-271177	78-271178
800 Sportsman 6x6	2013-14	-	-	78-271177	78-271186
800 Sportsman 6x6	2011-12	78-271187	78-271183	78-271177	78-271186
800 Sportsman 6x6	2009-10	78-271043	-	78-271184	78-271185
800 Sportsman EFI 4x4	2013-14	-	-	78-271177	78-271186
800 Sportsman EFI 4x4	2011-12	78-271187	78-271183	78-271177	78-271186
800 Sportsman EFI 4x4	2008-10	78-271043	-	78-271184	78-271185
800 Sportsman EFI 4x4 (after 7/25/06)	2007	78-271043	-	78-271047	-
800 Sportsman EFI 4x4 (before 7/25/06)	2007	78-271044	-	78-271047	-
800 Sportsman EFI 4x4	2006	78-271044	-	78-271047	78-271034
(stamped GKN on front outboard housing)					
800 Sportsman EFI 4x4 (stamped NEAPCO on front outboard housing)	2006	78-271059	78-271128	78-271047	78-271034
800 Sportsman EFI 4x4	2005	78-271059	78-271128	78-271075	78-271034
800 Sportsman EFI Touring 4x4	2010	78-271043	-	-	-
800 Sportsman EFI Touring 4x4	2008-09	78-271043	-	78-271184	-
800 Sportsman EFI X2 4x4	2009	78-271043	-	78-271184	-
800 Sportsman X2 4x4 (after 7/25/06)	2007	78-271043	-	78-271047	78-271046
800 Sportsman X2 4x4 (before 7/25/06)	2007	78-271044	-	78-271047	78-271046



Vanteet ja renkaat



Talvituotteet



Vinsit



Laukut ja tuulisuojat



Sähköosat



Jousitus ja voimansiirto



Pakoputket ja suutinsarjat



Ohjauksen osat



Runnon osat ja peitteet



Jarrupalat ja rattaat



Moottori



Variaattorin osat



Maatalous-tarvikkeet



Kärryt ja reet

ATV





VETONIVELET ULOMMAT JA SISEMMÄT JATKUU



Vanteet ja renkaat



Talvituotteet



Vinssit



Laukut ja tuulisuojat



Sähköosat



Jousitus ja voimansiirto



Pakoputket ja suutinsarjat



Ohjaukset



Rungon osat ja peitteet



Jarrupalat ja rattaat



Moottori



Variaattorin osat



Maataloustarvikkeet



Kärryt ja reet

POLARIS	Vuosi-malli	Eteen ulommat	Eteen Sisem-mät	Taakse Ulommat	Taakse Sisem-mät
850 Scrambler 4x4	2013-14	78-271182	78-271183	78-271179	78-271181
850 Scrambler LE 4x4	2013-14	78-271182	78-271183	78-271179	78-271181
850 Sportsman X2 4x4	2011	-	-	78-271179	78-271181
850 Sportsman XP 4x4	2011-14	78-271182	78-271183	78-271179	78-271181
850 Sportsman XP HO EPS 4x4	2012-13	78-271182	78-271183	78-271179	78-271181
850 Sportsman XP HO LE w/EPS 4x4	2013-14	78-271182	78-271183	78-271179	78-271181
850 Sportsman Touring HO EPS 4x4	2013-14	78-271182	78-271183	78-271179	78-271181
850 Sportsman Touring HO EPS 4x4	13-14	78-271182	78-271183	-	-
850 Sportsman Touring EPS 4x4	2011-12	78-271182	78-271183	78-271179	78-271181
850 Sportsman Touring EPS 4x4	2010	-	-	78-271179	78-271181
900 Ranger Diesel 4x4	2011-14	78-271179	-	78-271177	-
900 Ranger Diesel Crew 4x4	2012-14	78-271179	-	78-271177	-
900 Ranger XP 4x4	2013-14	78-271126	78-271133	78-271177	78-271178
900 Ranger XP LE 4x4	2013-14	78-271126	78-271133	78-271177	78-271178
900 Ranger Crew 4x4	2014	78-271126	78-271133	78-271177	78-271178
900 Ranger Crew LE 4x4	2014	78-271126	78-271133	78-271177	78-271178
900 RZR XP 4x4	2011-14	78-271188	78-271183	78-271177	78-271178
900 RZR XP LE 4x4	2013-14	78-271188	78-271183	78-271177	78-271178
900 RZR XP LE w/EPS 4x4	2013	78-271188	78-271183	-	-
900 RZR XP 4 4x4	2012-14	78-271188	78-271183	78-271177	78-271178
900 RZR XP 4 LE w/EPS 4x4	2013	78-271188	78-271183	78-271177	78-271178
1000 RZR XP 4x4	2014	78-271188	78-271183	-	-
Diesel 4x4	2000-02	78-271020	-	78-271030	78-271034
Diesel 4x4	1999	78-271020	-	-	-

SUZUKI	Vuosi-malli	Eteen ulommat	Eteen Sisem-mät	Taakse Ulommat	Taakse Sisem-mät
250 Quad Runner 4x4	1987-02	78-271011	-	-	-
300 King Quad 4x4	1991-02	78-271011	-	-	-
300 Quad Runner 4x4	1994-98	78-271011	-	-	-
400 Eiger 4x4	2002/05-07	78-271011	-	-	-
400 Eiger 4x4	2003-04	78-271011	-	-	-
(outboard housing marked 68 LAC)					
400 Eiger 4x4	2003-04	78-271016	-	-	-
(outboard housing marked UJ 68)					
500 Quad Master 4x4	2000-01	78-271011	-	-	-
500 Quad Runner 4x4	1998-01	78-271011	-	-	-
500 Vinson 4x4	2003-05	78-271016	-	-	-
500 Vinson Auto 4x4	2002/06	78-271011	-	-	-
620 QUV 4x4	2005	78-271110	-	-	-
700 King Quad 4x4	2005	78-271017	-	78-271018	-
700 Twin Peaks 4x4	2004-05	78-271094	-	-	-

YAMAHA	Vuosi-malli	Eteen ulommat	Eteen Sisem-mät	Taakse Ulommat	Taakse Sisem-mät
250 Timberwolf 4x4	1994-00	78-271000	-	-	-
350 Big Bear 4x4	1998-99	78-271000	-	-	-
350 Big Bear 4x4	1997	78-271000	-	-	-
(stamped 68 AC on Front Inboard housing)					
350 Big Bear 4x4	1997	78-271000	-	-	-
(stamped 68 LAC on Front Inboard housing)					
350 Big Bear 4x4	1989-96	78-271000	-	-	-
350 Big Bear 4x4	1987-88	78-271024	-	-	-
350 Bruin 4x4	2004-06	78-271026	78-271157	-	-
350 Grizzly 4x4 w/IRS	2008-10	78-271153	78-271114	-	78-271154
350 Grizzly 4x4 exc IRS	2012-13	78-271153	78-271114	-	-

YAMAHA	Vuosi-malli	Eteen ulommat	Eteen Sisem-mät	Taakse Ulommat	Taakse Sisem-mät
350 Grizzly 4x4 exc IRS	2009-11	-	78-271157	-	-
350 Grizzly 4x4 exc IRS	2007-08	78-271026	78-271157	-	-
350 Wolverine 4x4	2001-05	78-271026	-	-	-
350 Wolverine 4x4	1995-00	78-271000	-	-	-
400 Big Bear 4x4 w/IRS	2009-12	78-271153	78-271114	-	78-271154
400 Big Bear 4x4 w/IRS	2007-08	78-271153	78-271114	78-271048	78-271154
400 Big Bear 4x4 exc IRS	2002-06	78-271000	78-271157	-	-
400 Grizzly 4x4	2008	-	78-271157	-	78-271154
400 Grizzly 4x4	2007	78-271026	78-271157	78-271048	78-271154
400 Kodiak 4x4	2005-06	78-271026	78-271157	78-271048	78-271154
400 Kodiak 4x4	2000-04	78-271026	78-271157	-	-
400 Kodiak 4x4	1999	78-271000	-	-	-
400 Kodiak 4x4	1993-98	78-271000	-	-	-
450 Grizzly 4x4	2011-13	78-271153	78-271114	-	-
450 Grizzly 4x4	2009-10	78-271153	78-271114	-	78-271154
450 Grizzly 4x4	2008	78-271153	78-271114	78-271048	78-271154
450 Grizzly 4x4	2007	78-271026	78-271111 (LT)	78-271048	78-271154
450 Grizzly 4x4 w/EPS	2011-13	78-271153	78-271114	-	-
450 Kodiak 4x4	2005-06	78-271026	78-271111 (LT)	-	-
450 Kodiak 4x4	2003-04	78-271026	78-271114 (LT), 78-271112 (RT)	-	-
450 Rhino 4x4	2006	78-271037	-	78-271037	78-271118 (LT), 78-271116 (RT)
450 Wolverine 4x4	2009	-	78-271157	-	-
450 Wolverine Sport 4x4	2006-08	78-271026	78-271157	-	-
550 Grizzly 4x4	2013	-	-	-	78-271160
550 Grizzly 4x4	2012	78-271119	-	-	78-271160
550 Grizzly 4x4	2009-11	78-271119	78-271159	78-271119	78-271160
550 Grizzly 4x4 w/EPS	2013	-	-	-	78-271160
550 Grizzly 4x4 w/EPS	2012	78-271119	-	-	78-271160
550 Grizzly 4x4 w/EPS	2009-11	78-271119	78-271159	78-271119	78-271160
600 Grizzly 4x4	1999-01	78-271025	-	-	-
600 Grizzly 4x4	1998	78-271015	-	-	-
660 Grizzly 4x4	2004-08	78-271035	78-271112 (LT), 78-271114 (RT)	78-271035	78-271115 (LT), 78-271117 (RT)
660 Grizzly 4x4	2003	78-271035	78-271112 (LT)	78-271045	78-271115 (LT)
(stamped 68 LAC on front outboard housing)			78-271114 (RT)		78-271117 (RT)
660 Grizzly 4x4	2003	78-271045	78-271112 (LT)	78-271045	78-271115 (LT)
(stamped UJ 68 on front outboard housing)			78-271114 (RT)		78-271117 (RT)
660 Grizzly 4x4	2002	78-271026	78-271111 (LT)	78-271029	78-271116 (LT), 78-271118 (RT)
660 Rhino 4x4	2007	78-271037	78-271114 (LT), 78-271112 (RT)	78-271037	-
660 Rhino 4x4	2006	78-271037	78-271114 (LT), 78-271112 (RT)	78-271037	78-271118 (LT), 78-271116 (RT)
660 Rhino 4x4	2005	78-271038	78-271114 (LT), 78-271112 (RT)	78-271038	78-271118 (LT), 78-271116 (RT)
660 Rhino 4x4	2004	78-271039	78-271114 (LT), 78-271112 (RT)	78-271039	78-271117 (LT), 78-271115 (RT)
700 Grizzly 4x4	2007-14	78-271119	78-271159	78-271119	78-271160
700 Grizzly 4x4 w/EPS	2013	-	-	-	78-271160
700 Grizzly 4x4 w/EPS	2012	78-271119	-	-	78-271160
700 Grizzly 4x4 w/EPS	2008-11	78-271119	78-271159	78-271119	78-271160
700 Rhino 4x4	2008-13	-	-	78-271037	-
700 Rhino SE 4x4	2008	78-271037	78-271159	78-271037	-
700 Rhino Sport 4x4	2008-13	-	-	78-271037	-

ATV



Vanteet ja renkaat



Talvituotteet



Vinsit



Laukut ja tuulisuojat



Sähköosat



Jousitus ja voimansiirto



Pakoputket ja suutinsarjat



Ohjaus



Rungon osat ja peitteet



Jarrupalat ja rattaat



Moottori



Variaattorin osat



Maalaustarvikkeet



Kärryt ja reet



78-03085



78-03086



78-03087



78-03088



78-03090



78-08506



78-08511



78-08521



78-08525



78-08540



78-08541



78-08542



78-08543



78-08544



78-08545



78-08546



78-08547



78-08583



78-08585



78-08586



78-08587



78-08588



78-08593

Mittataulukko

Tuoteno.	Akselinhalk. mm	Ulkohalk. mm	Pituus mm	Hinta
78-03080	20,6	73	93	19,30
78-03081	19,3	66,5	104,5	19,30
78-03082	19,5	61,7	104	19,30
78-03083	19,8	64	96,3	19,30
78-03085	23,14	73,92	93,82	19,30
78-03076	22,5	67	111	19,30
78-03077	20	71	67	19,30
78-03078	24	77,5	97	19,30
78-03079	23	76	111	19,30
78-03086	18,43	65,69	93,82	19,30
78-03087	18,2	60,8	85	19,30
78-03088	19,9	62,6	97	19,30
78-03089	21	75	94	19,30
78-03090	18	61	83	19,30
78-08511	20,0	81,0	127,0	19,30
78-08512	17,0	56,8	85,50	19,30
78-08521	19,8	73,0	106,2	19,30
78-08525	17,8	56,5	79,9	19,30
78-08540	17,25	62,75	86,78	19,30
78-08541	25,0	78,04	95,1	19,30
78-08542	18,43	65,69	93,82	19,30
78-08543	20,39	75,98	98,33	19,30
78-08544	22,35	75,59	98,53	19,30

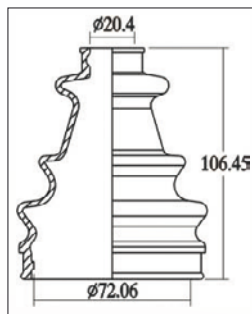

Tuoteno.	Akselinhalk. mm	Ulkohalk. mm	Pituus mm	Hinta
78-08545	18,9	66,0	100,0	19,30
78-08546	18,8	62,50	96,0	19,30
78-08547	19,31	65,29	88,71	19,30
78-08583	19,0	75,0	105,5	19,30
78-08585	19,5	66,5	109,4	19,30
78-08586	18,5	70,5	110,0	19,30
78-08587	20,4	72,06	106,45	19,30
78-08593	18,6	59,65	102,1	19,30
78-08583	18,9	77,9	105,3	19,30
78-08585	19,5	66,5	109,4	19,30
78-08586	18,3	69,5	108,2	19,30
78-08587	20,4	72,06	106,45	19,30
78-08593	18,6	59,65	102,1	19,30

BRONCO
ATV COMPONENTS



Suojakumien kiristystyökalu

Tuoteno	Hinta
78-400500	25,20

ATV





VETONIVELEN SUOJAKUMISARJAT

BRONCO
ATV COMPONENTS



Vanteet ja renkaat



Talvituotteet



Vinssit



Laukut ja tuulisuojat



Sähköosat



Jousitus ja voimansiirto



Pakoputket ja suutinsarjat



Ohjauk



Rungon osat ja peitteet



Jarrupalat ja rattaat



Moottori



Variaattorin osat



Maatalous-tarvikkeet



Kärryt ja reet

ARCTIC CAT		ETEEN				TAAKSE			
		ULOMPI	HINTA	SIEMPI	HINTA	ULOMPI	HINTA	SIEMPI	HINTA
250 2x4	1999-05			78-08521	19,30	78-08542	19,30	78-08542	19,30
250 4x4	2001-05	78-08542	19,30	78-08542	19,30	78-08542	19,30	78-08542	19,30
280 4x4	1998			78-08521	19,30	78-08521	19,30	-	
300 2x4	1998-03	-		78-08521	19,30	78-08542	19,30	78-08542	19,30
300 4x4	2001-05	78-08542	19,30	78-08542	19,30	78-08542	19,30	78-08542	19,30
300 4x4	1998-00	78-08542	19,30	78-08542	19,30				
371 4x4	1998			78-08521	19,30	78-08521	19,30		
375 4x4	2002	78-08542	19,30	78-08542	19,30	78-08521	19,30		
400 2x4	2003-05	78-08542	19,30	78-08542	19,30	78-08542	19,30	78-08542	19,30
400i 2x4	2002-					78-08542	19,30	78-08542	19,30
400 4x4	1999-10	78-08542	19,30	78-08542	19,30	78-08542	19,30	78-08542	19,30
400 4x4 FIS	1998-02			78-08521	19,30	78-08521	19,30	78-08521	19,30
400 ACT/Auto ACT 4x4	2003-04			78-08521	19,30	78-08521	19,30		
400 TBX 4x4	2002-06			78-08521	19,30	78-08521	19,30	78-08521	19,30
400 TRV 4x4	2006-10	78-08521	19,30	78-08521	19,30	78-08521	19,30	78-08521	19,30
400 VP/Auto VP 4x4	2005-06			78-08521	19,30	78-08521	19,30		
450 EFI	2010-11			78-08521	19,30	78-08521	19,30	78-08521	19,30
450 EFI/TRV/GT	2012-	78-03086	19,30	78-03086	19,30	78-03086	19,30	78-03086	19,30
454 4x4	1996-98	78-08540	19,30	78-08540	19,30	78-08521	19,30		
500 4x4	1998	78-08542	19,30	78-08542	19,30	78-08521	19,30		
500 4x4 FIS	2002-09	78-08542	19,30	78-08542	19,30	78-08542	19,30	78-08542	19,30
500 Core	2013-	78-03086	19,30	78-03086	19,30	78-03086	19,30	78-03086	19,30
500 TBX 4x4	2003-06	78-08542	19,30	78-08542	19,30	78-08521	19,30	78-08521	19,30
500 TRV 4x4	2004-08	78-08542	19,30	78-08542	19,30	78-08521	19,30	78-08521	19,30
550 Core	2013-	78-03086	19,30	78-03086	19,30	78-03086	19,30	78-03086	19,30
550 H1,EFI	2009-10	78-08542	19,30	78-08542	19,30	78-08521	19,30	78-08521	19,30
550 H1	2011	78-03086	19,30	78-03086	19,30	78-03085	19,30	78-03085	19,30
550 H1 Prowler 4x4	2009-10	78-08542	19,30	78-08542	19,30	78-08542	19,30	78-08542	19,30
550 H1 Prowler XT 4x4	2011-13	78-03086	19,30	78-03086	19,30	78-03086	19,30	78-03086	19,30
550 TRV	2011-13	78-03086	19,30	78-03086	19,30	78-03085	19,30	78-03085	19,30
650 H1 4x4	2005-10	78-08542	19,30	78-08542	19,30	78-08521	19,30	78-08521	19,30
650 H1 4x4	2011	78-03086	19,30	78-03086	19,30	78-03086	19,30	78-03086	19,30
650 H1 4x4	2012-13	78-03086	19,30	78-03086	19,30	78-03085	19,30	78-03085	19,30
650 H1 Prowler 4x4	2006-08	78-08542	19,30	78-08542	19,30	78-08542	19,30	78-08542	19,30
650 MUD PRO	2010	78-03085	19,30	78-03085	19,30	78-03085	19,30	78-03085	19,30
650 MUD PRO	2011	78-08542	19,30	78-08542	19,30	78-03085	19,30	78-03085	19,30
650 TBX 4x4	2007-09	78-08542	19,30	78-08542	19,30	78-08521	19,30	78-08521	19,30
650 TRV 4x4	2007-10	78-08542	19,30	78-08542	19,30	78-08521	19,30	78-08521	19,30
650 V2 4x4	2004-06	78-08542	19,30	78-08542	19,30	78-08542	19,30	78-08542	19,30
700 Core	2013	78-03086	19,30	78-03086	19,30	78-03086	19,30	78-03086	19,30
700 Diesel 4x4	2007-10	78-08542	19,30	78-08542	19,30	78-08542	19,30	78-08542	19,30
700 Diesel 4x4	2011-12	78-03086	19,30	78-03086	19,30	78-03086	19,30	78-03086	19,30
700 EFI Auto 4x4	2006-09	78-08542	19,30	78-08542	19,30	78-08542	19,30	78-08542	19,30
700 EFI Auto 4x4	2011	78-03086	19,30	78-03086	19,30	78-03085	19,30	78-03085	19,30
700 EFI Auto 4x4	2012	78-03086	19,30	78-03086	19,30	78-03086	19,30	78-03086	19,30
700 H1 EFI 4x4	2008-10	78-08542	19,30	78-08542	19,30	78-08542	19,30	78-08542	19,30
700 H1 Prowler 4x4	2008-11	78-08542	19,30	78-08542	19,30	78-08542	19,30	78-08542	19,30
700 MUD PRO	2009-10	78-08542	19,30	78-08542	19,30	78-08542	19,30	78-08542	19,30
700 MUD PRO	2011-12	78-03085	19,30	78-03085	19,30	78-03085	19,30	78-03085	19,30
700 MUD PRO	2013	78-03085	19,30	78-03085	19,30				
700 PROWLER XT	2009-10	78-08542	19,30	78-08542	19,30	78-08542	19,30	78-08542	19,30
700 PROWLER XT/HDX	2011-13	78-03086	19,30	78-03086	19,30	78-03086	19,30	78-03086	19,30
700 TBX 4x4	2010	78-08542	19,30	78-08542	19,30	78-08542	19,30	78-08542	19,30
700 TBX 4x4	2011	78-03086	19,30	78-03086	19,30	78-03086	19,30	78-03086	19,30
700 TRV 4x4	2008-10	78-08542	19,30	78-08542	19,30	78-08542	19,30	78-08542	19,30
700 TRV 4x4	2011	78-03086	19,30	78-03086	19,30	78-03086	19,30	78-03086	19,30
1000 MUD PRO	2010	78-08542	19,30	78-08542	19,30				
1000 MUD PRO	2011	78-03085	19,30	78-03085	19,30	78-03085	19,30	78-03085	19,30
1000 Prowler XTZ 4x4	2009-10	78-08542	19,30	78-08542	19,30	78-08542	19,30	78-08542	19,30
1000 Prowler XTZ 4x4	2011-13	78-03086	19,30	78-03086	19,30	78-03086	19,30	78-03086	19,30
1000 TRV 4x4	2009-10	78-08542	19,30	78-08542	19,30	78-08542	19,30	78-08542	19,30

CAN-AM		ETEEN				TAAKSE			
		ULOMPI	HINTA	SIEMPI	HINTA	ULOMPI	HINTA	SIEMPI	HINTA
330 HO Outlander 2x4	2003-05	78-08521	19,30	78-08521	19,30	78-08586	19,30	78-08547	19,30
330 HO Outlander 4x4	2003-05	78-08525	19,30	78-08541	19,30	78-08586	19,30	78-08547	19,30
400 HO Outlander 4x4	2003-05	78-08525	19,30	78-08541	19,30	78-08586	19,30	78-08547	19,30
400 HO Outlander ,Max 4x4	2006-08	78-08545	19,30	78-08546	19,30	78-08586	19,30	78-08547	19,30
400 HO Outlander Max/STD/XT	2009-12	78-08545	19,30	78-08546	19,30				
400 HO Outlander XT	2006-07	78-08545	19,30	78-08546	19,30	78-08586	19,30	78-08547	19,30
400 HO Outlander Max XT	2006-07	78-08545	19,30	78-08546	19,30	78-08586	19,30	78-08547	19,30
500 HO Outlander EFI/XT 4x4	2007-10	78-08545	19,30	78-08546	19,30	78-08583	19,30	78-08583	19,30
500 HO Outlander EFI Max/XT 4x4	2007	78-08545	19,30	78-08546	19,30	78-08583	19,30	78-08583	19,30
500 HO Outlander EFI Max/XT 4x4	2008-12	78-08545	19,30	78-08546	19,30	78-03079	19,30	78-03079	19,30
500 Quest 4x4	2002-04	78-08525	19,30	78-08541	19,30	78-08521	19,30	78-08521	19,30
500 Quest XL 4x4	2002	78-08525	19,30	78-08541	19,30	78-08521	19,30	78-08521	19,30

ATV





CAN-AM									
		ETEEN				TAAKSE			
		ULOMPI	HINTA	SISEMPI	HINTA	ULOMPI	HINTA	SISEMPI	HINTA
500 Renegade 4x4	2008-12	78-08545	19,30	78-08546	19,30	78-08521	19,30	78-08521	19,30
500 Traxter 4x4	1999-05	78-08525	19,30	78-08541	19,30	78-08521	19,30	78-08521	19,30
500 Traxter XL 4x4	2002-05	78-08525	19,30	78-08541	19,30	78-08521	19,30	78-08521	19,30
500 Traxter Max 4x4	2003-04	78-08525	19,30	78-08541	19,30	78-08521	19,30	78-08521	19,30
650 HO Outlander EFI/XT 4x4	2007-11	78-08545	19,30	78-08546	19,30	78-08583	19,30	78-08583	19,30
650 HO Outlander EFI Max/Max XT	2007-11	78-08545	19,30	78-08546	19,30	78-08583	19,30	78-08583	19,30
650 HO Outlander STD/XT 4x4	2008-12	78-08545	19,30	78-08546	19,30	78-03079	19,30	78-03079	19,30
650 Quest 4x4	2002-04	78-08525	19,30	78-08541	19,30	78-08521	19,30	78-08521	19,30
650 Quest Max 4x4	2004	78-08525	19,30	78-08541	19,30	78-08521	19,30	78-08521	19,30
650 Traxter Auto 4x4	2005	78-08525	19,30	78-08541	19,30	78-08521	19,30	78-08521	19,30
650 Traxter Max Auto 4x4	2005	78-08525	19,30	78-08541	19,30	78-08521	19,30	78-08521	19,30
800 Commander STD/XT	2011-12	78-08545	19,30	78-08546	19,30	78-03079	19,30	78-03079	19,30
800 HO Outlander EFI	2006-12	78-08545	19,30	78-08546	19,30	78-08583	19,30	78-08583	19,30
800 HO Outlander EFI XT	2006-12	78-08545	19,30	78-08546	19,30	78-08583	19,30	78-08583	19,30
800 HO Outlander EFI Max/Max XT	2006-12	78-08545	19,30	78-08546	19,30	78-08583	19,30	78-08583	19,30
800 Renegade/Renegade X 4x4	2007-12	78-08545	19,30	78-08546	19,30	78-08583	19,30	78-08583	19,30
1000 Commander	2011-12	78-08545	19,30	78-08546	19,30	78-03079	19,30	78-03079	19,30
HONDA									
		ETEEN				TAAKSE			
		ULOMPI	HINTA	SISEMPI	HINTA	ULOMPI	HINTA	SISEMPI	HINTA
300 TRX 4x4	1988-00	78-08540	19,30	78-08521	19,30				
350 Fourtrax Rancher 4x4	2000-06	78-08540	19,30	78-08593	19,30				
350 Fourtrax Rancher ES 4x4	2000-06	78-08540	19,30	78-08593	19,30				
350 TRX 4x4	1986-89	78-08540	19,30	78-08521	19,30				
400 Fourtrax Foreman 4x4	1995-05	78-08521	19,30	78-08521	19,30				
400 Fourtrax Rancher 4x4	2004-09	78-08521	19,30	78-08521	19,30				
420 Fourtrax Rancher 4x4	2007-13	78-08540	19,30	78-08525	19,30				
450 TRX 4x4	1998-04	78-08540	19,30	78-08593	19,30				
475 Fourtrax Foreman / ES 4x4	2005-11	78-08521	19,30	78-08521	19,30				
500 TRX Foreman	2005-06	78-08542	19,30	78-08525	19,30				
500 TRX Foreman	2007	78-08540	19,30	78-08525	19,30				
500 TRX Foreman	2008-13	78-08540	19,30	78-08525	19,30				
500 TRX Rubicon 4x4	2001-04	78-08521	19,30	78-08593	19,30				
500 TRX Rubicon 4x4	2005-07	78-08542	19,30	78-08525	19,30				
500 TRX Rubicon 4x4	2008-13	78-08540	19,30	78-08525	19,30				
650 TRX Rincon 4x4	2003-05	78-08521	19,30	78-08525	19,30	78-08521	19,30	78-08521	19,30
650 TRX Rincon GPScape 4x4	2005	78-08521	19,30	78-08525	19,30	78-08521	19,30	78-08521	19,30
680 Rincon 4x4	2006-07	78-08542	19,30	78-08525	19,30	78-08547	19,30	78-08547	19,30
680 Rincon GPScape 4x4	2008-13	78-08540	19,30	78-08525	19,30	78-08547	19,30	78-08547	19,30
KAWASAKI									
		ETEEN				TAAKSE			
		ULOMPI	HINTA	SISEMPI	HINTA	ULOMPI	HINTA	SISEMPI	HINTA
300 Bayou 4x4	1989-04	78-08540	19,30	78-08593	19,30				
300 Prairie 4x4	1999-02	78-08540	19,30	78-08540	19,30				
360 Prairie 4x4	2003-11	78-08540	19,30	78-08525	19,30				
400 Bayou 4x4	1993-99	78-08540	19,30	78-08593	19,30				
400 Prairie 4x4	1997-02	78-08540	19,30	78-08540	19,30				
610 Mule All 4x4 (400cc)	2010-14	78-08545	19,30	78-08525	19,30				
650i Brute Force 4x4	2006-08	78-08542	19,30	78-08525	19,30	78-08542	19,30	78-08547	19,30
650i Brute Force 4x4	2009-13	78-08545	19,30	78-08525	19,30	78-03076	19,30	78-03076	19,30
650 Brute Force 4x4	2004-09	78-08540	19,30	78-08525	19,30				
650 Brute Force 4x4	2010-13			78-08525	19,30				
650 Prairie 4x4	2002-03	78-130118	29,70	78-130119	29,70				
700 Prairie 4x4	2004-06	78-130118	29,70	78-130119	29,70				
750i Brute Force 4x4	2005-07	78-08542	19,30	78-08525	19,30	78-08542	19,30	78-08547	19,30
750i Brute Force 4x4	2008-11	78-08545	19,30	78-08546	19,30	78-03076	19,30	78-08542	19,30
750i Brute Force 4x4	2012-14	78-08545	19,30	78-08525	19,30	78-03076	19,30	78-08542	19,30
750 Teryx 4x4	2008					78-03077	19,90	78-03078	19,30
750 Teryx 4x4	2009-11	78-03076	19,30	78-08525	19,30	78-03077	19,90	78-03078	19,30
750 Teryx 4x4	2012-13	78-03076	19,30	78-08525	19,30				
2010 Mule All 4x4 (540cc)		78-08540	19,30						
2510 Mule All 4x4 (620cc)		78-08540	19,30	78-08593	19,30				
2510 Mule Diesel All 4x4 (950cc)		78-08540	19,30	78-08593	19,30				
3010 Mule All 4x4 (620cc)		78-08540	19,30	78-08593	19,30				
3010 Mule Diesel All 4x4 (950cc)		78-08540	19,30	78-08593	19,30				
4010 Mule 4x4 09-13 (620cc)		78-08521	19,30	78-08525	19,30				
4010 Mule Diesel 4x4 09-10 (650cc)		78-08521	19,30	78-08525	19,30				
KYMCO									
		ETEEN				TAAKSE			
		ULOMPI	HINTA	SISEMPI	HINTA	ULOMPI	HINTA	SISEMPI	HINTA
375 MAXXER IRS	2009-11	78-08521	19,30	78-08521	19,30	78-08521	19,30	78-08521	19,30
450i MAXXER	2011	78-08521	19,30	78-08521	19,30	78-08521	19,30	78-08521	19,30
500 MXU 4x4	2006-07	78-08541	19,30	78-08521	19,30				
500 MXU IRS	2008-11	78-08521	19,30	78-08521	19,30	78-08521	19,30	78-08521	19,30



Vanteet ja renkaat



Talvituet



Vinsit



Laukut ja tuulisuojat



Sähköosat



Jousitus ja voimansiirto



Pakoputket ja suutinsarjat



Ohjaus



Rungon osat ja peitteet



Jarrupalat ja rattaat



Moottori



Variaattorin osat



Maatalous-tarvikkeet



Kärryt ja reet

ATV





VETONIVELEN SUOJAKUMISARJAT JATKUU



Vanteet ja renkaat



Talvituuotteet



Vinssit



Laukut ja tuulisuojat



Sähköosat



Jousitus ja voimansiirto



Pakoputket ja suutinsarjat



Ohjaus



Rungon osat ja peitteet



Jarrupalat ja rattaat



Moottori



Variaattorin osat



Maatalous-tarvikkeet



Kärryt ja reet

POLARIS		ETEEN				TAAKSE			
		ULOMPI	HINTA	SISEMPI	HINTA	ULOMPI	HINTA	SISEMPI	HINTA
250 Big Boss 4x6	1989-92	78-08586	19,30						
250 Big Boss 6x6	1991-93	78-08586	19,30						
250 Trail Boss 4x4	1985-99	78-08587	19,30						
250 Xplorer 4x4	2000-02	78-08587	19,30						
300 4x4	1994-95	78-08587	19,30						
300 Big Boss 6x6	1994	78-08587	19,30						
300 Hawkeye 2x4	2006-07					78-08540	19,30	78-08540	19,30
300 Hawkeye 4x4	2006-07	78-08540	19,30	78-08540	19,30	78-08540	19,30	78-08540	19,30
300 Sportsman 4x4	2008-10	78-08540	19,30	78-08540	19,30	78-08540	19,30	78-08540	19,30
300 Xplorer 4x4	1996-99	78-08586	19,30						
325 Magnum 4x4	2000-02	78-08586	19,30						
325 Xpedition 4x4	2000-02	78-08586	19,30						
330 ATP 4x4	2004-05	78-08587	19,30	78-08585	19,30				
330 Magnum 4x4	2003-06	78-08587	19,30	78-08585	19,30				
335 Sportsman 4x4	1999-00	78-08586	19,30			78-08543	19,30	78-08544	19,30
350 Big Boss 6x6	1993	78-08586	19,30						
350 Trail Boss 4x4	1991-93	78-08587	19,30						
400 4x4	1994	78-08587	19,30						
400 Big Boss 6x6	1994-97	78-08587	19,30						
400 Hawkeye HO 4x4	2014-	78-03080	19,30	78-03083	19,30				
400 Ranger 4x4	2010-14	78-08585	19,30	78-08585	19,30	78-08583	19,30	78-08583	19,30
400 Scrambler 4x4	1995-00	78-08587	19,30						
400 Sportsman HO 4x4	2011-12	78-03080	19,30	78-03083	19,30	78-03080	19,30	78-03083	19,30
400 Sportsman HO 4x4	2013-14	78-03082	19,30	78-03082	19,30	78-03080	19,30	78-03083	19,30
400 Sportsman 4x4	2005-10	78-08540	19,30	78-08540	19,30	78-08540	19,30	78-08540	19,30
400 Sportsman 4x4	2001-04	78-08587	19,30	78-08585	19,30	78-08543	19,30	78-08544	19,30
400 Sportsman 4x4	1994-00	78-08587	19,30						
400 Xplorer 4x4	1995-02	78-08587	19,30						
425 Xpedition 4x4	2000-02	78-08587	19,30						
425 Magnum 4x4	1995-98	78-08586	19,30						
425 Magnum 6x6	1996-98	78-08586	19,30						
450 Sportsman 4x4	2006-07	78-08586	19,30	78-08547	19,30	78-08583	19,30	78-08583	19,30
455 Diesel 4x4	1999-01								
500 ATP 4x4	2004-05	78-08587	19,30	78-08585	19,30	-		-	
500 Big Boss 6x6	1998-99	78-08586	19,30	-		-		-	
500 Magnum 4x4	1999-02	78-08586	19,30	-		-		-	
500 Outlaw 4x4	2006-07	-		-		78-08587	19,30	-	
500 Ranger 2x4	2007	-		-		78-08587	19,30	78-08587	19,30
500 Ranger 4x4	2006-07	78-08587	19,30	78-08585	19,30	78-08583	19,30	78-08583	19,30
500 Ranger 4x4	2005-05	78-08586	19,30	78-08547	19,30	78-08583	19,30	78-08583	19,30
500 Ranger 6x6	2005	78-08587	19,30						
500 Ranger 6x6	2004	78-08587	19,30						
500 Ranger EFI/Crew	2011-13	78-08585	19,30	78-08585	19,30	78-08583	19,30	78-08583	19,30
500 Ranger EFI 4x4	2006-11	78-08545	19,30	78-08546	19,30	78-08521	19,30	78-08521	19,30
500 Scrambler 4x4	1997-10	78-08587	19,30						
500 Sportsman 4x4	1998-02	78-08586	19,30			78-08543	19,30	78-08544	19,30
500 Sportsman 4x4	1996-97	78-08586	19,30						
500 Sportsman 6x6	2000-07	78-08587	19,30						
500 Sportsman EFI Touring 4x4	2008-11	78-08545	19,30	78-08546	19,30	78-08521	19,30	78-08521	19,30
500 Sportsman HO Touring 4x4	2010	78-08545	19,30	78-08546	19,30	78-08521	19,30	78-08521	19,30
500 Sportsman EFI 4x4	2006-09	78-08545	19,30	78-08546	19,30	78-08521	19,30	78-08521	19,30
500 Sportsman HO 4x4	2013	78-03082	19,30	78-03082	19,30	78-03080	19,30	78-03083	19,30
500 Sportsman HO 4x4	2011-12	78-03080	19,30	78-03083	19,30	78-03080	19,30	78-03083	19,30
500 Sportsman HO 4x4	2008-10	78-08545	19,30	78-08546	19,30	78-03079	19,30	78-03079	19,30
500 Sportsman HO 4x4	2006-07	78-08586	19,30	78-08547	19,30	78-08583	19,30	78-08583	19,30
500 Sportsman HO 4x4	2005	78-08587	19,30	78-08585	19,30	78-08541	19,30	78-08541	19,30
500 Sportsman HO 4x4	2001-04	78-08587	19,30	-		78-08541	19,30	78-08544	19,30
500 Sportsman X2 4x4	2006	78-08545	19,30	78-08546	19,30	78-08521	19,30	78-08521	19,30
500 Sportsman X2 EFI 4x4	2007-09	78-08545	19,30	78-08546	19,30	78-03079	19,30	78-03079	19,30
500 Xplorer 4x4	1997					78-08587	19,30		
550 Sportsman XP 4x4	2011-14	78-03082	19,30	78-03083	19,30	78-03081	19,30	78-03081	19,30
550 Sportsman XP 4x4	2009-10	78-08545	19,30	78-08546	19,30	78-08521	19,30	78-08521	19,30
550 Sportsman X2 4x4	2010-11	78-08545	19,30	78-08546	19,30	78-08521	19,30	78-08521	19,30
570 Sportsman	2014-	78-03082	19,30	78-03083	19,30	78-03080	19,30	78-03083	19,30
600 Sportsman 4x4	2005	78-08587	19,30	78-08521	19,30	78-08521	19,30	78-08521	19,30
600 Sportsman 4x4	2003-04	78-08587	19,30	78-08521	19,30	78-08521	19,30	78-08521	19,30
700 MV7 4x4	2005	78-08521	19,30	78-08521	19,30	78-08521	19,30	78-08521	19,30
700 Ranger Ranger Crew 4x4	2008-09	78-08585	19,30	78-08585	19,30	78-03079	19,30	78-03079	19,30
700 Ranger EFI 6x6	2006-07	78-08521	19,30	78-08521	19,30	-		-	
700 Ranger XP 4x4	2005-09	78-08521	19,30	78-08521	19,30	78-08521	19,30	78-08521	19,30
700 Sportsman 4x4	2005	78-08521	19,30	78-08521	19,30	78-08521	19,30	78-08521	19,30
700 Sportsman 4x4	2002-04	78-08521	19,30			78-08521	19,30	78-08521	19,30

ATV

VETONIVELEN SUOJAKUMISARJAT JATKUU



Vanteet ja renkaat



Talvituotteet



Vinsit



Laukut ja tuulisuojat



Sähköosat



Jousitus ja voimansiirto



Pakoputket ja suutinsarjat



Ohjaus



Rungon osat ja peitteet



Jarrupalat ja rattaat



Moottori



Variaattorin osat



Maatalous-tarvikkeet



Kärryt ja reet

ATV



POLARIS		ETEEN				TAAKSE			
		ULOMPI	HINTA	SIEMPI	HINTA	ULOMPI	HINTA	SIEMPI	HINTA
700 Sportsman EFI 4x4	2005-07	78-08521	19,30	78-08521	19,30	78-08521	19,30	78-08521	19,30
700 Sportsman EFI 4x4	2004	78-08521	19,30			78-08521	19,30	78-08521	19,30
700 Sportsman EFI X2 4x4	2008-09	78-08521	19,30	78-08521	19,30	78-08521	19,30	78-08521	19,30
700 Sportsman EFI 4x4	2004	78-08521	19,30			78-08521	19,30	78-08521	19,30
800 Big Boss 6x6	2010-11	78-08521	19,30	78-08521	19,30				
800 Ranger Crew 4x4	2010-12	78-03081	19,30	78-03081	19,30	78-03080	19,30	78-03083	19,30
800 Ranger Crew EPS 4x4	2012-13	78-03081	19,30	78-03081	19,30	78-03080	19,30	78-03083	19,30
800 Ranger XP 4x4	2010-11	78-08521	19,30	78-08521	19,30	78-08521	19,30	78-08521	19,30
800 RZR 4x4	2011-14	78-08585	19,30	78-08585	19,30	78-03080	19,30	78-03083	19,30
800 RZR S 4x4	2009-10	78-08585	19,30	78-08585	19,30	78-03079	19,30	78-03079	19,30
800 Sportsman EFI 4x4	2013-14	78-03082	19,30	78-03082	19,30	78-03080	19,30	78-03083	19,30
800 Sportsman EFI 4x4	2011-12	78-03080	19,30	78-03083	19,30	78-03080	19,30	78-03083	19,30
800 Sportsman EFI 4x4	2005-10	78-08521	19,30	78-08521	19,30	78-08521	19,30	78-08521	19,30
800 Sportsman EFI X2 4x4	2007	78-08521	19,30	78-08521	19,30	78-08521	19,30	78-08521	19,30
850 Sportsman XP 4x4	2009-11	78-08521	19,30	78-08521	19,30	78-08521	19,30	78-08521	19,30
850 Sportsman XP 4x4	2012-14	78-03082	19,30	78-03083	19,30	78-03081	19,30	78-03081	19,30
SUZUKI		ETEEN				TAAKSE			
		ULOMPI	HINTA	SIEMPI	HINTA	ULOMPI	HINTA	SIEMPI	HINTA
250 Quad Runner 4x4	1990-02	78-08541	19,30	78-08521	19,30				
300 King Quad 4x4	1991-02	78-08521	19,30	78-08521	19,30				
400 Eiger Auto 4x4	2003-07	78-08521	19,30	78-08521	19,30				
400 Eiger Semi-Auto 4x4	2004-07	78-08521	19,30	78-08521	19,30				
400 King Quad 4x4	2008	78-08521	19,30	78-08521	19,30				
450 King Quad AXi 4x4	2008-11	78-08521	19,30	78-08521	19,30	78-08521	19,30	78-08521	19,30
450 King Quad 4x4	2007-10	78-08540-2	19,30	78-03090	19,30	78-08521	19,30	78-08521	19,30
500 King Quad AXi 4x4	2009-10	78-03088	19,30	78-08521	19,30	78-08521	19,30	78-08521	19,30
500 King Quad AXi 4x4	2011-12	78-08540-2	19,30	78-03090	19,30				
500 Quad Master 4x4	2000-01	78-08521	19,30	78-08521	19,30				
500 Quad Runner 4x4	2000-02	78-08521	19,30	78-08521	19,30				
500 Vinson Auto 4x4	2003-07	78-08521	19,30	78-08521	19,30				
500 Vinson Semi-Auto 4x4	2004-07	78-08521	19,30	78-08521	19,30				
550 King Quad 4x4	2012-13	78-08540-2	19,30	78-03090	19,30				
620 QUV 4x4	2005-06	78-08521	19,30	78-08521	19,30				
700 King Quad 4x4	2005-07	78-08521	19,30	78-08521	19,30	78-08521	19,30	78-08521	19,30
700 Twin Peaks 4x4	2004-05	78-08521	19,30	78-08521	19,30				
750 King Quad AXi 4x4	2008-12	78-08540-2	19,30	78-03090	19,30	78-08521	19,30	78-08521	19,30
750 King Quad power steering	2011-	78-03088	19,30	78-03090	19,30				
YAMAHA		ETEEN				TAAKSE			
		ULOMPI	HINTA	SIEMPI	HINTA	ULOMPI	HINTA	SIEMPI	HINTA
250 Timberwolf 4x4	1994-00	78-08541	19,30	78-08593	19,30				
250 Big Bear 4x4	1987-99	78-08521	19,30	78-08521	19,30				
350 Big Bear 4x4	1997-99	78-08541	19,30	78-08593	19,30				
350 Bruin 4x4	2004-06	78-08521	19,30	78-08521	19,30				
350 Grizzly 4x4	2007-11	78-08521	19,30	78-08521	19,30				
350 Grizzly 4x4 (IRS)	2007-11	78-08521	19,30	78-08521	19,30	78-08521	19,30	78-08521	19,30
350 Grizzly 4x4 (IRS)	2012-	78-08541	19,30	78-08525	19,30				
350 Wolverine 4x4	1995-05	78-08521	19,30	78-08521	19,30				
400 Big Bear 4x4 (IRS)	2007-11	78-08521	19,30	78-08521	19,30	78-08521	19,30	78-08521	19,30
400 Big Bear 4x4	2000-06	78-08521	19,30	78-08521	19,30				
400 Grizzly 4x4	2007-08	78-08521	19,30	78-08521	19,30	78-08521	19,30	78-08521	19,30
400 Kodiak Auto 4x4	2005-06	78-08521	19,30	78-08521	19,30	78-08521	19,30	78-08521	19,30
400 Kodiak 4x4	1993-04	78-08521	19,30	78-08521	19,30				
450 Grizzly 4x4	2007-11	78-08521	19,30	78-08521	19,30	78-08521	19,30	78-08521	19,30
450 Grizzly 4x4	2011-12	78-08541	19,30	78-08525	19,30	78-08541	19,30		
450 Kodiak 4x4	2005-06	78-08521	19,30	78-08521	19,30	78-08521	19,30	78-08521	19,30
450 Kodiak 4x4	2003-04	78-08521	19,30	78-08521	19,30				
450 Rhino 4x4	2006-09	78-08521	19,30	78-08521	19,30	78-08521	19,30	78-08521	19,30
450 Wolverine 4x4	2006	78-08521	19,30	78-08521	19,30				
550 Grizzly FI 4x4	2009-12	78-08547	19,30	78-08593	19,30	78-08547	19,30	78-08593	19,30
600 Grizzly 4x4	1998-01	78-08521	19,30	78-08521	19,30	78-08521	19,30	78-08521	19,30
660 Grizzly 4x4	2008-08	78-08521	19,30	78-08521	19,30	78-08521	19,30	78-08521	19,30
660 Rhino 4x4	2004-07	78-08521	19,30	78-08521	19,30	78-08521	19,30	78-08521	19,30
700 Grizzly 4x4	2007-14	78-08521	19,30	78-08521	19,30	78-08521	19,30	78-08521	19,30
700 Grizzly EPS 4x4	2012	78-08547	19,30	78-08593	19,30	78-08547	19,30	78-08593	19,30
700 Rhino FI 4x4	2008-12	78-08542	19,30	78-08540	19,30	78-08542	19,30	78-08540	19,30



Vanteet ja renkaat



Talvituotteet



Vinssit



Laukut ja tuulisuojat



Sähköosat



Jousitus ja voimansiirto



Pakoputket ja suutinsarjat



Ohjauk



Rungon osat ja peitteet



Jarrupalat ja ratat



Moottori



Variaattorin osat



Maatalous-tarvikkeet



Kärryt ja reet



VETOAKSELIN SUOJAKUMISARJAT



ARCTIC CAT		ETEEN ULOMPI				TAAKSE ULOMPI			
			HINTA	SIEMPI	HINTA		HINTA	SIEMPI	HINTA
250 2x4	1999-05	-		-		78-130118	30,00	78-130119	30,00
250 4x4	2001-05	78-130118	30,00	78-130119	30,00	78-130118	30,00	78-130119	30,00
280 4x4	1998	78-130118	30,00	78-130119	30,00	-		-	
300 2x4	2001-03	-		-		78-130118	30,00	78-130119	30,00
300 4x4	2001-05	78-130118	30,00	78-130119	30,00	78-130118	30,00	78-130119	30,00
300 4x4	1998-00	78-130118	30,00	78-130119	30,00	-		-	
371 4x4	1998	78-130118	30,00	78-130119	30,00	-		-	
375 4x4	2002	78-130118	30,00	78-130119	30,00	-		-	
400 2x4	2003-04	-		-		78-130118	30,00	78-130119	30,00
400i 2x4	2002	-		-		78-130118	30,00	78-130119	30,00
400 4x4	1999-04	78-130118	30,00	78-130119	30,00	-		-	
400 4x4 FIS	1998-02	78-130118	30,00	78-130119	30,00	78-130118	30,00	78-130119	30,00
400 ACT/Auto ACT 4x4	2003-04	78-130118	30,00	78-130119	30,00	-		-	
400 TBX 4x4	2002-06	78-130118	30,00	78-130119	30,00	78-130118	30,00	78-130119	30,00
400 TRV 4x4	2006-10	78-130118	30,00	78-130119	30,00	78-130118	30,00	78-130119	30,00
400 VP/Auto VP 4x4	2005-06	78-130118	30,00	78-130119	30,00	-		-	
450 EFI	2010-11	78-130118	30,00	78-130119	30,00	78-130118	30,00	78-130119	30,00
454 4x4	1996-98	78-130118	30,00	78-130119	30,00	-		-	
493 4x4	1998	78-130118	30,00	78-130119	30,00	-		-	
500 4x4 FIS	2002-09	78-130118	30,00	78-130119	30,00	78-130118	30,00	78-130119	30,00
500 TBX 4x4	2003-06	78-130118	30,00	78-130119	30,00	78-130118	30,00	78-130119	30,00
500 TRV 4x4	2004-08	78-130118	30,00	78-130119	30,00	78-130118	30,00	78-130119	30,00
550 H1,EFI	2009-11	78-130118	30,00	78-130119	30,00	78-130118	30,00	78-130119	30,00
550 H1 Prowler 4x4	2009-11	78-130118	30,00	78-130119	30,00	78-130118	30,00	78-130119	30,00
650 H1 4x4	2005-10	78-130118	30,00	78-130119	30,00	78-130118	30,00	78-130119	30,00
650 H1 Prowler 4x4	2006-08	78-130118	30,00	78-130119	30,00	78-130118	30,00	78-130119	30,00
650 TBX 4x4	2007-09	78-130118	30,00	78-130119	30,00	78-130118	30,00	78-130119	30,00
650 TRV 4x4	2007-10	78-130118	30,00	78-130119	30,00	78-130118	30,00	78-130119	30,00
650 V2 4x4	2004-06	78-130118	30,00	78-130119	30,00	78-130118	30,00	78-130119	30,00
700 Diesel 4x4	2008-10	78-130118	30,00	78-130119	30,00	78-130118	30,00	78-130119	30,00
700 EFI Auto 4x4	2006-08	78-130118	30,00	78-130119	30,00	78-130118	30,00	78-130119	30,00
700 H1 EFI 4x4	2008-11	78-130118	30,00	78-130119	30,00	78-130118	30,00	78-130119	30,00
700 H1 Prowler 4x4	2008-11	78-130118	30,00	78-130119	30,00	78-130118	30,00	78-130119	30,00
700 TRV 4x4	2008-11	78-130118	30,00	78-130119	30,00	78-130118	30,00	78-130119	30,00
1000 Prowler XTZ 4x4	2009-11	78-130118	30,00	78-130119	30,00	78-130118	30,00	78-130119	30,00
1000 TRV 4x4	2009-10	78-130118	30,00	78-130119	30,00	78-130118	30,00	78-130119	30,00
CAN-AM		ETEEN ULOMPI				TAAKSE ULOMPI			
			HINTA	SIEMPI	HINTA		HINTA	SIEMPI	HINTA
330 HO Outlander 2x4	2003-05	-		-		78-130118	30,00	78-130119	30,00
330 HO Outlander 4x4	2003-05	78-130118	30,00	78-130119	30,00	78-130118	30,00	78-130119	30,00
400 HO Outlander 4x4	2003-10	78-130118	30,00	78-130119	30,00	78-130118	30,00	78-130119	30,00
400 HO Outlander Max 4x4	2004-10	78-130118	30,00	78-130119	30,00	78-130118	30,00	78-130119	30,00
400 HO Outlander XT	2006-07	78-130118	30,00	78-130119	30,00	78-130118	30,00	78-130119	30,00
400 HO Outlander Max XT	2006-07	78-130118	30,00	78-130119	30,00	78-130118	30,00	78-130119	30,00
500 HO Outlander EFI/XT 4x4	2007-10	78-130118	30,00	78-130119	30,00	78-130118	30,00	78-130119	30,00
500 HO Outlander EFI Max/XT 4x4	2007-10	78-130118	30,00	78-130119	30,00	78-130118	30,00	78-130119	30,00
500 Quest 4x4	2002-04	78-130118	30,00	78-130119	30,00	-		-	
500 Quest XL 4x4	2002	78-130118	30,00	78-130119	30,00	-		-	
500 Renegade 4x4	2008-10	78-130118	30,00	78-130119	30,00	78-130118	30,00	78-130119	30,00
500 Traxter 4x4	1999-05	78-130118	30,00	78-130119	30,00	-		-	
500 Traxter XL 4x4	2002-05	78-130118	30,00	78-130119	30,00	-		-	
500 Traxter Max 4x4	2003-04	78-130118	30,00	78-130119	30,00	-		-	
650 HO Outlander EFI/XT 4x4	2007-11	78-130118	30,00	78-130119	30,00	78-130118	30,00	78-130119	30,00
650 HO Outlander EFI Max/Max XT	2007-11	78-130118	30,00	78-130119	30,00	78-130118	30,00	78-130119	30,00
650 Quest 4x4	2002-04	78-130118	30,00	78-130119	30,00	-		-	
650 Quest Max 4x4	2004	78-130118	30,00	78-130119	30,00	-		-	
650 Traxter Auto 4x4	2005	78-130118	30,00	78-130119	30,00	-		-	
650 Traxter Max Auto 4x4	2005	78-130118	30,00	78-130119	30,00	-		-	
800 HO Outlander EFI	2006-11	78-130118	30,00	78-130119	30,00	78-130118	30,00	78-130119	30,00
800 HO Outlander EFI XT	2006-11	78-130118	30,00	78-130119	30,00	78-130118	30,00	78-130119	30,00
800 HO Outlander EFI Max/Max XT	2006-08	78-130118	30,00	78-130119	30,00	78-130118	30,00	78-130119	30,00
800 Renegade/Renegade X 4x4	2007-11	78-130118	30,00	78-130119	30,00	78-130118	30,00	78-130119	30,00
1000 Commander	2011	78-130118	30,00	78-130119	30,00	78-130118	30,00	78-130119	30,00
HONDA		ETEEN ULOMPI				TAAKSE ULOMPI			
			HINTA	SIEMPI	HINTA		HINTA	SIEMPI	HINTA
300 TRX 4x4	1988-00	78-130118	30,00	78-130119	30,00	-		-	
350 Fourtrax Rancher 4x4	2000-06	78-130118	30,00	78-130119	30,00	-		-	
350 Fourtrax Rancher ES 4x4	2000-06	78-130118	30,00	78-130119	30,00	-		-	
350 TRX 4x4	1986-89	78-130118	30,00	78-130119	30,00	-		-	
400 Fourtrax Foreman 4x4	1995-05	78-130118	30,00	78-130119	30,00	-		-	
400 Fourtrax Rancher 4x4	2004-09	78-130118	30,00	78-130119	30,00	-		-	

ATV

VETOAKSELIN SUOJAKUMISARJAT JATKUU



HONDA		ETEEN ULOMPI			HINTA			SISEMPI			HINTA			TAAKSE ULOMPI			HINTA			SISEMPI			HINTA		
420 Fourtrax Rancher 4x4	2009-11	78-130118	30,00	78-130119	30,00	-	-	-	-	-	-	-	-	-	-	-	-	-	-	-	-	-	-		
450 TRX 4x4	1998-04	78-130118	30,00	78-130119	30,00	-	-	-	-	-	-	-	-	-	-	-	-	-	-	-	-	-	-		
475 Fourtrax Foreman / ES 4x4	2005-11	78-130118	30,00	78-130119	30,00	-	-	-	-	-	-	-	-	-	-	-	-	-	-	-	-	-	-		
500 Fourtrax Foreman Rubicon 4x4	2005-11	78-130118	30,00	78-130119	30,00	-	-	-	-	-	-	-	-	-	-	-	-	-	-	-	-	-	-		
500 Fourtrax Foreman Rubicon GPS-cape	2005-11	78-130118	30,00	78-130119	30,00	-	-	-	-	-	-	-	-	-	-	-	-	-	-	-	-	-	-		
500 TRX Rubicon 4x4	2001-04	78-130118	30,00	78-130119	30,00	-	-	-	-	-	-	-	-	-	-	-	-	-	-	-	-	-	-		
650 TRX Rincon 4x4	2003-05	78-130118	30,00	78-130119	30,00	78-130118	30,00	78-130119	30,00	78-130118	30,00	78-130119	30,00	78-130118	30,00	78-130119	30,00	78-130118	30,00	78-130119	30,00	78-130118	30,00		
650 TRX Rincon GPScape 4x4	2005	78-130118	30,00	78-130119	30,00	78-130118	30,00	78-130119	30,00	78-130118	30,00	78-130119	30,00	78-130118	30,00	78-130119	30,00	78-130118	30,00	78-130119	30,00	78-130118	30,00		
680 Rincon 4x4	2006-11	78-130118	30,00	78-130119	30,00	78-130118	30,00	78-130119	30,00	78-130118	30,00	78-130119	30,00	78-130118	30,00	78-130119	30,00	78-130118	30,00	78-130119	30,00	78-130118	30,00		
680 Rincon GPScape 4x4	2006-11	78-130118	30,00	78-130119	30,00	78-130118	30,00	78-130119	30,00	78-130118	30,00	78-130119	30,00	78-130118	30,00	78-130119	30,00	78-130118	30,00	78-130119	30,00	78-130118	30,00		
KAWASAKI		ETEEN ULOMPI			HINTA			SISEMPI			HINTA			TAAKSE ULOMPI			HINTA			SISEMPI			HINTA		
300 Bayou 4x4	1989-04	78-130118	30,00	78-130119	30,00	-	-	-	-	-	-	-	-	-	-	-	-	-	-	-	-	-	-		
300 Prairie 4x4	1999-02	78-130118	30,00	78-130119	30,00	-	-	-	-	-	-	-	-	-	-	-	-	-	-	-	-	-	-		
360 Prairie 4x4	2003-11	78-130118	30,00	78-130119	30,00	-	-	-	-	-	-	-	-	-	-	-	-	-	-	-	-	-	-		
400 Bayou 4x4	1993-99	78-130118	30,00	78-130119	30,00	-	-	-	-	-	-	-	-	-	-	-	-	-	-	-	-	-	-		
400 Prairie 4x4	1997-02	78-130118	30,00	78-130119	30,00	-	-	-	-	-	-	-	-	-	-	-	-	-	-	-	-	-	-		
610 Mule All 4x4 (400cc)		78-130118	30,00	78-130119	30,00	-	-	-	-	-	-	-	-	-	-	-	-	-	-	-	-	-	-		
650 Brute Force 4x4i	2006-11	78-130118	30,00	78-130119	30,00	78-130118	30,00	78-130119	30,00	78-130118	30,00	78-130119	30,00	78-130118	30,00	78-130119	30,00	78-130118	30,00	78-130119	30,00	78-130118	30,00		
650 Brute Force 4x4	2005-11	78-130118	30,00	78-130119	30,00	-	-	-	-	-	-	-	-	-	-	-	-	-	-	-	-	-	-		
650 Prairie 4x4	2002-03	78-130118	30,00	78-130119	30,00	-	-	-	-	-	-	-	-	-	-	-	-	-	-	-	-	-	-		
700 Prairie 4x4	2004-06	78-130118	30,00	78-130119	30,00	-	-	-	-	-	-	-	-	-	-	-	-	-	-	-	-	-	-		
750 Brute Force 4x4i	2005-11	78-130118	30,00	78-130119	30,00	78-130118	30,00	78-130119	30,00	78-130118	30,00	78-130119	30,00	78-130118	30,00	78-130119	30,00	78-130118	30,00	78-130119	30,00	78-130118	30,00		
750 Teryx 4x4	2008-11	78-130118	30,00	78-130119	30,00	78-130118	30,00	78-130119	30,00	78-130118	30,00	78-130119	30,00	78-130118	30,00	78-130119	30,00	78-130118	30,00	78-130119	30,00	78-130118	30,00		
2010 Mule All 4x4 (540cc)		78-130118	30,00	78-130119	30,00	-	-	-	-	-	-	-	-	-	-	-	-	-	-	-	-	-	-		
2510 Mule All 4x4 (620cc)		78-130118	30,00	78-130119	30,00	-	-	-	-	-	-	-	-	-	-	-	-	-	-	-	-	-	-		
2510 Mule Diesel All 4x4 (950cc)		78-130118	30,00	78-130119	30,00	-	-	-	-	-	-	-	-	-	-	-	-	-	-	-	-	-	-		
3010 Mule All 4x4 (620cc)		78-130118	30,00	78-130119	30,00	-	-	-	-	-	-	-	-	-	-	-	-	-	-	-	-	-	-		
3010 Mule Diesel All 4x4 (950cc)		78-130118	30,00	78-130119	30,00	-	-	-	-	-	-	-	-	-	-	-	-	-	-	-	-	-	-		
4010 Mule 4x4 09-10 (620cc)		78-130118	30,00	78-130119	30,00	-	-	-	-	-	-	-	-	-	-	-	-	-	-	-	-	-	-		
4010 Mule Diesel 4x4 09-10 (650cc)		78-130118	30,00	78-130119	30,00	-	-	-	-	-	-	-	-	-	-	-	-	-	-	-	-	-	-		
KYMCO		ETEEN ULOMPI			HINTA			SISEMPI			HINTA			TAAKSE ULOMPI			HINTA			SISEMPI			HINTA		
500 MXU 4x4	2006-07	78-140042	30,00	78-140047	30,00	-	-	-	-	-	-	-	-	-	-	-	-	-	-	-	-	-	-		
POLARIS		ETEEN ULOMPI			HINTA			SISEMPI			HINTA			TAAKSE ULOMPI			HINTA			SISEMPI			HINTA		
250 Big Boss 4x6	1989-92	78-130118	30,00	-	-	-	-	-	-	-	-	-	-	-	-	-	-	-	-	-	-	-	-		
250 Big Boss 6x6	1991-93	78-130118	30,00	-	-	-	-	-	-	-	-	-	-	-	-	-	-	-	-	-	-	-	-		
250 Trail Boss 4x4	1985-99	78-130118	30,00	-	-	-	-	-	-	-	-	-	-	-	-	-	-	-	-	-	-	-	-		
250 Xplorer 4x4	2000-02	78-130118	30,00	-	-	-	-	-	-	-	-	-	-	-	-	-	-	-	-	-	-	-	-		
300 4x4	1994-95	78-130118	30,00	-	-	-	-	-	-	-	-	-	-	-	-	-	-	-	-	-	-	-	-		
300 Big Boss 6x6	1994	78-130118	30,00	-	-	-	-	-	-	-	-	-	-	-	-	-	-	-	-	-	-	-	-		
300 Hawkeye 2x4	2006-07	-	-	-	-	78-130118	30,00	78-130119	30,00	78-130118	30,00	78-130119	30,00	78-130118	30,00	78-130119	30,00	78-130118	30,00	78-130119	30,00	78-130118	30,00		
300 Hawkeye 4x4	2006-07	78-130118	30,00	78-130119	30,00	78-130118	30,00	78-130119	30,00	78-130118	30,00	78-130119	30,00	78-130118	30,00	78-130119	30,00	78-130118	30,00	78-130119	30,00	78-130118	30,00		
300 Sportsman 4x4	2008-10	78-130118	30,00	78-130119	30,00	78-130118	30,00	78-130119	30,00	78-130118	30,00	78-130119	30,00	78-130118	30,00	78-130119	30,00	78-130118	30,00	78-130119	30,00	78-130118	30,00		
300 Xplorer 4x4	1996-99	78-130118	30,00	-	-	-	-	-	-	-	-	-	-	-	-	-	-	-	-	-	-	-	-		
325 Magnum 4x4	2000-02	78-130118	30,00	-	-	-	-	-	-	-	-	-	-	-	-	-	-	-	-	-	-	-	-		
325 Xpedition 4x4	2000-02	78-130118	30,00	-	-	-	-	-	-	-	-	-	-	-	-	-	-	-	-	-	-	-	-		
330 ATP 4x4	2004-05	78-130118	30,00	-	-	-	-	-	-	-	-	-	-	-	-	-	-	-	-	-	-	-	-		
330 Magnum 4x4	2003-06	78-130118	30,00	-	-	-	-	-	-	-	-	-	-	-	-	-	-	-	-	-	-	-	-		
335 Sportsman 4x4	1999-00	78-130118	30,00	-	-	78-130118	30,00	78-130119	30,00	78-130118	30,00	78-130119	30,00	78-130118	30,00	78-130119	30,00	78-130118	30,00	78-130119	30,00	78-130118	30,00		
350 Big Boss 6x6	1993	78-130118	30,00	-	-	-	-	-	-	-	-	-	-	-	-	-	-	-	-	-	-	-	-		
350 Trail Boss 4x4	1991-93	78-130118	30,00	-	-	-	-	-	-	-	-	-	-	-	-	-	-	-	-	-	-	-	-		
400 4x4	1994	78-130118	30,00	-	-	-	-	-	-	-	-	-	-	-	-	-	-	-	-	-	-	-	-		
400 Big Boss 6x6	1994-97	78-130118	30,00	-	-	-	-	-	-	-	-	-	-	-	-	-	-	-	-	-	-	-	-		
400 Ranger 4x4	2010	78-130118	30,00	78-130119	30,00	78-130118	30,00	78-130119	30,00	78-130118	30,00	78-130119	30,00	78-130118	30,00	78-130119	30,00	78-130118	30,00	78-130119	30,00	78-130118	30,00		
400 Scrambler 4x4	1995-00	78-130118	30,00	-	-	-	-	-	-	-	-	-	-	-	-	-	-	-	-	-	-	-	-		
400 Sportsman 4x4	2005-11	78-130118	30,00	78-130119	30,00	78-130118	30,00	78-130119	30,00	78-130118	30,00	78-130119	30,00	78-130118	30,00	78-130119	30,00	78-130118	30,00	78-130119	30,00	78-130118	30,00		
400 Sportsman 4x4	2001-04	78-130118	30,00	-	-	78-130118	30,00	78-130119	30,00	78-130118	30,00	78-130119	30,00	78-130118	30,00	78-130119	30,00	78-130118							



VETOAKSELIN SUOJAKUMISARJAT JATKUU

		ETEEN				TAAKSE			
		ULOMPI	HINTA	SIEMPI	HINTA	ULOMPI	HINTA	SIEMPI	HINTA
POLARIS									
500 Ranger EFI 4x4	2006-11	78-130118	30,00	78-130119	30,00	78-130118	30,00	78-130119	30,00
500 Scrambler 4x4	1997-10	78-130118	30,00	-	-	-	-	-	-
500 Sportsman 4x4	1998-02	78-130118	30,00	-	-	78-130118	30,00	78-130119	30,00
500 Sportsman 4x4	1996-97	78-130118	30,00	-	-	-	-	-	-
500 Sportsman 6x6	2000-07	78-130118	30,00	-	-	-	-	-	-
500 Sportsman EFI Touring 4x4	2008-11	78-130118	30,00	78-130119	30,00	78-130118	30,00	78-130119	30,00
500 Sportsman HO Touring 4x4	2010	78-130118	30,00	78-130119	30,00	78-130118	30,00	78-130119	30,00
500 Sportsman EFI 4x4	2006-09	78-130118	30,00	78-130119	30,00	78-130118	30,00	78-130119	30,00
500 Sportsman HO 4x4	2005-11	78-130118	30,00	78-130119	30,00	78-130118	30,00	78-130119	30,00
500 Sportsman HO 4x4	2001-04	78-130118	30,00	-	-	78-130118	30,00	78-130119	30,00
500 Sportsman X2 4x4	2006	78-130118	30,00	78-130119	30,00	78-130118	30,00	78-130119	30,00
500 Sportsman X2 EFI 4x4	2007-09	78-130118	30,00	78-130119	30,00	78-130118	30,00	78-130119	30,00
500 Xplorer 4x4	1997	78-130118	30,00	-	-	78-130118	30,00	78-130119	30,00
550 Sportsman XP 4x4	2009-11	78-130118	30,00	78-130119	30,00	78-130118	30,00	78-130119	30,00
550 Sportsman X2 4x4	2010-11	78-130118	30,00	78-130119	30,00	78-130118	30,00	78-130119	30,00
600 Sportsman 4x4	2005	78-130118	30,00	78-130119	30,00	78-130118	30,00	78-130119	30,00
600 Sportsman 4x4	2003-04	78-130118	30,00	-	-	78-130118	30,00	78-130119	30,00
700 MV7 4x4	2005	78-130118	30,00	78-130119	30,00	78-130118	30,00	78-130119	30,00
700 Ranger Ranger Crew 4x4	2008-09	78-130118	30,00	78-130119	30,00	78-130118	30,00	78-130119	30,00
700 Ranger EFI 6x6	2006-07	78-130118	30,00	78-130119	30,00	-	-	-	-
700 Ranger XP 4x4	2005-09	78-130118	30,00	78-130119	30,00	78-130118	30,00	78-130119	30,00
700 Sportsman 4x4	2005	78-130118	30,00	78-130119	30,00	78-130118	30,00	78-130119	30,00
700 Sportsman 4x4	2002-04	78-130118	30,00	-	-	78-130118	30,00	78-130119	30,00
700 Sportsman EFI 4x4	2005-07	78-130118	30,00	78-130119	30,00	78-130118	30,00	78-130119	30,00
700 Sportsman EFI 4x4	2004	78-130118	30,00	-	-	78-130118	30,00	78-130119	30,00
700 Sportsman EFI X2 4x4	2008-09	78-130118	30,00	78-130119	30,00	78-130118	30,00	78-130119	30,00
700 Sportsman EFI 4x4	2004	78-130118	30,00	-	-	78-130118	30,00	78-130119	30,00
800 Big Boss 6x6	2010-11	78-130118	30,00	78-130119	30,00	-	-	-	-
800 Ranger Crew 4x4	2010-11	78-130118	30,00	78-130119	30,00	78-130118	30,00	78-130119	30,00
800 Ranger XP 4x4	2010-11	78-130118	30,00	78-130119	30,00	78-130118	30,00	78-130119	30,00
800 RZR 4x4	2008-11	78-130118	30,00	78-130119	30,00	78-130118	30,00	78-130119	30,00
800 RZR S 4x4	2009-11	78-130118	30,00	78-130119	30,00	78-130118	30,00	78-130119	30,00
800 Sportsman EFI 4x4	2005-11	78-130118	30,00	78-130119	30,00	78-130118	30,00	78-130119	30,00
800 Sportsman EFI X2 4x4	2007	78-130118	30,00	78-130119	30,00	78-130118	30,00	78-130119	30,00
850 Sportsman XP 4x4	2009-11	78-130118	30,00	78-130119	30,00	78-130118	30,00	78-130119	30,00
SUZUKI									
250 Quad Runner 4x4	1990-02	78-130118	30,00	78-130119	30,00	-	-	-	-
300 King Quad 4x4	1991-02	78-130118	30,00	78-130119	30,00	-	-	-	-
400 Eiger Auto 4x4	2003-07	78-130118	30,00	78-130119	30,00	-	-	-	-
400 Eiger Semi-Auto 4x4	2004-07	78-130118	30,00	78-130119	30,00	-	-	-	-
400 King Quad 4x4	2008	78-130118	30,00	78-130119	30,00	-	-	-	-
450 King Quad AXi 4x4	2008-11	78-130118	30,00	78-130119	30,00	78-130118	30,00	78-130119	30,00
450 King Quad 4x4	2007	78-130118	30,00	78-130119	30,00	78-130118	30,00	78-130119	30,00
500 King Quad AXi 4x4	2009-11	78-130118	30,00	78-130119	30,00	78-130118	30,00	78-130119	30,00
500 Quad Master 4x4	2000-01	78-130118	30,00	78-130119	30,00	-	-	-	-
500 Quad Runner 4x4	2000-02	78-130118	30,00	78-130119	30,00	-	-	-	-
500 Vinson Auto 4x4	2003-07	78-130118	30,00	78-130119	30,00	-	-	-	-
500 Vinson Semi-Auto 4x4	2004-07	78-130118	30,00	78-130119	30,00	-	-	-	-
620 QUV 4x4	2005-06	78-130118	30,00	78-130119	30,00	-	-	-	-
700 King Quad 4x4	2005-07	78-130118	30,00	78-130119	30,00	78-130118	30,00	78-130119	30,00
700 Twin Peaks 4x4	2004-05	78-130118	30,00	78-130119	30,00	-	-	-	-
750 King Quad AXi 4x4	2008-11	78-130118	30,00	78-130119	30,00	78-130118	30,00	78-130119	30,00
YAMAHA									
250 Timberwolf 4x4	1994-00	78-130118	30,00	78-130119	30,00	-	-	-	-
250 Big Bear 4x4	1987-99	78-130118	30,00	78-130119	30,00	-	-	-	-
350 Bruin 4x4	2004-06	78-130118	30,00	78-130119	30,00	-	-	-	-
350 Grizzly 4x4	2007-11	78-130118	30,00	78-130119	30,00	-	-	-	-
350 Grizzly 4x4 (IRS)	2007-11	78-130118	30,00	78-130119	30,00	78-130118	30,00	78-130119	30,00
350 Wolverine 4x4	1995-05	78-130118	30,00	78-130119	30,00	-	-	-	-
400 Big Bear 4x4 (IRS)	2007-11	78-130118	30,00	78-130119	30,00	78-130118	30,00	78-130119	30,00
400 Big Bear 4x4	2000-06	78-130118	30,00	78-130119	30,00	-	-	-	-
400 Grizzly 4x4	2007-08	78-130118	30,00	78-130119	30,00	78-130118	30,00	78-130119	30,00
400 Kodiak Auto 4x4	2005-06	78-130118	30,00	78-130119	30,00	78-130118	30,00	78-130119	30,00
400 Kodiak 4x4	1993-04	78-130118	30,00	78-130119	30,00	-	-	-	-
450 Grizzly 4x4	2007-11	78-130118	30,00	78-130119	30,00	78-130118	30,00	78-130119	30,00
450 Kodiak 4x4	2005-06	78-130118	30,00	78-130119	30,00	78-130118	30,00	78-130119	30,00
450 Kodiak 4x4	2003-04	78-130118	30,00	78-130119	30,00	-	-	-	-
450 Rhino 4x4	2006-09	78-130118	30,00	78-130119	30,00	78-130118	30,00	78-130119	30,00
450 Wolverine 4x4	2006	78-130118	30,00	78-130119	30,00	-	-	-	-
550 Grizzly FI 4x4	2009-11	78-130118	30,00	78-130119	30,00	78-130118	30,00	78-130119	30,00
600 Grizzly 4x4	1998-01	78-130118	30,00	78-130119	30,00	78-130118	30,00	78-130119	30,00
660 Grizzly 4x4	2008-08	78-130118	30,00	78-130119	30,00	78-130118	30,00	78-130119	30,00
660 Rhino 4x4	2004-07	78-130118	30,00	78-130119	30,00	78-130118	30,00	78-130119	30,00
700 Grizzly 4x4	2007-11	78-130118	30,00	78-130119	30,00	78-130118	30,00	78-130119	30,00
700 Rhino FI 4x4	2008-11	78-130118	30,00	78-130119	30,00	78-130118	30,00	78-130119	30,00

ATV

RISTINIVELET

Heavy-Duty, erikoisvahvistettu.

Jos mönkijäsi kardaaniakselissa esiintyy voimakasta värinää tai kuulet loksahdavia ääniä liikkeelle lähdeittäessä, voivat ne johtua kuluneista ristiniveleistä.

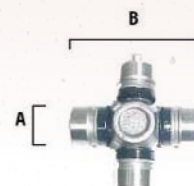

SOPIVUUSTAULUKKO

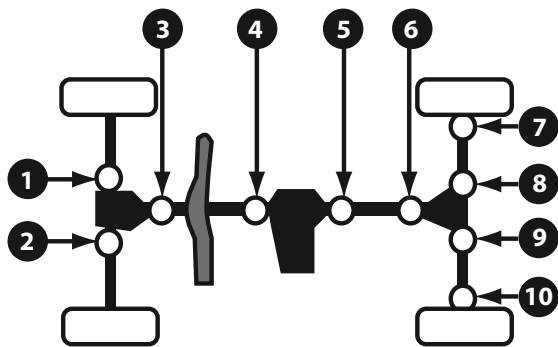

ARCTIC CAT	Vuosim.	Kuva nro.	Bronco	Hinta	Epi	Hinta
250 2x4	2006-08	5			78-100602	34,00
250 4x4	2001-05	4	78-08514	19,90	78-100515	25,80
300 4x4	1998-05	4	78-08514	19,90	78-100515	25,80
375 4x4	2002	4	78-08515	19,90	78-100510	23,80
400 4x4 w/AT	2003-04	4	78-08515	19,90	78-100510	23,80
400 4x4 w/MT	2003-04	4	78-08515	19,90	78-100510	23,80
400 4x4 w/MT	2002	4	78-08514	19,90	78-100515	25,80
400 4x4 w/MT	2001	3, 4	78-08514	19,90	78-100515	25,80
400 4x4	1998-00	4	78-08514	19,90	78-100515	25,80
400 FIS 4x4 w/AT	2003-08	4	78-08515	19,90	78-100510	23,80
400 FIS 4x4 w/MT	2003-08	4	78-08515	19,90	78-100510	23,80
400 FIS 4x4 w/MT	2002	4	78-08514	19,90	78-100515	25,80
400 TBX 4x4	2004-06	4	78-08515	19,90	78-100510	23,80
400 TRV 4x4	2007	4	78-08515	19,90	78-100510	23,80
400 TRV FIS 4x4	2009-13	4	78-08515	19,90	78-100510	23,80
400 VP 4x4	2005-06	3, 4	78-08515	19,90	78-100510	23,80
450i EFI 4x4	2012	4	78-08515	19,90	78-100510	23,80
450 H1 4x4	2010-11	4	78-08515	19,90	78-100510	23,80
450i TRV EFI 4x4	2012	4	78-08515	19,90	78-100510	23,80
450i TRV GT EFI 4x4	2012	4	78-08515	19,90	78-100510	23,80
454 4x4	1996-98	4	78-08514	19,90	78-100515	25,80
500 4x4 w/AT	2000-02	3, 4	78-08514	19,90	78-100515	25,80
500 4x4 w/MT	2000-01	3, 4	78-08514	19,90	78-100515	25,80
500 4x4	1998-99	4	78-08514	19,90	78-100515	25,80
500 EFI 4x4	2013	3	78-08515	19,90	78-100510	23,80
500 FIS 4x4 w/AT	2003-09	3	78-08515	19,90	78-100510	23,80
500 FIS 4x4 w/AT	2002	3	78-08514	19,90	78-100515	25,80
500 FIS 4x4 w/MT	2003-09	3	78-08515	19,90	78-100510	23,80
500 FIS 4x4 w/MT	2002	3	78-08514	19,90	78-100515	25,80
500 FIS TBX 4x4	2003-06	3	78-08514	19,90	78-100515	25,80
500 FIS TBX 4x4	2002	3, 6	78-08514	19,90	78-100515	25,80
500 FIS TRV 4x4	2008	3	78-08515	19,90	78-100510	23,80
500 FIS TRV 4x4	2003-06	3	78-08515	19,90	78-100510	23,80
500 TRV 4x4	2013	3	78-08515	19,90	78-100510	23,80
500 XT EFI 4x4	2013	3	78-08515	19,90	78-100510	23,80
550 EFI 4x4	2013	3	78-08515	19,90	78-100510	23,80
550i EFI 4x4	2012	3	78-08515	19,90	78-100510	23,80
550 GT EFI 4x4	2012	3	78-08515	19,90	78-100510	23,80
550 H1 FIS 4x4	2009-11	3	78-08515	19,90	78-100510	23,80
550 TRV 4x4	2013	3	78-08515	19,90	78-100510	23,80
550 TRV 4x4 w/AT	2009-11	3	78-08515	19,90	78-100510	23,80
550i TRV GT EFI 4x4	2012	3	78-08515	19,90	78-100510	23,80
550 TRV XT 4x4	2013	4	78-08515	19,90	78-100510	23,80
550 XT EFI 4x4	2013	4	78-08515	19,90	78-100510	23,80
650 H1 4x4	2005-11	4	78-08515	19,90	78-100510	23,80

MITTATAULUKKO

Bronco	EPI	A(MM)	B(MM)
78-08500	78-100290	20	58,7
78-08501	78-100507	25,4	82
78-08502	78-100995	27	65,5
78-08503	78-100338	23,9	59,5
78-08507	78-100811	22	55,6
78-08509	78-100603	25	66
78-08513	78-100220	22	53,2
78-08514	78-100515	25	63,3
78-08515	78-100510	20	56,4
78-08516	78-100395	20	37
78-08518	78-100275	25	65
78-08532	78-100996	22	55,35
78-08533	78-100997	25	64,7
78-08534	78-100230	36	58
78-08535	78-100210	20	50,6
78-08536	78-100223	32,9	56,6
78-08537	78-100227	20	51
78-08538	78-100280	31	51

650 H1 Mud Pro 4x4	2010-11	4	78-08515	19,90	78-100510	23,80
650 H1 Prowler XT 4x4	2007-09	5, 6			78-100603	34,00
650 H1 Prowler XT 4x4	2006	3, 4	78-08515	19,90	78-100510	23,80
		5, 6	78-08509		78-100603	34,00
650 V2 4x4	2004-06	3, 4	78-08515	19,90	78-100510	23,80
		5, 6	78-08509		78-100603	34,00
700 Diesel 4x4	2008-11	4	78-08515	19,90	78-100510	23,80
700i Diesel EFI 4x4	2012-13	4	78-08515	19,90	78-100510	23,80
700 EFI 4x4	2009-12	3	78-08515	19,90	78-100510	23,80
700 EFI Auto 4x4	2007-08	3, 4	78-08515	19,90	78-100510	23,80
700 GT EFI 4x4	2012	4	78-08515	19,90	78-100510	23,80
700 H1 EFI 4x4	2008-11	4	78-08515	19,90	78-100510	23,80
700i Mud Pro 4x4	2012-13	3	78-08515	19,90	78-100510	23,80
700 H1 Mud Pro 4x4	2009-11	4	78-08515	19,90	78-100510	23,80
700 H1 TRV 4x4	2009-11	3	78-08515	19,90	78-100510	23,80
700 H1 TRV 4x4	2008	3, 4	78-08515	19,90	78-100510	23,80
700 LTD EFI 4x4	2013	3	78-08515	19,90	78-100510	23,80
700i TRV Crusier EFI 4x4	2012	3	78-08515	19,90	78-100510	23,80
700i TRV GT EFI 4x4	2012	3	78-08515	19,90	78-100510	23,80
700 XT 4x4	2013	3, 4, 5, 6	78-08514	19,90	78-100515	25,80
1000 Cruiser 4x4	2012	3, 4, 5, 6	78-08514	19,90	78-100515	25,80
1000i GT 4x4	2012	3, 4, 5, 6	78-08514	19,90	78-100515	25,80
1000i Mud Pro LTD 4x4	2012-13	3, 4, 5, 6	78-08514	19,90	78-100515	25,80
1000 H2 Mud Pro 4x4	2010-11	3, 4, 5, 6	78-08514	19,90	78-100515	25,80
1000 TRV GT 4x4	2012	3, 4, 5, 6	78-08514	19,90	78-100515	25,80
1000 TRV LTD 4x4	2013	3, 4, 5, 6	78-08514	19,90	78-100515	25,80
1000 Prowler XTZ 4x4	2010-13	3, 4	78-08514	19,90	78-100515	25,80
1000 H2 Prowler XTZ 4x4	2009	3, 4, 5, 6	78-08514	19,90	78-100515	25,80
1000 H2 Thunder Cat 4x4	2009-11	3, 4, 5, 6	78-08514	19,90	78-100515	25,80
1000 H2 Thunder Cat 4x4	2008	3, 4	78-08515	19,90	78-100510	23,80
		5, 6	78-08514	19,90	78-100515	25,80
1000 XT 4x4	2013	3, 4, 5, 6	78-08514	19,90	78-100515	25,80





Vanteet ja renkaat



Talvituotteet



Vinssit



Laukut ja tuulisuojat



Sähköosat



Jousitus ja voimansiirto



Pakoputket ja suutinsarjat



Ohjaus



Rungon osat ja peitteet



Jarrupalat ja rattaat



Moottori



Variaattorin osat



Maatalous-tarvikkeet



Kärryt ja reet



Kärryt ja reet



Kärryt ja reet



Kärryt ja reet



Kärryt ja reet

RISTINIVELET JATKUU

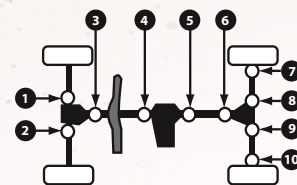

CAN-AM	Vuosim.	Kuva nro.	Bronco	Hinta	Epi	Hinta
330 Outlander 2x4	2004-05	5, 6	78-08532	19,90	78-100996	23,80
330 Outlander 4x4	2004-05	5, 6	78-08532	19,90	78-100996	23,80
400 Outlander 2x4	2003-05	5, 6	78-08532	19,90	78-100996	23,80
400 Outlander 4x4	2006-13	5, 6	78-08532	19,90	78-100996	23,80
400 Outlander 4x4	2003-05	5, 6	78-08532	19,90	78-100996	23,80
500 Outlander 4x4	2013	5, 6	78-08533	19,90	78-100997	28,90
500 Outlander 4x4	2007-12	4	78-08532	19,90	78-100996	23,80
		5, 6	78-08533	19,90	78-100997	28,90
500 Quest 4x4	2004	5	78-08532	19,90	78-100996	23,80
500 Quest 4x4	2002-03	3, 4, 5	78-08532	19,90	78-100996	23,80
		5, 6	78-08533	19,90	78-100997	28,90
500 Renegade 4x4	2013	4	78-08532	19,90	78-100996	23,80
500 Renegade 4x4	2008-12	5, 6	78-08533	19,90	78-100997	28,90
		5, 6	78-08533	19,90	78-100997	28,90
650 Outlander 4x4	2013	5, 6	78-08533	19,90	78-100997	28,90
650 Outlander 4x4	2006-12	4	78-08532	19,90	78-100996	23,80
		5, 6	78-08533	19,90	78-100997	28,90
650 Quest 4x4	2004	5	78-08533	19,90	78-100997	28,90
650 Quest 4x4	2002-03	3, 4	78-08532	19,90	78-100996	23,80
		5	78-08533	19,90	78-100997	28,90
800 Outlander 4x4	2012-13	5, 6	78-08533	19,90	78-100997	28,90
800 Outlander 4x4	2006-11	4	78-08532	19,90	78-100996	23,80
		5, 6	78-08533	19,90	78-100997	28,90
800 Renegade 4x4	2012-13	5, 6	78-08533	19,90	78-100997	28,90
800 Renegade 4x4	2007-11	4	78-08532	19,90	78-100996	23,80
		5, 6	78-08533	19,90	78-100997	28,90
800 Commander 4x4	2013	5, 6	78-08533	19,90	78-100997	28,90
800 Commander 4x4	2011-12	3, 4	78-08532	19,90	78-100996	23,80
		5, 6	78-08533	19,90	78-100997	28,90
		5, 6	78-08533	19,90	78-100997	28,90
1000 Commander 4x4	2013	5, 6	78-08533	19,90	78-100997	28,90
1000 Commander 4x4	2011-12	3, 4	78-08532	19,90	78-100996	23,80
		5, 6	78-08533	19,90	78-100997	28,90
1000 Outlander 4x4	2012-13	5, 6	78-08533	19,90	78-100997	28,90
1000 Renegade 4x4	2012-13	5, 6	78-08533	19,90	78-100997	28,90
Traxter 4x4	1999-05	3, 4, 5	78-08532	19,90	78-100996	23,80
HONDA	Vuosim.	Kuva nro.	Bronco	Hinta	Epi	Hinta
TRX 250 Recon	1997-13	5			78-100992	46,50
TRX 250 EX Sportrax	2001-12	5			78-100992	46,50
TRX 300 Fourtrax	1988-00	5			78-100992	46,50
TRX 300 FW Fourtrax 4x4	1988-00	5			78-100992	46,50
TRX 350 FE/FM/TE/TM	2000-06	5			78-100992	46,50
TRX 400 FGA Fourtrax Rancher 4x4	2004-07	5			78-100992	46,50
TRX 400 FW Fourtrax Rancher 4x4	1995-03	5			78-100992	46,50
TRX 420 FA/FPA	2009-13	5			78-100993	57,50
TRX 420 FE/FM	2007-13	5			78-100993	57,50
TRX 420 FPE/FPM	2011-13	5			78-100993	57,50
TRX 420 TE/TM	2007-10	5			78-100993	57,50
TRX 450 ES	1998-01	5			78-100992	46,50
TRX 450 FE/FM	2002-04	5			78-100992	46,50
TRX 450 S	1998-01	5			78-100992	46,50
TRX 500 FA	2001-13	5			78-100992	46,50
TRX 500 FE/FM	2005-11	5			78-100992	46,50
TRX 500 FGA	2004-09	5			78-100992	46,50
TRX 500 FPA	2009-13	5			78-100992	46,50
TRX 500 FPE/FPM	2008-11	5			78-100992	46,50
TRX 500 TM	2005-06	5			78-100992	46,50
TRX 650 Rincon	2003-05	5			78-100994	62,00
TRX 680 Rincon	2006-13	5			78-100994	62,00

KAWASAKI	Vuosim.	Kuva nro.	Bronco	Hinta	Epi	Hinta
300 Bayou 4x4	1989-04	3, 4	78-08531	19,90	78-100200	23,80
300 Prairie 2x4	1999-02	6	78-08513	19,90	78-100220	23,80
300 Prairie 4x4	1999-02	3, 4	78-08535	19,90	78-100210	23,80
		5	78-08513	19,90	78-100220	23,80
360 Prairie 2x4	2003-09	6	78-08534	19,90	78-100230	23,80
360 Prairie 4x4	2003-13	5	78-08534	19,90	78-100230	23,80
400 Bayou 4x4	1993-99	3, 4	78-08535	19,90	78-100210	23,80
400 Prairie 2x4	1998-02	6	78-08513	19,90	78-100220	23,80
400 Prairie 4x4	1998-02	3, 4	78-08535	19,90	78-100210	23,80
		5	78-08513	19,90	78-100220	23,80
400 Prairie 4x4	1997	3, 4	78-08535	19,90	78-100210	23,80
		5	78-08513	19,90	78-100220	23,80
610 Mule 4x4 (400cc)	2005-13	3, 4, 5, 6	78-08513	19,90	78-100220	23,80
650 Brute Force 4x4	2005-12	5	78-08534	19,90	78-100230	23,80
650i Brute Force 4x4	2006-13	5, 6	78-08534	19,90	78-100230	23,80
650 Prairie 4x4	2002-03	5	78-08534	19,90	78-100230	23,80
KFX 700 2x4	2004-09	6	78-08534	19,90	78-100230	23,80
700 Prairie 4x4	2004-06	5	78-08534	19,90	78-100230	23,80
750i Brute Force 4x4	2005-13	5, 6	78-08534	19,90	78-100230	23,80
750i Brute Force EPS 4x4	2012-13	5, 6	78-08534	19,90	78-100230	23,80
750 Teryx 4x4	2008-13	3, 4	78-08513	19,90	78-100220	23,80
		5, 6	78-08539	20,90	78-100240	24,80
1000 Mule 2x4 (450cc)	1988	7, 10	78-08513	19,90	78-100220	23,80
2500 Mule 2x4 (620cc)	1994-00	7, 8, 9, 10	78-08539	20,90	78-100240	24,80
2510 Mule 4x4 (620cc)	2000-02	4, 5, 6	78-08513	19,90	78-100220	23,80
		7, 8, 9, 10	78-08539	20,90	78-100240	24,80
2510 Mule 4x4 (620cc)	1993-99	1, 2	78-08539	20,90	78-100240	24,80
		4, 5, 6	78-08531	19,90	78-100200	23,80
		7, 8, 9, 10	78-08539	20,90	78-100240	24,80
2510 Mule Diesel 4x4 (950cc)	2000-02	4, 5, 6	78-08513	19,90	78-100220	23,80
		7, 8, 9, 10	78-08539	20,90	78-100240	24,80
2520 Mule 2x4 (620cc)	1993-00	1, 2, 3, 4	78-08539	20,90	78-100240	24,80
3000 Mule 2x4 (620cc)	2001-08	7, 8, 9, 10	78-08539	20,90	78-100240	24,80
3010 Mule 4x4 (620cc)	2001-08	4, 5, 6	78-08513	19,90	78-100220	23,80
		7, 8, 9, 10	78-08539	20,90	78-100240	24,80
3010 Mule Diesel 4x4 (950cc)	2001-08	4, 5, 6	78-08513	19,90	78-100220	23,80
		7, 8, 9, 10	78-08539	20,90	78-100240	24,80
3020 Mule 2x4 (620cc)	2001-03	7, 8, 9, 10	78-08539	20,90	78-100240	24,80
4000 Mule 2x4 (620cc)	2009-13	7, 8, 9, 10	78-08539	20,90	78-100240	24,80
4010 Mule 4x4 (620cc)	2009-12	4, 5, 6	78-08513	19,90	78-100220	23,80
		7, 8, 9, 10	78-08539	20,90	78-100240	24,80
4010 Mule Diesel 4x4 (950cc)	2009-13	4, 5, 6	78-08513	19,90	78-100220	23,80
		7, 8, 9, 10	78-08539	20,90	78-100240	24,80
POLARIS	Vuosim.	Kuva nro.	Bronco	Hinta	Epi	Hinta
250 4x4	1990/93	1, 2	78-08503	19,90	78-100338	23,80
250 6x6	1993	1, 2	78-08503	19,90	78-100338	23,80
250 Big Boss 6x6	1991-92	1, 2	78-08503	19,90	78-100338	23,80
250 Trail Boss 4x4	1987-92	1, 2	78-08503	19,90	78-100338	23,80



RISTINIVELET JATKUU

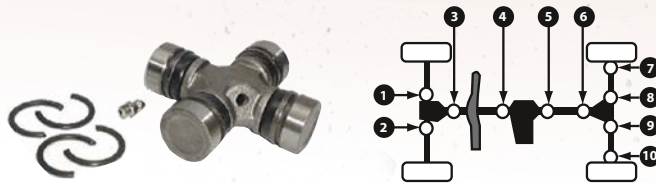

POLARIS	Vuosim.	Kuva nro.	Bronco	Hinta	Epi	Hinta
250 Xplorer 4x4	2000-02	1, 2, 3, 4	78-08503	19,90	78-100338	23,80
300 4x4	1994/96	1, 2	78-08503	19,90	78-100338	23,80
300 4x4	1995	1, 2	78-08507	19,90	78-100811	23,80
300 6x6	1994	1, 2	78-08503	19,90	78-100338	23,80
300 Sportsman 4x4	2008-10	3, 4	78-08503	19,90	78-100338	23,80
300 Xplorer 4x4	1996-99	1, 2	78-08507	19,90	78-100811	23,80
325 Magnum 2x4	2000-02	5	78-08503	19,90	78-100338	23,80
325 Magnum 4x4 exc. HDS (Visco-Loc)	2001-02	1, 2	78-08507	19,90	78-100811	23,80
		3, 4, 5	78-08503	19,90	78-100338	23,80
325 Magnum 4x4 HDS (Visco-Loc)	2001-02	5	78-08503	19,90	78-100338	23,80
325 Magnum 4x4	2000	1, 2	78-08507	19,90	78-100811	23,80
		3, 4, 5	78-08503	19,90	78-100338	23,80
325 Xpedition 4x4	2000-02	1, 2	78-08507	19,90	78-100811	23,80
		3, 4, 5	78-08503	19,90	78-100338	23,80
330 ATP 4x4	2005	3, 4	78-08503	19,90	78-100338	23,80
		5	78-08507	19,90	78-100811	23,80
330 ATP 4x4	2004	1, 2, 3, 4	78-08503	19,90	78-100338	23,80
		5	78-08507	19,90	78-100811	23,80
330 Magnum 2x4	2003-05	5	78-08507	19,90	78-100811	23,80
330 Magnum 4x4	2005-06	3, 4	78-08503	19,90	78-100338	23,80
		5	78-08507	19,90	78-100811	23,80
330 Magnum 4x4 exc. HDS (Visco-Loc)	2003-04	1, 2, 3, 4	78-08503	19,90	78-100338	23,80
		5	78-08507	19,90	78-100811	23,80
330 Magnum 4x4 HDS (Visco-Loc)	2003-04	3, 4	78-08503	19,90	78-100338	23,80
		5	78-08507	19,90	78-100811	23,80
335 Sportsman 4x4	1999-00	1, 2	78-08507	19,90	78-100811	23,80
		3, 4	78-08503	19,90	78-100338	23,80
		7, 10	78-08502	19,90	78-100995	25,50
		8, 9	78-08501	19,90	78-100507	23,80
335 Worker 4x4	1999	1, 2	78-08507	19,90	78-100811	23,80
		3, 4	78-08503	19,90	78-100338	23,80
		7, 10	78-08502	19,90	78-100995	25,50
		8, 9	78-08501	19,90	78-100507	23,80
350L 4x4	1990/93	1, 2	78-08503	19,90	78-100338	23,80
350L 6x6	1993	1, 2	78-08503	19,90	78-100338	23,80
350L Trail Boss 4x4	1990-92	1, 2	78-08503	19,90	78-100338	23,80
400 4x4	1994	1, 2	78-08503	19,90	78-100338	23,80
400 6x6 w/inside lock rings	1995	1, 2	78-08503	19,90	78-100338	23,80
400 6x6 w/outside lock rings	1995	1, 2	78-08507	19,90	78-100811	23,80
400 6x6	1994	1, 2	78-08503	19,90	78-100338	23,80
400 Ranger 4x4	2010-12	3, 4	78-08503	19,90	78-100338	23,80
400 Ranger Mid-Size 4x4	2013	3, 4	78-08503	19,90	78-100338	23,80
400 Scrambler 4x4 front axle w/inside lock rings	1998-02	3, 4	78-08503	19,90	78-100338	23,80
		1, 2	78-08503	19,90	78-100338	23,80
400 Scrambler 4x4 front axle w/outside lock rings		1, 2	78-08507	19,90	78-100811	23,80
400 Scrambler 4x4 w/inside lock rings	1995-97	1, 2	78-08503	19,90	78-100338	23,80
400 Scrambler 4x4 w/outside lock rings	1995-97	1, 2	78-08507	19,90	78-100811	23,80
400 Sportsman 4x4	2005	3, 4	78-08503	19,90	78-100338	23,80
400 Sportsman 4x4	2002-04	1, 2, 3, 4	78-08503	19,90	78-100338	23,80
400 Sportsman 4x4	2001	3, 4	78-08503	19,90	78-100338	23,80
400 Sportsman 4x4	1997	1, 2	78-08507	19,90	78-100811	23,80
400 Sportsman 4x4 w/inside lock rings	1995-96	1, 2	78-08503	19,90	78-100338	23,80

400 Sportsman 4x4 w/outside lock rings	1995-96	1, 2	78-08507	19,90	78-100811	23,80
400 Sportsman 4x4	1993-94	1, 2	78-08503	19,90	78-100338	23,80
400 Sportsman HO 4x4	2008-13	3, 4	78-08503	19,90	78-100338	23,80
400 Xplorer 4x4	1999-02	1, 2, 3, 4	78-08503	19,90	78-100338	23,80
400 Xplorer 4x4	1997-98	1, 2	78-08507	19,90	78-100811	23,80
400 Xplorer 4x4 w/inside lock rings	1995-96	1, 2	78-08503	19,90	78-100338	23,80
400 Xplorer 4x4 w/outside lock rings	1995-96	1, 2	78-08507	19,90	78-100811	23,80
400L Big Boss 6x6	1997	1, 2	78-08507	19,90	78-100811	23,80
425 Magnum 4x4	1997-98	1, 2	78-08507	19,90	78-100811	23,80
425 Magnum 4x4 w/inside lock rings	1995-96	1, 2	78-08503	19,90	78-100338	23,80
425 Magnum 4x4 w/outside lock rings	1995-96	1, 2	78-08507	19,90	78-100811	23,80
425 Magnum 6x6	1997	1, 2	78-08507	19,90	78-100811	23,80
425 Magnum 6x6 w/inside lock rings	1996	1, 2	78-08503	19,90	78-100338	23,80
425 Magnum 6x6 w/outside lock rings	1996	1, 2	78-08507	19,90	78-100811	23,80
425 Xpedition 4x4	2002	1, 2, 3, 4, 5	78-08503	19,90	78-100338	23,80
425 Xpedition 4x4	2000-01	1, 2, 3, 4, 5	78-08503	19,90	78-100338	23,80
450 Sportsman 4x4	2006-07	3, 4	78-08503	19,90	78-100338	23,80
455 Diesel 4x4 prop shaft (from 12/07/00)	2001	3, 4	78-08503	19,90	78-100338	23,80
455 Diesel 4x4 front axle w/inside lock rings		1, 2	78-08503	19,90	78-100338	23,80
455 Diesel 4x4 front axle w/outside lock rings		1, 2	78-08507	19,90	78-100811	23,80
455 Diesel 4x4	2000	1, 2	78-08507	19,90	78-100811	23,80
455 Diesel 4x4	1999	1, 2, 3, 4	78-08503	19,90	78-100338	23,80
		7, 10	78-08502	19,90	78-100995	25,50
		8, 9	78-08501	19,90	78-100507	23,80
500 ATP 4x4	2005	3, 4	78-08503	19,90	78-100338	23,80
500 ATP 4x4	2004	5	78-08507	19,90	78-100811	23,80
		1, 2, 3, 4	78-08503	19,90	78-100338	23,80
		5	78-08507	19,90	78-100811	23,80
500 Big Boss 6x6	1998-99	1, 2	78-08507	19,90	78-100811	23,80
500 Magnum 4x4	2003	3, 4	78-08503	19,90	78-100338	23,80
		5	78-08507	19,90	78-100811	23,80
500 Magnum 4x4 exc. HDS (Visco-Loc)	2001-02	1, 2	78-08507	19,90	78-100811	23,80
		3, 4, 5	78-08503	19,90	78-100338	23,80
500 Magnum 4x4 HDS (Visco-Loc)	2002	3, 4, 5	78-08503	19,90	78-100338	23,80
500 Magnum 4x4 HDS (Visco-Loc)	2001	5	78-08503	19,90	78-100338	23,80
500 Magnum 4x4	1999-00	1, 2	78-08507	19,90	78-100811	23,80
		3, 4	78-08503	19,90	78-100338	23,80
500 Ranger 2x4	2004-09	5, 6	78-08503	19,90	78-100338	23,80
500 Ranger 4x4	2005-09	3, 4, 5, 6	78-08503	19,90	78-100338	23,80
500 Ranger 6x6	2004-05	1, 2, 3, 4, 5, 6	78-08503	19,90	78-100338	23,80
		7, 8	78-08502	19,90	78-100995	25,50
		9, 10	78-08502	19,90	78-100995	25,50
500 Ranger Crew 4x4	2013	3, 4	78-08503	19,90	78-100338	23,80
500 Ranger Crew Mid-Size 4x4	2013	3, 4	78-08503	19,90	78-100338	23,80
500 Ranger EFI 4x4	2011-12	3, 4	78-08503	19,90	78-100338	23,80





RISTINIVELET JATKUU

POLARIS	Vuosim.	Kuva nro.	Bronco	Hinta	Epi	Hinta
500 Ranger HO 4x4	2010	3, 4	78-08503	19,90	78-100338	23,80
500 Ranger Mid-Size 4x4	2013	3, 4	78-08503	19,90	78-100338	23,80
500 Scrambler 4x4	2010	3, 4	78-08503	19,90	78-100338	23,80
500 Scrambler 4x4	1998-09	1, 2	78-08507	19,90	78-100811	23,80
		3, 4	78-08503	19,90	78-100338	23,80
500 Scrambler 4x4	1997	1, 2	78-08507	19,90	78-100811	23,80
500 Sportsman EFI 4x4	2006-09	3, 4, 5, 6	78-08503	19,90	78-100338	23,80
500 Sportsman EFI Touring 4x4	2008-09	3, 4	78-08503	19,90	78-100338	23,80
500 Sportsman HO 4x4	2008-13	3, 4	78-08503	19,90	78-100338	23,80
500 Sportsman HO 4x4	2005-06	3, 4	78-08503	19,90	78-100338	23,80
500 Sportsman HO 4x4	2004	1, 2	78-08503	19,90	78-100338	23,80
prop shaft w/ inside lock rings		3, 4	78-08503	19,90	78-100338	23,80
prop shaft w/ outside lock rings		3, 4	78-08507	19,90	78-100811	23,80
500 Sportsman HO 4x4	2002-03	3, 4	78-08503	19,90	78-100338	23,80
500 Sportsman HO 4x4	2001	1, 2	78-08507	19,90	78-100811	23,80
		3, 4	78-08503	19,90	78-100338	23,80
500 Sportsman HO Touring 4x4	2010-13	3, 4	78-08503	19,90	78-100338	23,80
500 Sportsman 4x4	1999-01	1, 2	78-08507	19,90	78-100811	23,80
		3, 4	78-08503	19,90	78-100338	23,80
500 Sportsman 4x4	1998	1, 2	78-08507	19,90	78-100811	23,80
		3, 4	78-08503	19,90	78-100338	23,80
		7, 10	78-08502	19,90	78-100995	25,50
		8, 9	78-08501	19,90	78-100507	23,80
500 Sportsman 4x4	1997	1, 2, 3, 4	78-08503	19,90	78-100338	23,80
		7, 10	78-08502	19,90	78-100995	25,50
		8, 9	78-08501	19,90	78-100507	23,80
500 Sportsman 4x4	1996	3, 4	78-08503	19,90	78-100338	23,80
front axle w/ inside lock rings		1, 2	78-08503	19,90	78-100338	23,80
front axle w/ outside lock rings		1, 2	78-08507	19,90	78-100811	23,80
		7, 10	78-08502	19,90	78-100995	25,50
		8, 9	78-08501	19,90	78-100507	23,80
500 Sportsman 6x6	2002-08	1, 2, 3, 4	78-08503	19,90	78-100338	23,80
500 Sportsman 6x6	1999-01	1, 2	78-08507	19,90	78-100811	23,80
		3, 4	78-08503	19,90	78-100338	23,80
500 Sportsman X2 4x4	2006-09	3, 4	78-08503	19,90	78-100338	23,80
500 Worker 4x4	1999	1, 2, 3, 4	78-08507	19,90	78-100811	23,80
500 Xplorer 4x4	1997	1, 2, 3, 4	78-08503	19,90	78-100338	23,80
		7, 10	78-08502	19,90	78-100995	25,50
		8, 9	78-08501	19,90	78-100507	23,80
550 Sportsman 4x4	2012-13	3, 4	78-08573	19,90	78-100999	34,00
550 Sportsman 4x4 (built 11/23/10 and after)	2011	3, 4	78-08573	19,90	78-100999	34,00
550 Sportsman 4x4 (built 11/22/10 and before)	2011	3, 4	78-08503	19,90	78-100338	23,80
550 Sportsman XP 4x4	2009-10	3, 4, 5, 6	78-08503	19,90	78-100338	23,80
550 Sportsman EPS 4x4	2012-13	3, 4	78-08573	19,90	78-100999	34,00
550 Sportsman EPS 4x4 (built 11/23/10 and after)	2011	3, 4	78-08573	19,90	78-100999	34,00

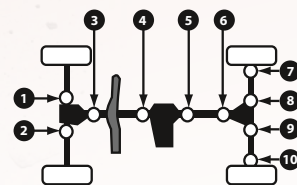

550 Sportsman EPS 4x4 (built 11/22/10 and before)	2011	3, 4	78-08503	19,90	78-100338	23,80
550 Sportsman Touring EPS 4x4	2012-13	3, 4	78-08573	19,90	78-100999	34,00
550 Sportsman Touring EPS 4x4 (built 11/23/10 and after)	2011	3, 4	78-08573	19,90	78-100999	34,00
550 Sportsman Touring EPS 4x4 (built 11/22/10 and before)	2011	3, 4	78-08503	19,90	78-100338	23,80
550 Sportsman Touring EPS 4x4	2010	3, 4	78-08503	19,90	78-100338	23,80
550 Sportsman X2 4x4	2013	3, 4	78-08573	19,90	78-100999	34,00
550 Sportsman X2 4x4 (built 11/23/10 and after)	2011-12	3, 4	78-08573	19,90	78-100999	34,00
550 Sportsman X2 4x4 (built 11/22/10 and before)	2011	3, 4	78-08503	19,90	78-100338	23,80
550 Sportsman X2 4x4	2010	3, 4, 5, 6	78-08503	19,90	78-100338	23,80
570 RZR 4x4	2012-13	3, 4	78-08503	19,90	78-100338	23,80
600 Sportsman 4x4	2005	3, 4, 5, 6	78-08503	19,90	78-100338	23,80
600 Sportsman 4x4	2003-04	1, 2, 3, 4, 5, 6	78-08503	19,90	78-100338	23,80
700 Ranger EFI 6x6	2006-09	3, 4, 5, 6	78-08503	19,90	78-100338	23,80
700 Ranger XP 4x4	2005-09	5, 6	78-08503	19,90	78-100338	23,80
700 Sportsman EFI 4x4	2005-07	3, 4, 5, 6	78-08503	19,90	78-100338	23,80
700 Sportsman EFI 4x4	2004	1, 2, 3, 4, 5, 6	78-08503	19,90	78-100338	23,80
700 Sportsman 4x4	2005-06	3, 4, 5, 6	78-08503	19,90	78-100338	23,80
700 Sportsman 4x4	2002-04	1, 2, 3, 4, 5, 6	78-08503	19,90	78-100338	23,80
700 Sportsman MV7 4x4	2005	3, 4, 5, 6	78-08503	19,90	78-100338	23,80
800 Ranger Crew 4x4	2010-13	3, 4	78-08503	19,90	78-100338	23,80
800 Ranger EFI 4x4	2013	3, 4	78-08503	19,90	78-100338	23,80
800 Ranger EFI Mid-Size 4x4	2013	3, 4	78-08503	19,90	78-100338	23,80
800 Ranger XP 4x4	2010-12	3, 4	78-08503	19,90	78-100338	23,80
800 Ranger 6x6	2010-13	3, 4, 5, 6	78-08503	19,90	78-100338	23,80
800 RZR 4x4	2008-13	3, 4	78-08503	19,90	78-100338	23,80
800 RZR 4 4x4	2011-13	3, 4	78-08503	19,90	78-100338	23,80
800 RZR S 4x4	2008-13	3, 4	78-08503	19,90	78-100338	23,80
800 Sportsman EFI 4x4	2011-13	3, 4	78-08503	19,90	78-100338	23,80
800 Sportsman EFI 4x4	2005-10	3, 4, 5, 6	78-08503	19,90	78-100338	23,80
800 Sportsman EFI 6x6	2009-13	3, 4, 5, 6	78-08503	19,90	78-100338	23,80
800 Sportsman EFI Touring 4x4	2008-09	3, 4	78-08503	19,90	78-100338	23,80
800 Sportsman X2 4x4	2007-09	3, 4	78-08503	19,90	78-100338	23,80
850 Scrambler HO 4x4	2013	3, 4	78-08573	19,90	78-100999	34,00
		5, 6	78-08503	19,90	78-100338	23,80
850 Scrambler HO EPS 4x4	2013	3, 4	78-08573	19,90	78-100999	34,00
		5, 6	78-08503	19,90	78-100338	23,80
850 Sportsman Touring HO EPS 4x4	2013	3, 4	78-08573	19,90	78-100999	34,00

RISTINIVELET JATKU

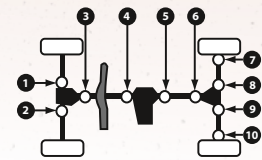

POLARIS	Vuosim.	Kuva nro.	Bronco	Hinta	Epi	Hinta
850 Sportsman Touring EPS 4x4 (built 11/23/10 and after)	2011-12	3, 4	78-08573	19,90	78-100999	34,00
850 Sportsman Touring EPS 4x4 (built 11/22/10 and before)	2011	3, 4	78-08503	19,90	78-100338	23,80
850 Sportsman Touring EPS 4x4	2010	3, 4	78-08503	19,90	78-100338	23,80
850 Sportsman X2 4x4	2011	3, 4	78-08573	19,90	78-100999	34,00
850 Sportsman XP 4x4	2010-13	3, 4	78-08573	19,90	78-100999	34,00
		5, 6	78-08503	19,90	78-100338	23,80
850 Sportsman XP HO EPS 4x4	2013	3, 4	78-08573	19,90	78-100999	34,00
850 Sportsman XP EPS 4x4	2010-12	3, 4	78-08573	19,90	78-100999	34,00
		5, 6	78-08503	19,90	78-100338	23,80
900 Ranger Diesel 4x4	2011-13	3, 4, 5, 6	78-08503	19,90	78-100338	23,80
900 Ranger Diesel Crew 4x4	2011-13	3, 4, 5, 6	78-08503	19,90	78-100338	23,80
900 RZR XP 4x4	2011-13	1, 2	78-08503	19,90	78-100338	23,80
900 RZR XP 4 4x4	2012-13	3, 4	78-08503	19,90	78-100338	23,80
Ranger 6x6	1999	3, 4, 5, 6	78-08503	19,90	78-100338	23,80
		7, 8, 9, 10	78-08502	19,90	78-100995	25,50
Ranger EV 4x4	2010-13	1, 2	78-08503	19,90	78-100338	23,80
Ranger EV LSV 4x4	2011-12	1, 2	78-08503	19,90	78-100338	23,80
Ranger TM 2x4	2004-06	5, 6	78-08503	19,90	78-100338	23,80

SUZUKI	Vuosim.	Kuva nro.	Bronco	Hinta	Epi	Hinta
250 Ozark 2x4	2012	5	78-08515	19,90	78-100285	23,80
250 Ozark 2x4	2002-09	5	78-08515	19,90	78-100285	23,80
250 Quad Runner 2x4	2001	7, 10	78-08537	19,90	78-100227	23,80
		8, 9			78-100295	34,00
250 Quad Runner 2x4	1995-00	7, 10	78-08537	19,90	78-100227	23,80
250 Quad Runner 2x4	1988-94	7, 10	78-08537	19,90	78-100227	23,80
		8, 9	78-08536	19,90	78-100223	23,80
250 Quad Runner 4x4	2001-02	7, 10	78-08537	19,90	78-100227	23,80
		8, 9			78-100295	34,00
250 Quad Runner 4x4	1994-00	5	78-08515	19,90	78-100285	23,80
		7, 10	78-08537	19,90	78-100227	23,80
250 Quad Runner 4x4	1988-93	7, 10	78-08537	19,90	78-100227	23,80
		8, 9	78-08536	19,90	78-100223	23,80
		5	78-08514	19,90	78-100270	26,00
250 Quad Runner 4x4	1987	7, 8, 9, 10	78-08537	19,90	78-100227	23,80
		5	78-08514	19,90	78-100270	26,00
250 Quad Sport 2x4	2004-09	5	78-08515	19,90	78-100285	23,80
300 King Quad 4x4	2001-02	7, 10	78-08538	19,90	78-100280	23,80
		8, 9			78-100295	34,00
		5	78-08515	19,90	78-100285	23,80
300 King Quad 4x4	1996-00	7, 10	78-08538	19,90	78-100280	23,80
		5	78-08514	19,90	78-100270	26,00
300 King Quad 4x4	1991-93	7, 10	78-08538	19,90	78-100280	23,80
		8, 9	78-08536	19,90	78-100223	23,80
300 Quad Runner 4x4	1995	7, 10	78-08538	19,90	78-100280	23,80
		5	78-08514	19,90	78-100270	26,00
300 Quad Runner 4x4	1994	7, 10	78-08538	19,90	78-100280	23,80
		8, 9	78-08536	19,90	78-100223	23,80
		5	78-08514	19,90	78-100270	26,00
400 Eiger 2x4	2002-07	5	78-08515	19,90	78-100285	23,80
400 Eiger 4x4	2002-07	3, 5, 6	78-08515	19,90	78-100285	23,80
400 King Quad 2x4	2008-09	5	78-08515	19,90	78-100285	23,80
400 King Quad 4x4	2008-12	3, 5, 6	78-08515	19,90	78-100285	23,80

450 King Quad 4x4	2008-10	4	78-08518	20,90	78-100275	34,00
		6	78-08514	19,90	78-100270	26,00
500 King Quad 4x4	2009-11	4	78-08518	20,90	78-100275	34,00
		6	78-08514	19,90	78-100270	26,00
500 Quad Master 4x4	2001	3	78-08515	19,90	78-100285	23,80
		5, 6	78-08514	19,90	78-100270	26,00
500 Quad Master 4x4	2000	3, 5	78-08514	19,90	78-100270	26,00
500 Quad Runner 4x4	2002	3, 5, 6	78-08515	19,90	78-100285	23,80
500 Quad Runner 4x4	2001	4, 6	78-08515	19,90	78-100285	23,80
500 Quad Runner 4x4	1998-00	5	78-08514	19,90	78-100270	26,00
500 Vinson 4x4	2002-07	3, 5	78-08515	19,90	78-100285	23,80
		6	78-08514	19,90	78-100270	26,00
620 QUV 4x4	2005	5, 6	78-08513	19,90	78-100220	23,80
		7, 8, 9, 10	78-08539	19,90	78-100240	24,80
700 King Quad 4x4	2005-07	4	78-08518	20,90	78-100275	34,00
		6	78-08514	19,90	78-100270	26,00
700 Twin Peaks 4x4	2004-05	5	78-08534	4,00	78-100230	23,80
750 King Quad 4x4	2008-13	3, 4	78-08518	20,90	78-100275	34,00
		6	78-08514	19,90	78-100270	26,00

YAMAHA	Vuosim.	Kuva nro.	Bronco	Hinta	Epi	Hinta
50 Raptor 2x4	2006-08	5			78-100998	42,00
80 Grizzly 2x4	2006-08	5			78-100998	42,00
80 Raptor 2x4	2006-08	5			78-100998	42,00
225 Moto-4 2x4	1989-91	5	78-08509	19,90	78-100600	25,80
250 Moto-4 2x4	1986-88	5	78-08509	19,90	78-100600	25,80
250 Bear Tracker 2x4	1999-04	5	78-08509	19,90	78-100600	25,80
250 Big Bear 2x4	2007-09	5	78-08500	19,90	78-100290	23,80
250 Bruin 2x4	2006	5	78-08500	19,90	78-100290	23,80
250 Timberwolf 2x4	1992-98	5	78-08509	19,90	78-100600	25,80
250 Timberwolf 4x4	1994-00	3, 4	78-08516	19,90	78-100395	21,80
		5, 6	78-08509	19,90	78-100600	25,80
350 Big Bear 4x4	1987-99	3, 4	78-08516	19,90	78-100395	21,80
		5, 6	78-08509	19,90	78-100600	25,80
350 Big Bear 4x4	1986	3, 4	78-08500	19,90	78-100290	23,80
350 Grizzly 2x4	2007-11	5	78-08500	19,90	78-100290	23,80
350 Grizzly 4x4	2013	5	78-08500	19,90	78-100290	23,80
350 Grizzly 4x4 exc IRS	2007-12	5	78-08500	19,90	78-100290	23,80
350 Grizzly 4x4 w/IRS	2007-11	3, 4, 5, 6	78-08500	19,90	78-100290	23,80
350 Wolverine 2x4	2006-09	5	78-08500	19,90	78-100290	23,80
350 Wolverine 4x4	1995-98	3, 4	78-08500	19,90	78-100290	23,80
		5, 6	78-08509	19,90	78-100600	25,80
400 Big Bear 4x4 w/IRS	2007-12	3, 4, 5, 6	78-08500	19,90	78-100290	23,80
400 Big Bear 4x4	2006	3, 4	78-08500	19,90	78-100290	23,80
400 Grizzly 4x4 exc IRS	2007	5, 6	78-08500	19,90	78-100290	23,80
400 Grizzly 4x4 w/IRS	2007-08	3, 4, 5, 6	78-08500	19,90	78-100290	23,80
400 Kodiak 4x4	2005-06	5, 6	78-08500	19,90	78-100290	23,80
400 Kodiak 4x4	1998-99	3, 4	78-08500	19,90	78-100290	23,80
400 Kodiak 4x4	1993-97	3, 4	78-08516	19,90	78-100395	21,80
		5, 6	78-08509	19,90	78-100600	25,80
450 Grizzly 4x4	2009-13	3, 4, 5, 6	78-08500	19,90	78-100290	23,80
450 Grizzly EPS 4x4	2013	3, 4, 5, 6	78-08500	19,90	78-100290	23,80
450 Kodiak 4x4	2003-06	3, 4, 5, 6	78-08500	19,90	78-100290	23,80
450 Rhino 4x4	2006-09	3, 4	78-08500	19,90	78-100290	23,80
450 Wolverine 4x4	2007-10	5	78-08500	19,90	78-100290	23,80
600 Grizzly 4x4	2009-01	3, 4, 5, 6	78-08516	19,90	78-100395	21,80
600 Grizzly 4x4	1998	3, 4	78-08516	19,90	78-100395	21,80
		5, 6	78-08509	19,90	78-100600	25,80
660 Grizzly 4x4	2002	3, 4	78-08516	19,90	78-100395	21,80
660 Rhino 4x4	2004-07	3, 4	78-08500	19,90	78-100290	23,80
700 Rhino 4x4	2008-13	3, 4	78-08500	19,90	78-100290	23,80



Vanteet ja renkaat



Talvutuotteet



Vinsit



Laukut ja tuulisuojat



Sähköosat



Jousitus ja voimansiirto



Pakoputket ja suutinsarjat



Ohjaus



Rungon osat ja peitteet



Jarrupalat ja rattaat



Moottori



Variaattorin osat



Maatalous-tarvikkeet



Kärryt ja reet

ATV





PALLONIVELET

EPI valmistettu USA:ssa, Bronco Taiwanissa.



Vanteet ja renkaat



Talvituotteet



Vinssit



Laukut ja tuulisuojat



Sähköosat



Jousitus ja voimansiirto



Pakoputket ja suutinsarjat



Ohjauk



Rungon osat ja peitteet



Jarrupalat ja ratat



Moottori



Variaattorin osat



Maatalous-tarvikkeet



Kärryt ja reet



78-04024



78-08554



78-08556



78-08580



78-08581



78-08582



78-08800



78-08801



78-08803



78-08806



78-08812



ARCTIC CAT	ALEMPI	HINTA	YLEMPI	HINTA	ALEMPI	HINTA	YLEMPI	HINTA
250 2x4 99-05	78-351032	33,30	78-351032	33,30	78-08580	25,30	78-08580	25,30
250 4x4 01/03-05	78-351032	33,30	78-351032	33,30	78-08580	25,30	78-08580	25,30
300 2x4 98-04	78-351032	33,30	78-351032	33,30	78-08580	25,30	78-08580	25,30
300 4x4 98-05	78-351032	33,30	78-351032	33,30	78-08580	25,30	78-08580	25,30
366 FIS w/at 08-11	78-351032	33,30	78-351032	33,30	78-08580	25,30	78-08580	25,30
375 2x4/4x4 w/AT 02	78-351032	33,30	78-351032	33,30	78-08580	25,30	78-08580	25,30
400 2x4 FIS 03-04	78-351032	33,30	78-351032	33,30	78-08580	25,30	78-08580	25,30
400 2x4 98-01	78-351032	33,30	78-351032	33,30	78-08580	25,30	78-08580	25,30
400 2x4 98-01	78-351032	33,30	78-351032	33,30	78-08580	25,30	78-08580	25,30
400 4x4 w/AT 03-04	78-351032	33,30	78-351032	33,30	78-08580	25,30	78-08580	25,30
400 4x4 w/MT 01-04	78-351032	33,30	78-351032	33,30	78-08580	25,30	78-08580	25,30
400 4x4 98-00	78-351032	33,30	78-351032	33,30	78-08580	25,30	78-08580	25,30
400 FIS AT/MT 4x4 02-08	78-351032	33,30	78-351032	33,30	78-08580	25,30	78-08580	25,30
400 TBX 4x4 04/06	78-351032	33,30	78-351032	33,30	78-08580	25,30	78-08580	25,30
400 TRV 07	78-351032	33,30	78-351032	33,30	78-08580	25,30	78-08580	25,30
400 VP 4x4 06	78-351032	33,30	78-351032	33,30	78-08580	25,30	78-08580	25,30
450 4x4 10-12	78-351032	33,30	78-351032	33,30	78-08580	25,30	78-08580	25,30
454 2x4 97-98	78-351032	33,30	78-351032	33,30	78-08580	25,30	78-08580	25,30
454 4x4 96-98	78-351032	33,30	78-351032	33,30	78-08580	25,30	78-08580	25,30
500 4x4 98-01	78-351032	33,30	78-351032	33,30	78-08580	25,30	78-08580	25,30
500 4x4 w/AT 02	78-351032	33,30	78-351032	33,30	78-08580	25,30	78-08580	25,30
500 FIS AT 4x4 02-09	78-351032	33,30	78-351032	33,30	78-08580	25,30	78-08580	25,30
500 FIS TBX 4x4 02-06	78-351032	33,30	78-351032	33,30	78-08580	25,30	78-08580	25,30
500 FIS TRV 4x4 03-08	78-351032	33,30	78-351032	33,30	78-08580	25,30	78-08580	25,30
500 TBX 4x4 04	78-351032	33,30	78-351032	33,30	78-08580	25,30	78-08580	25,30
500 TBX 4x4 w/AT 02-03	78-351032	33,30	78-351032	33,30	78-08580	25,30	78-08580	25,30
500 TRV 4x4 03-04	78-351032	33,30	78-351032	33,30	78-08580	25,30	78-08580	25,30
550 H1 EFI 4x4 09-12	78-351032	33,30	78-351032	33,30	78-08580	25,30	78-08580	25,30
550 H1 Prowler XT 4x4 09-13	78-351032	33,30	78-351032	33,30	78-08580	25,30	78-08580	25,30
550 TRV 4x4 09-12	78-351032	33,30	78-351032	33,30	78-08580	25,30	78-08580	25,30
650 H1 4x4 05-10	78-351032	33,30	78-351032	33,30	78-08580	25,30	78-08580	25,30
650 H1 Prowler XT 4x4 06-09	78-351032	33,30	78-351032	33,30	78-08580	25,30	78-08580	25,30
650 V2 4x4 04-06	78-351032	33,30	78-351032	33,30	78-08580	25,30	78-08580	25,30
700 EFI 4x4 07-08	78-351032	33,30	78-351032	33,30	78-08580	25,30	78-08580	25,30
700 Diesel 4x4 07-12	78-351032	33,30	78-351032	33,30	78-08580	25,30	78-08580	25,30
700 H1 EFI 4x4 08-12	78-351032	33,30	78-351032	33,30	78-08580	25,30	78-08580	25,30
700 H1 Prowler XTX 4x4 08	78-351032	33,30	78-351032	33,30	78-08580	25,30	78-08580	25,30
700 MUD PRO H2 4x4	78-351032	33,30	78-351032	33,30	78-08580	25,30	78-08580	25,30
1000 Thunder Cat 4x4 08-12	78-351032	33,30	78-351032	33,30	78-08580	25,30	78-08580	25,30
1000 MUD PRO H2 4x4 10-13	78-351032	33,30	78-351032	33,30	78-08580	25,30	78-08580	25,30
1000 WILD CAT 2013-	78-350046	33,30	78-350046	33,30				

ATV



BRONCO
ATV COMPONENTS



CAN-AM	ALEMPI	HINTA	YLEMPI	HINTA	ALEMPI	HINTA	YLEMPI	HINTA
330 Outlander 04-05								
400 Outlander,Max 06-14					78-08812	26,30	78-08806	26,30
500 Outlander,Max 07-12					78-08812	26,30	78-08806	26,30
500 Outlander 13-14	78-350045	33,30	78-350043	33,30				
500 Renegade 4x4 08-12	78-351039	43,40						
500 Renegade 4x4 13-14	78-350045	33,30	78-350043	33,30				
500 Traxter 99-05	78-351039	43,40	78-351039	43,40				
650 Outlander 4x4 07-12			78-351039	43,40	78-08812	26,30		
650 Outlander 4x4 13-14	78-350045	33,30	78-350043	33,30				
650 Quest 02-04	78-351039	43,40	78-351039	43,40				
650 Traxter 04-05	78-351039	43,40	78-351039	43,40				
800 Commander 11-13	78-350045	33,30	78-350043	33,30				
800 Outlander 4x4 13-14	78-350045	33,30	78-350043	33,30				
800 Outlander 4x4 06-12			78-351039	43,40	78-08812	26,30		
800 Renegade 4x4 07-11	78-351039	43,40	78-351039	43,40				
800 Renegade 4x4 12-14	78-350045	33,30	78-350043	33,30				
1000 Commander 11-13	78-350045	33,30	78-350043	33,30				
1000 Outlander 4x4 12-14	78-350045	33,30	78-350043	33,30				
1000 Renegade 4x4 12-14	78-350045	33,30	78-350043	33,30				
HONDA	ALEMPI	HINTA	YLEMPI	HINTA	ALEMPI	HINTA	YLEMPI	HINTA
TRX 250 Recon 97-14	78-351008	44,50	78-351009	33,30			78-04023	25,30
TRX 250 EX Sportrax 01-12	78-351014	42,40	78-351009	33,30			78-04023	25,30
TRX 300 Fourtrax 93-00	78-351009	33,30	78-351009	33,30	78-04023	25,30	78-04023	25,30
TRX 300 FW Fourtrax 88-00	78-351009	33,30	78-351009	33,30	78-04023	25,30	78-04023	25,30
TRX 350 FE/FM Fourtrax Rancher 00-06	78-351009	33,30	78-351015	36,30	78-04023	25,30	78-04024	25,30
TRX 350 TE/TM Fourtrax Rancher 00-06	78-351009	33,30	78-351015	36,30	78-04023	25,30	78-04024	25,30
TRX 400 FA/FGA Fourtrax Rancher 4x4 04-06	78-351009	33,30	78-351015	36,30	78-04023	25,30	78-04024	25,30
TRX 400 FW Fourtrax Foreman 4x4 95-03	78-351009	33,30	78-351009	33,30	78-04023	25,30	78-04023	25,30
TRX 420 FA/FPA 09-13	78-351009	33,30	78-351015	36,30	78-04023	25,30	78-04024	25,30
TRX 420 FE/FM 14-	78-351015	36,30	78-351015	36,30	78-04024	25,30	78-04024	25,30
TRX 420 FE/FM 07-13	78-351009	33,30	78-351015	36,30	78-04023	25,30	78-04024	25,30
TRX 420 TE/TM 07-13	78-351009	33,30	78-351015	36,30	78-04023	25,30	78-04024	25,30
TRX 450 ES/S 98-01	78-351015	36,30	78-351015	36,30	78-04024	25,30	78-04024	25,30
TRX 450 FE/FM 02-04	78-351015	36,30	78-351015	36,30	78-04024	25,30	78-04024	25,30
TRX 500 FA 01-14	78-351015	36,30	78-351015	36,30	78-04024	25,30	78-04024	25,30
TRX 500 FE/FM 05-13	78-351015	36,30	78-351015	36,30	78-04024	25,30	78-04024	25,30
TRX 500 FGA 01-13	78-351015	36,30	78-351015	36,30	78-04024	25,30	78-04024	25,30
TRX 500 FPE/FPM 08-13	78-351015	36,30	78-351015	36,30	78-04024	25,30	78-04024	25,30
TRX 500 FPA 09-14	78-351015	36,30	78-351015	36,30	78-04024	25,30	78-04024	25,30
TRX 500 TM 05-13	78-351015	36,30	78-351015	36,30	78-04024	25,30	78-04024	25,30
TRX 650 Rincon 03-05	78-351015	36,30	78-351015	36,30	78-04024	25,30	78-04024	25,30
TRX 680 Rincon 06-14	78-351015	36,30	78-351015	36,30	78-04024	25,30	78-04024	25,30
KAWASAKI	ALEMPI	HINTA	YLEMPI	HINTA	ALEMPI	HINTA	YLEMPI	HINTA
KSF 250 Mojave 87-04	78-351016	42,40	78-351017	42,40				
KXF 250 Tecate 87-88	78-351016	42,40	78-351017	42,40				
KEF 300 Lakota 95-03	78-351016	42,40	78-351017	42,40				
KLF 300 A Bayou 86-07	78-351018	42,40	78-351018	42,40				
KLF 300 B Bayou 88-04	78-351018	42,40	78-351018	42,40				
KLF 300 C Bayou 4x4 89-04	78-351016	42,40	78-351017	42,40				
KVF 300 A Prairie 4x4 99-02	78-351016	42,40						
KVF 300 B Prairie 2x4 02	78-351020	33,30						
KVF 300 B Prairie 2x4 99-01	78-351016	42,40						
KVF 360 A/C Prairie 4x4 06-09	78-351033	47,90			78-08582	26,50		
KVF 360 A/B/C Prairie 4x4 03-05	78-351020	33,30						
KVF 360 B Prairie 4x4 06-13	78-351033	47,90			78-08582	26,50		
KFX 400 04-06			78-351019	32,00				
KLF 400 Bayou 93-97	78-351016	42,40	78-351017	42,40				
KLF 400 B Bayou 98-99	78-351016	42,40	78-351017	42,40				
KVF 400 A Prairie 4x4 97-98	78-351016	42,40						
KVF 400 B Prairie 98	78-351016	42,40						
KVF 400 C/D Prairie 01-02	78-351020	33,30						
KVF 400 C/D Prairie 99-00	78-351016	42,40						
KFX 450 R 08-14	78-351033	47,90	78-351033	47,90	78-08582	26,50	78-08582	26,50
KVF 650 Brute Force 05-13	78-351033	47,90			78-08582	26,50		
KVF 650i Brute Force 06-13	78-351033	47,90	78-351033	47,90	78-08582	26,50	78-08582	26,50
KVF 650 Prairie 02-03	78-351020	33,30						
KFX 700 04-09	78-351033	47,90	78-351033	47,90	78-08582	26,50	78-08582	26,50
KVF 700 Prairie 04-06	78-351033	47,90			78-08582	26,50		
KVF 750 Brute Force 05-14	78-351033	47,90	78-351033	47,90	78-08582	26,50	78-08582	26,50
750 Teryx 4x4 08-14	78-351033	47,90	78-351033	47,90	78-08582	26,50	78-08582	26,50



Vanteet ja renkaat



Talvutuotteet



Vinssit



Laukut ja tuulisuojat



Sähköosat



Jousitus ja voimansiirto



Pakoputket ja suutinsarjat



Ohjaus



Rungon osat ja peitteet



Jarrupalat ja rattaat



Moottori



Variaattorin osat



Maatalous-tarvikkeet



Kärryt ja reet

ATV





PALLONIVELET JATKUU



BRONCO
ATV COMPONENTS



Vanteet ja renkaat



Talvituotteet



Vinssit



Laukut ja tuulisuojat



Sähköosat



Jousitus ja voimansiirto



Pakoputket ja suutinsarjat



Ohjaus



Rungon osat ja peitteet



Jarrupalat ja rattaat



Moottori



Variaattorin osat



Maatalous-tarvikkeet



Kärryt ja reet

POLARIS	ALEMPI	HINTA	YLEMPI	HINTA	ALEMPI	HINTA	YLEMPI	HINTA
200 Phoenix 2x4 05-14	78-351031	32,00	78-351031	32,00				
200 Sawtooth 2x4 06-07	78-351031	32,00	78-351031	32,00				
250 Trail Blazer 2x4 01-06	78-351030	35,30			78-08554	28,20		
250 Xplorer 4x4 01-02	78-351030	35,30			78-08554	28,20		
325 Magnum 2x4 / 4x4 01-02	78-351030	35,30			78-08554	28,20		
325 Trail Boss 2x4 01-02	78-351030	35,30			78-08554	28,20		
330 ATP 4x4 04-05	78-351030	35,30			78-08554	28,20		
330 Magnum 2x4 03-05	78-351030	35,30			78-08554	28,20		
330 Magnum 4x4 03-06	78-351030	35,30			78-08554	28,20		
330 Trail Blazer 2x4 08-11	78-351030	35,30			78-08554	28,20		
330 Trail Boss 2x4 03-09	78-351030	35,30			78-08554	28,20		
400 Scrambler 4x4 95-02	78-351030	35,30			78-08554	28,20		
400 Sportman 400 HO 11-14	78-351030	35,30			78-08554	28,20		
400 Sportsman 4x4 94-05	78-351030	35,30			78-08554	28,20		
400 Trail Blazer 2x4 03	78-351030	35,30			78-08554	28,20		
400 Ranger 4x4 2012-14	78-351030	35,30						
400 Ranger HO 4x4 2010-11	78-351030	35,30			78-08554	28,20		
400 Xplorer 4x4 01-02	78-351030	35,30			78-08554	28,20		
425 Xpedition 4x4 02	78-351030	35,30			78-08554	28,20		
450 Outlaw 2x4 08-10			78-351035	47,90			78-08803	26,50
450 Sportsman 4x4 06-07	78-351030	35,30			78-08554	28,20		
455 Diesel 4x4 99-01	78-351030	35,30			78-08554	28,20		
500 ATP 4x4 04-05	78-351030	35,30			78-08554	28,20		
500 Magnum 4x4 01-02	78-351030	35,30			78-08554	28,20		
500 Magnum RMK 4x4 02	78-351030	35,30			78-08554	28,20		
500 Outlaw 2x4 06-07			78-351035	47,90			78-08803	26,50
500 Predator 2x4 07			78-351035	47,90			78-08803	26,50
500 Predator 2x4 03-07			78-351035	47,90			78-08803	26,50
500 Ranger 2x4 04-09	78-351030	35,30			78-08554	28,20		
500 Ranger 4x4 04-07	78-351030	35,30			78-08554	28,20		
500 Ranger EFI 4x4 06-08	78-351030	35,30			78-08554	28,20		
500 Ranger EFI 4x4 09	78-350040	68,50	78-350040	68,50	78-08804	26,50	78-08804	26,50
500 Ranger HO 4x4 10	78-350040	68,50	78-350040	68,50	78-08804	26,50	78-08804	26,50
500 Ranger EFI 4x4 11-12	78-351030	35,30			78-08554	28,20		
500 Ranger 6x6 04-05	78-351030	35,30			78-08554	28,20		
500 Scrambler 2x4 01-02	78-351030	35,30			78-08554	28,20		
500 Scrambler 4x4 01-12	78-351030	35,30			78-08554	28,20		
500 Sportsman 4x4 01	78-351030	35,30			78-08554	28,20		
500 Sportsman 6x6 01-08	78-351030	35,30			78-08554	28,20		
500 Sportsman EFI 4x4 06-09	78-351030	35,30			78-08554	28,20		
500 Sportsman EFI Touring 4x4 08-12	78-351030	35,30			78-08554	28,20		
500 Sportsman EFI X2 4x4 07-09	78-351030	35,30			78-08554	28,20		
500 Sportsman X2 4x4 06	78-351030	35,30			78-08554	28,20		
500 Sportsman HO 4x4 01-09	78-351030	35,30			78-08554	28,20		
525 Outlaw IRS 2x4 08-11			78-351035	47,90			78-08803	26,50
525 Outlaw S 2x4 08-11			78-351035	47,90			78-08803	26,50
550 Sportsman XP 09-	78-350040	68,50	78-350040	68,50	78-08804	26,50	78-08804	26,50
570 Ranger 14-	78-351030	35,30						
570 Sportman 14-	78-351030	35,30						
600 Sportsman 4x4 03-05	78-351030	35,30			78-08554	28,20		
700 Ranger Crew 4x4 08-09	78-351030	35,30			78-08554	28,20		
700 Ranger EFI 6x6 06-09	78-351030	35,30			78-08554	28,20		
700 Ranger XP 4x4 05-08	78-351030	35,30			78-08554	28,20		
700 Ranger XP 4x4 09	78-350040	68,50	78-350040	68,50	78-08804	26,50	78-08804	26,50
700 Sportsman 4x4 02-06	78-351030	35,30			78-08554	28,20		
700 Sportsman EFI 4x4 04-07	78-351030	35,30			78-08554	28,20		
700 Sportsman EFI X2 4x4 08	78-351030	35,30			78-08554	28,20		
700 MV7 4x4 05	78-351030	35,30			78-08554	28,20		
800 Sportsman EFI 4x4 09-12	78-351030	35,30			78-08554	28,20		
800 Sportsman EFI HO 4x4 08	78-351030	35,30			78-08554	28,20		
800 Sportsman EFI 4x4 05-07	78-351030	35,30			78-08554	28,20		
800 Sportsman EFI 6x6 09-12	78-351030	35,30			78-08554	28,20		
800 Sportsman EFI Touring 4x4 08-09	78-351030	35,30			78-08554	28,20		
800 Sportsman EFI X2 4x4 07-09	78-351030	35,30			78-08554	28,20		
800 Ranger XP 4x4 10-12	78-350040	68,50	78-350040	68,50	78-08804	26,50	78-08804	26,50
850 Sportsman XP 09-	78-350040	68,50	78-350040	68,50	78-08804	26,50	78-08804	26,50
Ranger TM 2x4 04-06	78-351030	35,30			78-08554	28,20		
900 Ranger DIESEL 11	78-350040	68,50	78-350040	68,50	78-08804	26,50	78-08804	26,50
Kaikki muut mallit 2x4 / 4x4 89-00	78-351030	35,30			78-08554	28,20		

ATV

PALLONIVELET JATKUU



SUZUKI	ALEMPI	HINTA	YLEMPI	HINTA	ALEMPI	HINTA	YLEMPI	HINTA
LT 230 E 87-93	78-351022	37,50			78-08556	28,20		
LT 230 GE 85-86	78-351022	37,50			78-08556	28,20		
LT 230 S 85-88	78-351022	37,50			78-08556	28,20		
LT-F 230 86-87	78-351022	37,50			78-08556	28,20		
LT 250 EF 85-86	78-351022	37,50			78-08556	28,20		
LT 250 R 85-92	78-351022	37,50			78-08556	28,20		
LT 250 4WD 87-98	78-351022	37,50	78-351022	37,50	78-08556	28,20	78-08556	28,20
LT-F 250 88-01	78-351022	37,50	78-351022	37,50	78-08556	28,20	78-08556	28,20
LT-F 250 F 99-02 (Except Ozark)	78-351022	37,50	78-351022	37,50	78-08556	28,20	78-08556	28,20
LT-F 250 4WD 97-98	78-351022	37,50	78-351022	37,50	78-08556	28,20	78-08556	28,20
LT-F 250 Ozark 05-12			78-351019	32,00			78-08581	25,30
LT-Z 250 04-08	78-351029	33,30	78-351029	33,30				
LT 300 E 87-89	78-351022	37,50			78-08556	28,20		
LT-F 300 4WDX King Quad 91-98	78-351022	37,50	78-351022	37,50	78-08556	28,20		
LT-F 300 F King Quad 99-02	78-351022	37,50	78-351022	37,50	78-08556	28,20		
LT-A 400 Eiger 2WD 02-04	78-351026	29,50	78-351026	29,50				
LT-A 400 F Eiger 4WD 02-07	78-351026	29,50	78-351026	29,50				
LT-A 400 King Quad Auto 2WD 08-13	78-351026	29,50	78-351026	29,50				
LT-A 400 F King Quad Auto 4WD 08-13	78-351026	29,50	78-351026	29,50				
LT-F 400 Eiger 2WD 02-04/07	78-351026	29,50	78-351026	29,50				
LT-F 400 F Eiger 4WD 02-07	78-351026	29,50	78-351026	29,50				
LT-F 400 King Quad STD 2WD 08-13	78-351026	29,50	78-351026	29,50				
LT-Z 400 05-12			78-351019	32,00			78-08581	25,30
LT-A 450 X King Quad 07-10	78-351019	32,00	78-351019	32,00	78-08581	25,30	78-08581	25,30
LT 500 R 87-90	78-351022	37,50			78-08556	28,20		
LT-A 500 KINQ QUAD 09-11	78-351019	32,00	78-351019	32,00	78-08581	25,30	78-08581	25,30
LT-A 500 F Quad Master Auto 00-01	78-351022	37,50			78-08556	28,20		
LT-F 500 F Quad Master 00-01	78-351022	37,50			78-08556	28,20		
LT-F 500 F Quad Runner 98-99	78-351022	37,50			78-08556	28,20		
LT-A 500 F Vinson 02-07	78-351026	29,50	78-351026	29,50				
LT-F 500 F Vinson 03-07	78-351026	29,50	78-351026	29,50				
LT-F 500 F Vinson 02	78-351022	37,50			78-08556	28,20		
LTA 700 X King Quad 05-07	78-351019	32,00	78-351019	32,00	78-08581	25,30	78-08581	25,30
LTV 700 F Twin Peaks 04-06	78-351033	47,90	78-351033	47,90				
LTA 750 X King Quad 08-11	78-351019	32,00	78-351019	32,00	78-08581	25,30	78-08581	25,30
YAMAHA	ALEMPI	HINTA	YLEMPI	HINTA	ALEMPI	HINTA	YLEMPI	HINTA
YFM 250 Big Bear 07-08					78-08554	28,20	78-08554	28,20
YFM 350 A Bruin 2x4 04-06	78-351009	33,30	78-351009	33,30	78-04023	25,30	78-04023	25,30
YFM 350 FA Bruin 4x4 04-06	78-351009	33,30	78-351009	33,30	78-04023	25,30	78-04023	25,30
YFM 350 Grizzly IRS 4x4 07-14	78-351009	33,30	78-351009	33,30	78-04023	25,30	78-04023	25,30
YFM 350 FGW Grizzly 4x4 07-14	78-351009	33,30	78-351009	33,30	78-04023	25,30	78-04023	25,30
YFM 350 GW Grizzly 2x4 07-08	78-351009	33,30	78-351009	33,30	78-04023	25,30	78-04023	25,30
YFM 350 ER Moto 4 89-95								
YFM 350 Wolverine 06-09	78-351009	33,30	78-351009	33,30	78-04023	25,30	78-04023	25,30
YFM 400 Big Bear 2x4 00-04	78-351009	33,30	78-351009	33,30	78-04023	25,30	78-04023	25,30
YFM 400 Big Bear 4x4 00-06	78-351009	33,30	78-351009	33,30	78-04023	25,30	78-04023	25,30
YFM 400 Big Bear IRS 07-12	78-351009	33,30	78-351009	33,30	78-04023	25,30	78-04023	25,30
YFM 400 Kodiak 2x4 03-04	78-351009	33,30	78-351009	33,30	78-04023	25,30	78-04023	25,30
YFM 400 Kodiak 4x4 03-06	78-351009	33,30	78-351009	33,30	78-04023	25,30	78-04023	25,30
YFM 450 Kodiak 03-06	78-351009	33,30	78-351009	33,30	78-04023	25,30	78-04023	25,30
YFM 450 Grizzly IRS 07-14	78-351009	33,30	78-351009	33,30	78-04023	25,30	78-04023	25,30
YFM 450 Wolverine 06-10	78-351009	33,30	78-351009	33,30	78-04023	25,30	78-04023	25,30
YFZ 450 04-13					78-08801	26,50	78-04023	25,30
450 Rhino 06-08	78-351009	33,30	78-351009	33,30	78-04023	25,30	78-04023	25,30
YFM 550 Grizzly 09-12			78-351029	33,30			78-08800	26,50
YFM 550 Grizzly W/EPS 09-12			78-351029	33,30			78-08800	26,50
YFM 660 Grizzly 02-08	78-351034	43,40						
YFM 660 R Raptor 01-05	78-351029	29,00			78-08801	26,50		
660 Rhino 04-07	78-351009	33,30	78-351009	33,30	78-04023	25,30	78-04023	25,30
YFM 700 Grizzly 07-12			78-351029	33,30	78-08801	26,50	78-08800	26,50
YFM 700 Grizzly/EPS 13-14					78-08801	26,50	78-08801	26,50
YFM 700 Grizzly W/EPS 08-12			78-351029	33,30	78-08801	26,50	78-08800	26,50
YFM 700 R Raptor 06-12	78-351029	33,30			78-08801	26,50		
700 Rhino FI 4x4 08-13	78-351009	33,30	78-351009	33,30				



Vanteet ja renkaat



Talvituotteet



Vinsit



Laukut ja tuulisuojat



Sähköosat



Jousitus ja voimansiirto



Pakoputket ja suutinsarjat



Ohjauksen osat



Rungon osat ja peitteet



Jarrupalat ja rattaat



Moottori



Variaattorin osat



Maatalous-tarvikkeet



Kärryt ja reet

ATV





Vanteet ja renkaat



Talvituotteet



Vinssit



Laukut ja tuulisuojat



Sähköosat



Jousitus ja voimansiirto



Pakoputket ja suutinsarjat



Ohjauk



Rungon osat ja peitteet



Jarrupalat ja rattaat



Moottori



Variaattorin osat



Maatalous-tarvikkeet



Kärryt ja reet



ATV



ATV



ATV

120



BRONCO
ATV COMPONENTS

RAIDETANGON PÄÄT



78-08122



78-08123



78-08124 / 78-08133



78-08125 / 78-08125-1



78-08121



78-08126 / 78-08136



78-08127



78-08128



78-08129



78-08130



78-08131



78-08132



78-08557



78-08558



78-08559



78-08560



BRONCO
ATV COMPONENTS

BRONCO
ATV COMPONENTS

Arctic Cat	EPI				Bronco				
		ULOMPI	SISEMPI		ULOMPI	SISEMPI		SISEMPI	
150 Utility	2009-11				78-08125-1	24,20	78-08125	24,20	
250 DVX 2x4	2006-08	78-311023	30,80	78-315017	30,80	78-08125-1	24,20	78-08125	24,20
300 2x4	2010-12	78-311023	30,80	78-315017	30,80	78-08564	24,20	78-08136	24,20
300 2x4	1998-04	78-311023	30,80	78-315017	30,80	78-08564	24,20	78-08136	24,20
300 4x4	1998-05	78-311023	30,80	78-315017	30,80	78-08564	24,20	78-08136	24,20
300 DVX	2009-12	78-311023	30,80	78-315017	30,80	78-08125-1	24,20	78-08125	24,20
366 FIS w/AT	2008-11	78-311023	30,80	78-315017	30,80	78-08564	24,20	78-08136	24,20
375 2x4/4x4 w/AT	2002	78-311023	30,80	78-315017	30,80	78-08564	24,20	78-08136	24,20
400 2x4 w/MT	1998-04	78-311023	30,80	78-315017	30,80	78-08564	24,20	78-08136	24,20
400 4x4 00	1998-04	78-311023	30,80	78-315017	30,80	78-08564	24,20	78-08136	24,20
400 FIS 2x4 w/AT or w/MT	2003-11	78-311023	30,80	78-315017	30,80	78-08564	24,20	78-08136	24,20
400 FIS 4x4 w/AT or w/MT	2003-11	78-311023	30,80	78-315017	30,80	78-08564	24,20	78-08136	24,20
400 FIS 4x4	2002-04	78-311023	30,80	78-315017	30,80	78-08564	24,20	78-08136	24,20
400 DVX	2004-08	78-311023	30,80	78-315017	30,80	78-08125-1	24,20	78-08125	24,20
400 TBX 4x4	2004-06	78-311023	30,80	78-315017	30,80	78-08564	24,20	78-08136	24,20
400 TRV FIS 4x4	2009-13	78-311023	30,80	78-315017	30,80	78-08564	24,20	78-08136	24,20
400 TRV	2007	78-311023	30,80	78-315017	30,80	78-08564	24,20	78-08136	24,20
400 VP 4x4	2006	78-311023	30,80	78-315017	30,80	78-08564	24,20	78-08136	24,20
450 H1 4x4	2010-11	78-311023	30,80	78-315017	30,80	78-08564	24,20	78-08136	24,20
450i EFI	2012	78-311023	30,80	78-315017	30,80	78-08564	24,20	78-08136	24,20
450i TRV	2012	78-311023	30,80	78-315017	30,80	78-08564	24,20	78-08136	24,20
500 4x4 w/AT	2000-02	78-311023	30,80	78-315017	30,80	78-08564	24,20	78-08136	24,20
500 4x4 w/MT	2001	78-311023	30,80	78-315017	30,80	78-08564	24,20	78-08136	24,20
500 FIS 4x4 w/AT	2002-09	78-311023	30,80	78-315017	30,80	78-08564	24,20	78-08136	24,20
500 FIS 4x4 w/MT	2004-09	78-311023	30,80	78-315017	30,80	78-08564	24,20	78-08136	24,20
500 FIS TBX 4x4	2002-06	78-311023	30,80	78-315017	30,80	78-08564	24,20	78-08136	24,20
500 FIS TRV 4x4	2003-06	78-311023	30,80	78-315017	30,80	78-08564	24,20	78-08136	24,20
500 TBX 4x4 04	2004	78-311023	30,80	78-315017	30,80	78-08564	24,20	78-08136	24,20
500 TBX 4x4 w/AT	2002-03	78-311023	30,80	78-315017	30,80	78-08564	24,20	78-08136	24,20
500 TRV 4x4	2008	78-311023	30,80	78-315017	30,80	78-08564	24,20	78-08136	24,20
550 H1 EFI 4x4	2009-12	78-311023	30,80	78-315017	30,80	78-08564	24,20	78-08136	24,20
500 EFI 4x4	2013	78-311023	30,80	78-315017	30,80	78-08564	24,20	78-08136	24,20
550 TRV 4x4	2009-13	78-311023	30,80	78-315017	30,80	78-08564	24,20	78-08136	24,20
650 H1 4x4	2005-12	78-311023	30,80	78-315017	30,80	78-08564	24,20	78-08136	24,20
650 V2 4x4	2004-06	78-311023	30,80	78-315017	30,80	78-08564	24,20	78-08136	24,20
700 Diesel 4x4	2007-13	78-311023	30,80	78-315017	30,80	78-08564	24,20	78-08136	24,20
700 EFI 4x4	2007-12	78-311023	30,80	78-315017	30,80	78-08564	24,20	78-08136	24,20
700 H1 EFI 4x4	2008-11	78-311023	30,80	78-315017	30,80	78-08564	24,20	78-08136	24,20
1000 Mud Pro H2 4x4	201013	78-311023	30,80	78-315017	30,80	78-08564	24,20	78-08136	24,20
1000 Thunder Cat H2 4x4	2008-13	78-311023	30,80	78-315017	30,80	78-08564	24,20	78-08136	24,20
1000i GT	2012-13	78-311023	30,80	78-315017	30,80	78-08564	24,20	78-08136	24,20
1000 Wildcat	2013-	78-315039	30,80	78-315038	30,80				

RAIDETANGON PÄÄT JATKUU



CAN-AM		ULOMPI	HINTA	SISEMPI	HINTA	ULOMPI	HINTA	SISEMPI	HINTA
330 Outlander	2004-05	78-315015	30,80	78-311011	30,80	78-08122	24,20	78-08568	24,20
400 Outlander	2003-14	78-315015	30,80	78-311011	30,80	78-08122	24,20	78-08568	24,20
500 Outlander	2007-12	78-315015	30,80	78-311011	30,80	78-08122	24,20	78-08568	24,20
500 Outlander	2013-14	78-315036	30,80	78-315037	30,80				
500 Renegade	2008-12	78-315015	30,80	78-311011	30,80	78-08122	24,20	78-08568	24,20
500 Renegade	2013-14	78-315036	30,80	78-315037	30,80				
650 Outlander	2007-12	78-315015	30,80	78-311011	30,80	78-08122	24,20	78-08568	24,20
650 Outlander	2013-14	78-315036	30,80	78-315037	30,80				
800 Outlander	2006-12	78-315015	30,80	78-311011	30,80	78-08122	24,20	78-08568	24,20
800 Outlander	2013-14	78-315036	30,80	78-315037	30,80				
800 Renegade	2007-12	78-315015	30,80	78-311011	30,80	78-08122	24,20	78-08568	24,20
800 Renegade	2013-14	78-315036	30,80	78-315037	30,80				
1000 Outlander STD/XT	2012	78-315015	30,80	78-311011	30,80	78-08122	24,20	78-08568	24,20
1000 Outlander	2013-14	78-315036	30,80	78-315037	30,80				
1000 Renegade 1000 XXC	2012	78-315015	30,80	78-311011	30,80	78-08122	24,20	78-08568	24,20
1000 Renegade	2013-14	78-315036	30,80	78-315037	30,80				
HONDA		ULOMPI	HINTA	SISEMPI	HINTA	ULOMPI	HINTA	SISEMPI	HINTA
TRX 70	1986-87							78-08121	24,20
TRX 90	1993-14	78-311004	30,80	78-311001	30,80	78-08121	24,20	78-08562	24,20
TRX 90 EX	2007-09	78-311004	30,80	78-311001	30,80	78-08121	24,20	78-08562	24,20
TRX 125	1985-88	78-311004	30,80	78-311001	30,80				
TRX 200	1986-97	78-315015	30,80	78-315010	30,80	78-08121	24,20	78-08562	24,20
TRX 250 Fourtrax	1985-86	78-311004	30,80	78-311001	30,80	78-08121	24,20	78-08562	24,20
TRX 250 EX Sportrax	2001-14	78-315015	30,80	78-315010	30,80	78-08122	24,20	78-08123	24,20
TRX 250 R	1986-89	78-315013	30,80	78-315008	30,80	78-08124	24,20	78-08567	24,20
TRX 250 Recon	1997-14	78-315015	30,80	78-315010	30,80	78-08122	24,20	78-08123	24,20
TRX 250 X	1987-92	78-315013	30,80	78-315008	30,80	78-08124	24,20	78-08567	24,20
TRX 300 EX	1993-08	78-315013	30,80	78-315008	30,80	78-08124	24,20	78-08567	24,20
TRX 300 Fourtrax 4x4	1988-00	78-315015	30,80	78-315010	30,80	78-08122	24,20	78-08123	24,20
TRX 300 FW Fourtrax 4x4	1988-00	78-315015	30,80	78-315010	30,80	78-08122	24,20	78-08123	24,20
TRX 350 FE/FM Fourtrax Rancher	2000-06	78-315015	30,80	78-315010	30,80	78-08122	24,20	78-08123	24,20
TRX 350 TE/TM Fourtrax Rancher	2000-06	78-315015	30,80	78-315010	30,80	78-08122	24,20	78-08123	24,20
TRX 400 EX	1999-14	78-315013	30,80	78-315008	30,80	78-08124	24,20	78-08567	24,20
TRX 400 FA/FGA Fourtrax Rancher 4x4	2004-06	78-315015	30,80	78-315010	30,80	78-08122	24,20	78-08123	24,20
TRX 400 FW Fourtrax Foreman 4x4	2002-03	78-315015	30,80	78-315010	30,80	78-08122	24,20	78-08123	24,20
TRX 400 FW Fourtrax Foreman 4x4	1995-01	78-315015	30,80	78-315010	30,80	78-08122	24,20	78-08123	24,20
TRX 400 X	2012-14	78-315013	30,80	78-315008	30,80	78-08124	24,20	78-08567	24,20
TRX 420 FA/FPA	2009-14	78-315015	30,80	78-315010	30,80	78-08122	24,20	78-08123	24,20
TRX 420 FE/FM/TE/TM	2007-13	78-315015	30,80	78-315010	30,80	78-08122	24,20	78-08123	24,20
TRX 450 ER	2004-09	78-315013	30,80	78-315008	30,80	78-08124	24,20	78-08567	24,20
TRX 450 R	2006-13	78-315013	30,80	78-315008	30,80	78-08124	24,20	78-08567	24,20
TRX 450 FE/FM	2002-04	78-315015	30,80	78-315010	30,80	78-08122	24,20	78-08123	24,20
TRX 450 S/ES	1998-04	78-315015	30,80	78-315010	30,80	78-08122	24,20	78-08123	24,20
TRX 500 FA	2001-14	78-315015	30,80	78-315010	30,80	78-08122	24,20	78-08123	24,20
TRX 500 FE	2005-14	78-315015	30,80	78-315010	30,80	78-08122	24,20	78-08123	24,20
TRX 500 FM	2005-14	78-315015	30,80	78-315010	30,80	78-08122	24,20	78-08123	24,20
TRX 500 FGA	2001-09	78-315015	30,80	78-315010	30,80	78-08122	24,20	78-08123	24,20
TRX 500 FPA/FPE/FPM	2008-13	78-315015	30,80	78-315010	30,80	78-08122	24,20	78-08123	24,20
TRX 500 TM	2005-06	78-315015	30,80	78-315010	30,80	78-08122	24,20	78-08123	24,20
TRX 650 Rincon	2003-05	78-315015	30,80	78-315010	30,80	78-08122	24,20	78-08123	24,20
TRX 680 Rincon	2006-14	78-315015	30,80	78-315010	30,80	78-08122	24,20	78-08123	24,20
KAWASAKI		ULOMPI	HINTA	SISEMPI	HINTA	ULOMPI	HINTA	SISEMPI	HINTA
50	2003-06	78-311005	30,80	78-311003	30,80				
80	2003-06	78-315022	30,80	78-315017	30,80	78-08136	24,20	78-08126	24,20
110	1987-88	78-315022	30,80	78-315017	30,80	78-08136	24,20	78-08126	24,20
185 Bayou	1985-88	78-315022	30,80	78-315017	30,80	78-08136	24,20	78-08126	24,20
220 Bayou	1988-02	78-315022	30,80	78-315017	30,80	78-08136	24,20	78-08126	24,20
250 Bayou	2003-12	78-315022	30,80	78-315017	30,80	78-08136	24,20	78-08126	24,20
250 Mojave	1987-04	78-315022	30,80	78-315017	30,80	78-08136	24,20	78-08126	24,20
250 Tecate	1987-88	78-315022	30,80	78-315017	30,80	78-08136	24,20	78-08126	24,20
300 Bayou	1986-04	78-315022	30,80	78-315017	30,80	78-08136	24,20	78-08126	24,20
300 Brute Force	2013-14	78-315025	30,80	78-315021	30,80	78-08125	24,20	78-08125-1	24,20
300 Lakota	1995-03	78-315022	30,80	78-315017	30,80	78-08136	24,20	78-08126	24,20
300 Prairie	2001-02	78-315022	30,80	78-311018	30,80	78-08136	24,20	78-08126	24,20
300 Prairie	1999-00	78-315022	30,80	78-315017	30,80	78-08136	24,20	78-08126	24,20
360 Prairie	2003-12	78-315015	30,80	78-311011	30,80	78-08136	24,20	78-08568	24,20
400 Bayou	1993-99	78-315022	30,80	78-315017	30,80	78-08136	24,20	78-08126	24,20
400 KFX	2004-06	78-315025	30,80	78-315021	30,80	78-08125	24,20	78-08125-1	24,20
400 KFX	2003	78-315022	30,80	78-315017	30,80	78-08136	24,20	78-08126	24,20
400 Prairie	2001-02	78-315022	30,80	78-311018	30,80	78-08563	24,20	78-08126	24,20
400 Prairie	1997-00	78-315022	30,80	78-315017	30,80	78-08136	24,20	78-08126	24,20
450 KFX R	2008-14	78-311045	30,80	78-311046	30,80	78-08565	24,20	78-08566	24,20
650 Brute Force	2005-12	78-311023	30,80	78-311018	30,80	78-08563	24,20	78-08564	24,20
650i Brute Force	2006-12	78-315013	30,80	78-315008	30,80	78-08567	24,20	78-08124,20	24,20
650 Prairie	2002-03	78-311023	30,80	78-311018	30,80	78-08563	24,20	78-08564	24,20
700 Prairie	2004-06	78-311023	30,80	78-311018	30,80	78-08563	24,20	78-08564	24,20
750 Brute Force	2005-13	78-315013	30,80	78-315008	30,80	78-08567	24,20	78-08124,20	24,20



RAIDETANGON PÄÄT JATKUU



BRONCO
ATV EQUIPMENTS

BRONCO
ATV EQUIPMENTS

POLARIS		ULOMPI		SISEMPI	HINTA	ULOMPI		SISEMPI	HINTA
50 Predator 2x4	2004-07	78-311043	30,80	78-311044	30,80	78-08125	24,20	78-08125-1	24,20
50 Scrambler 2x4	2001-03	78-311043	30,80	78-311044	30,80	78-08125	24,20	78-08125-1	24,20
90 Predator 2x4	2003-06	78-311043	30,80	78-311044	30,80	78-08125	24,20	78-08125-1	24,20
90 Scrambler 2x4	2001-03	78-311043	30,80	78-311044	30,80	78-08125	24,20	78-08125-1	24,20
90 Sportsman 2x4	2001-09	78-311043	30,80	78-311044	30,80	78-08125	24,20	78-08125-1	24,20
90 Outlaw 2x4	2009-11	78-311043	30,80	78-311044	30,80	78-08125	24,20	78-08125-1	24,20
250 Big Boss 4x6	1989-92	78-310171	30,80	78-310172	30,80	78-08127	24,20		
250 Big Boss 6x6	1991-93	78-310171	30,80	78-312179	30,80	78-08127	24,20	78-08128	24,20
250 Trail Blazer 2x4	1997-06	78-311138	30,80	78-311139	30,80				
250 Trail Blazer 2x4	1996	78-310171	30,80	78-312179	30,80	78-08127	24,20	78-08128	24,20
250 Trail Blazer 2x4	1990-95	78-310171	30,80	78-310172	30,80	78-08127	24,20		
250 Trail Boss 2x4	1988-99	78-310171	30,80	78-310172	30,80	78-08127	24,20		
250 Trail Boss 2x4	1987	-		78-310172	30,80				
250 Trail Boss 4x4	1989-93	78-310171	30,80	78-312179	30,80	78-08127	24,20	78-08128	24,20
250 Trail Boss 4x4	1987-88	78-310171	30,80	78-310172	30,80	78-08127	24,20		
250 Xplorer 4x4	2000-02	78-311138	30,80	78-311139	30,80	78-08132	24,20	78-08131	24,20
300 2x4	1994-95	78-310171	30,80	78-310172	30,80	78-08127	24,20		
300 4x4	1994-95	78-310171	30,80	78-312179	30,80	78-08127	24,20	78-08128	24,20
300 Big Boss 6x6	1994	78-310171	30,80	78-312179	30,80	78-08127	24,20	78-08128	24,20
300 Xplorer 4x4	1998-99	78-311138	30,80	78-312179	30,80	78-08132	24,20	78-08128	24,20
300 Xplorer 4x4	1996-97	78-310171	30,80	78-312179	30,80	78-08127	24,20	78-08128	24,20
300 Xpress 2x4	1998-99	78-311138	30,80	78-311139	30,80	78-08132	24,20		
300 Xpress 2x4	1996-97	78-310171	30,80	78-312179	30,80	78-08127	24,20	78-08128	24,20
325 Magnum 2x4/4x4	2000-02	78-311138	30,80	78-311139	30,80	78-08132	24,20	78-08131	24,20
325 Trail Boss 2x4	2000-02	78-311138	30,80	78-311139	30,80	78-08132	24,20	78-08131	24,20
325 Xpedition 4x4	2000-02	78-311138	30,80	78-311139	30,80	78-08132	24,20	78-08131	24,20
330 ATP 4x4	2004-05	78-311138	30,80	78-311139	30,80	78-08132	24,20	78-08131	24,20
330 Magnum 2x4	2003-05	78-311138	30,80	78-311139	30,80	78-08132	24,20	78-08131	24,20
330 Magnum 4x4	2003-06	78-311138	30,80	78-311139	30,80	78-08132	24,20	78-08131	24,20
330 Trail Blazer 2x4	2008-13	78-311138	30,80	78-311139	30,80	78-08132	24,20	78-08131	24,20
330 Trail Boss 2x4	2007-12	78-311138	30,80	78-311139	30,80	78-08132	24,20	78-08131	24,20
330 Trail Boss	2003-12	78-311138	30,80	78-311139	30,80	78-08132	24,20	78-08131	24,20
335 Sportsman 4x4	1999-00	78-311138	30,80	78-311139	30,80	78-08132	24,20	78-08131	24,20
350 Big Boss 6x6	1993	78-310171	30,80	78-312179	30,80	78-08127	24,20	78-08128	24,20
350 Trail Boss 2x4	1990-93	78-310171	30,80	78-310172	30,80	78-08127	24,20		
350 Trail Boss 4x4	1990-93	78-310171	30,80	78-312179	30,80	78-08127	24,20	78-08128	24,20
400 2x4	1994-95	78-310171	30,80	78-310172	30,80	78-08127	24,20		
400 4x4	1994	78-310171	30,80	78-312179	30,80	78-08127	24,20	78-08128	24,20
400 Big Boss 6x6	1997	78-310171	30,80	78-311015	30,80	78-08127	24,20		
400 Big Boss 6x6	1995-96	78-310171	30,80	78-312179	30,80	78-08127	24,20	78-08128	24,20
400 Big Boss 6x6	1994	78-310171	30,80	78-312179	30,80	78-08127	24,20	78-08128	24,20
400 Hawkeye	2012-14	78-311138	30,80	78-311139	30,80	78-08132	24,20	78-08131	24,20
400 Ranger HO 4x4	2010-14	78-311138	30,80			78-08132	24,20		
400 Scrambler 2x4	2000-02	78-311138	30,80	78-311139	30,80	78-08132	24,20	78-08131	24,20
400 Scrambler 4x4	1997-02	78-311138	30,80	78-311139	30,80	78-08132	24,20	78-08131	24,20
400 Scrambler 4x4	1995-96	78-310171	30,80	78-312179	30,80	78-08127	24,20		
400 Sport 2x4	1997-99	78-311138	30,80	78-311139	30,80	78-08132	24,20	78-08131	24,20
400 Sport 2x4	1996	78-310171	30,80	78-312179	30,80	78-08127	24,20	78-08128	24,20
400 Sport 2x4	1994-95	78-310171	30,80	78-310172	30,80	78-08127	24,20		
400 Sportsman Ho	2009-14	78-315033	30,80	78-315034	30,80				
400 Sportsman 4x4	2001-05	78-311138	30,80	78-311139	30,80	78-08132	24,20	78-08131	24,20
400 Sportsman 4x4	1995-97	78-310171	30,80	78-312179	30,80	78-08127	24,20	78-08128	24,20
400 Sportsman 4x4	1993-94	78-310171	30,80	78-312179	30,80	78-08127	24,20	78-08128	24,20
400 Trail Blazer 2x4	2003	78-311138	30,80	78-311139	30,80	78-08132	24,20	78-08131	24,20
400 Xplorer 4x4	1998-02	78-311138	30,80	78-311139	30,80	78-08132	24,20	78-08131	24,20
400 Xplorer 4x4	1995-97	78-310171	30,80	78-312179	30,80	78-08127	24,20	78-08128	24,20
400 Xpress 2x4	1996-97	78-310171	30,80	78-312179	30,80	78-08127	24,20	78-08128	24,20
425 Magnum 2x4	1998	78-311138	30,80	78-311139	30,80	78-08132	24,20	78-08131	24,20
425 Magnum 2x4	1996-97	78-310171	30,80	78-312179	30,80	78-08127	24,20	78-08128	24,20
425 Magnum 2x4	1995	78-310171	30,80	78-310172	30,80	78-08127	24,20		
425 Magnum 4x4	1998	78-311138	30,80	78-311139	30,80	78-08132	24,20	78-08131	24,20
425 Magnum 4x4	1995-97	78-310171	30,80	78-312179	30,80	78-08127	24,20	78-08128	24,20
425 Magnum 6x6	1996-97	78-310171	30,80	78-311015	30,80	78-08127	24,20	78-08128	24,20
425 Xpedition 4x4	2000-02	78-311138	30,80	78-311139	30,80	78-08132	24,20	78-08131	24,20
450 Sportsman 4x4	2007	78-311138	30,80	78-311139	30,80	78-08132	24,20	78-08131	24,20
450 Sportsman 4x4	2006	78-311138	30,80	78-311139	30,80	78-08132	24,20	78-08131	24,20
500 ATP 4x4	2004-05	78-311138	30,80	78-311139	30,80	78-08132	24,20	78-08131	24,20
500 Big Boss 6x6	1998-99	78-311138	30,80	78-311139	30,80	78-08132	24,20	78-08131	24,20
500 Magnum RMK 4x4	2002	78-311138	30,80	78-311139	30,80	78-08132	24,20	78-08131	24,20
500 Magnum 4x4	1999-02	78-311138	30,80	78-311139	30,80	78-08132	24,20	78-08131	24,20
500 Predator 2x4	2003-06	78-311112	30,80	78-311113	30,80				
500 Ranger 2x4	2004-08	78-311138	30,80	-		78-08132	24,20		
500 Ranger 4x4	2004-07	78-311138	30,80	-		78-08132	24,20		
500 Ranger EFI 4x4	2006-12	78-311138	30,80	-		78-08132	24,20		
500 Ranger 6x6	2004-05	78-311138	30,80	-		78-08132	24,20		
500 Scrambler 2x4	2001-02	78-311138	30,80	78-311139	30,80	78-08132	24,20	78-08131	24,20
500 Scrambler 4x4	1997-12	78-311138	30,80	78-311139	30,80	78-08132	24,20	78-08131	24,20



ATV

RAIDETANGON PÄÄT JATKUU



BRONCO
ATV COMPANIES

BRONCO
ATV COMPANIES

POLARIS		ULOMPI		SISEMPI	HINTA	ULOMPI		SISEMPI	HINTA
500 Sportsman EFI 4x4	2006-09	78-311138	30,80	78-311139	30,80	78-08132	24,20	78-08131	24,20
500 Sportsman EFI Touring 4x4	2008-09	78-311138	30,80	78-311139	30,80	78-08132	24,20	78-08131	24,20
500 Sportsman EFI X2 4x4	2007-08	78-311138	30,80	78-311139	30,80	78-08132	24,20	78-08131	24,20
500 Sportsman HO 4x4	2008-09	78-311138	30,80	78-311139	30,80	78-08132	24,20	78-08131	24,20
500 Sportsman HO 4x4	2006	78-311138	30,80	78-311139	30,80	78-08132	24,20	78-08131	24,20
500 Sportsman HO 4x4	2001-12	78-311138	30,80	78-311139	30,80	78-08132	24,20	78-08131	24,20
500 Sportsman X2 4x4	2006	78-311138	30,80	78-311139	30,80	78-08132	24,20	78-08131	24,20
500 Sportsman 4x4	1998-00	78-311138	30,80	78-311139	30,80	78-08132	24,20	78-08131	24,20
500 Sportsman 4x4	1997	78-310171	30,80	78-311015	30,80	78-08127	24,20	78-08128	24,20
500 Sportsman 4x4	1996	78-310171	30,80	78-312179	30,80	78-08127	24,20	78-08128	24,20
500 Sportsman 6x6	2000-08	78-311138	30,80	78-311139	30,80	78-08132	24,20	78-08131	24,20
500 Xplorer 4x4	1997	78-310171	30,80	78-312179	30,80	78-08127	24,20	78-08128	24,20
550 Sportsman X2 4x4	2010-14	78-311018	30,80	78-312179	30,80	78-08126	24,20	78-08128	24,20
550 Sportsman XP 4x4 w/EPS	2010-14	78-311018	30,80	78-315022	30,80	78-08126	24,20	78-08563	24,20
570 RZR	2012-14	78-311018	30,80			78-08126	24,20		
570 Sportsman	2014-	78-311138	30,80	78-311139	30,80	78-08132	24,20	78-08131	24,20
600 Sportsman 4x4	2003-05	78-311138	30,80			78-08132	24,20		
700 MV7 4x4	2005	78-311138	30,80	78-311139	30,80	78-08132	24,20	78-08131	24,20
700 Ranger Crew 4x4	2008	78-311138	30,80	-		78-08132	24,20		
700 Ranger XP 4x4	2005-09	78-311138	30,80	-		78-08132	24,20		
700 Ranger EFI 6x6	2006-09	78-311138	30,80	-		78-08132	24,20		
700 Sportsman 4x4	2006-07	78-311138	30,80	78-311139	30,80	78-08132	24,20	78-08131	24,20
700 Sportsman 4x4	2002-05	78-311138	30,80	78-311139	30,80	78-08132	24,20	78-08131	24,20
700 Sportsman EFI 4x4	2004-07	78-311138	30,80	78-311139	30,80	78-08132	24,20	78-08131	24,20
700 Sportsman EFI X2 4x4	2008	78-311138	30,80	78-311139	30,80	78-08132	24,20	78-08131	24,20
800 Ranger XP 4x4	2010-14	78-311138	30,80			78-08132	24,20		
800 RZR 4x4	2008-14	78-311138	30,80			78-08132	24,20		
800 RZR 4 4x4	2010-14	78-311138	30,80			78-08132	24,20		
800 RZR S 4x4	2009-14	78-311138	30,80			78-08132	24,20		
800 Sportsman EFI 4x4	2009	78-311138	30,80	78-311139	30,80	78-08132	24,20	78-08131	24,20
800 Sportsman EFI HO 4x4	2008	78-311138	30,80	78-311139	30,80	78-08132	24,20	78-08131	24,20
800 Sportsman EFI 4x4	2005-12	78-311138	30,80	78-311139	30,80	78-08132	24,20	78-08131	24,20
800 Sportsman EFI Touring 4x4	2005-12	78-311138	30,80	78-311139	30,80	78-08132	24,20	78-08131	24,20
800 Sportsman EFI X2 4x4	2007	78-311138	30,80	78-311139	30,80	78-08132	24,20	78-08131	24,20
800 Sportsman EFI 6x6	2009	78-311138	30,80	78-311139	30,80	78-08132	24,20	78-08131	24,20
850 Sportsman XP 4x4	2010-14	78-311138	30,80	78-315022	30,80	78-08132	24,20	78-08563	24,20
900 Ranger Diesel 4x4	2011-14	78-311138	30,80	-		78-08132	24,20		
900 RZR XP 4x4	2011-14	78-311138	30,80	-		78-08132	24,20		
Diesel 4x4	1999-01	78-311138	30,80	78-311139	30,80	78-08132	24,20	78-08131	24,20
Ranger EV LSV 4x4	2011	78-311138	30,80	-		78-08132	24,20		
Ranger TM 2x4	2004-06	78-311138	30,80	-		78-08132	24,20		
SUZUKI		ULOMPI		SISEMPI	HINTA	ULOMPI		SISEMPI	HINTA
LT 50	1984-87	78-315022	30,80	78-315017	30,80	78-08126	24,20	78-08136	24,20
LT-A 50	2002-05	78-311005	30,80	78-311003	30,80	78-08121	24,20	78-08562	24,20
LT-Z 50	2006-08	78-311005	30,80	78-311003	30,80	78-08121	24,20	78-08562	24,20
LT 80	1987-06	78-315022	30,80	78-315017	30,80	78-08126	24,20	78-08136	24,20
LT-Z 90 QuadSport	2007-09	78-311005	30,80	78-311003	30,80	78-08121	24,20	78-08562	24,20
LT 125	1985-87	78-315022	30,80	78-315017	30,80	78-08126	24,20	78-08136	24,20
LT 125	1983-84	78-315022	30,80	78-315017	30,80	78-08126	24,20	78-08136	24,20
LT 160	2003-04	78-311005	30,80	78-311001	30,80	78-08121	24,20	78-08562	24,20
LT 160 E	1989-92	78-311005	30,80	78-311001	30,80	78-08121	24,20	78-08562	24,20
LT-F 160	1991-01	78-311005	30,80	78-311001	30,80	78-08121	24,20	78-08562	24,20
LT 185	1984-87	78-315022	30,80	78-315017	30,80	78-08126	24,20	78-08136	24,20
LT 230 E	1987-93	78-315022	30,80	78-315017	30,80	78-08126	24,20	78-08136	24,20
LT 230 GE	1985-86	78-315022	30,80	78-315017	30,80	78-08126	24,20	78-08136	24,20
LT 230 S	1985-88	78-315022	30,80	78-315017	30,80	78-08126	24,20	78-08136	24,20
LT-F 230	1986-87	78-315022	30,80	78-315017	30,80	78-08126	24,20	78-08136	24,20
LT 250 EF	1985-86	78-315022	30,80	78-315017	30,80	78-08126	24,20	78-08136	24,20
LT 250 R	1985-92	78-315022	30,80	78-315017	30,80	78-08126	24,20	78-08136	24,20
LT 250 S	1989-90	78-315022	30,80	78-315017	30,80	78-08126	24,20	78-08136	24,20
LT 250 4WD	1987-98	78-315026	30,80	78-315017	30,80	78-08557	24,20	78-08136	24,20
LT-F 250	1988-01	78-315022	30,80	78-315017	30,80	78-08126	24,20	78-08136	24,20
LT-F 250 Ozark	2004-13	78-315025	30,80	78-315021	30,80	78-08125-1	24,20	78-08125	24,20
LT-F 250 Ozark	2003	78-315022	30,80	78-315017	30,80	78-08126	24,20	78-08136	24,20
LT-F 250 Ozark	2002	78-315022	30,80	78-315017	30,80	78-08126	24,20	78-08136	24,20
LT-F 250F (except Ozark)	1999-02	78-315026	30,80	78-315017	30,80	78-08557	24,20	78-08136	24,20
LT-F 250 4WD	1997-98	78-315026	30,80	78-315017	30,80	78-08557	24,20	78-08136	24,20
LT-Z 250	2004-09	78-315025	30,80	78-315021	30,80	78-08125-1	24,20	78-08125	24,20
LT 300E	1987-89	78-315022	30,80	78-315017	30,80	78-08126	24,20	78-08136	24,20
LT-F 300 4WDX King Quad	1991-98	78-315026	30,80	78-315017	30,80	78-08557	24,20	78-08136	24,20
LT-F 300F King Quad	1999-02	78-315026	30,80	78-315017	30,80	78-08557	24,20	78-08136	24,20
LT-A 400 Eiger 2WD	2002-04	78-315022	30,80	78-315017	30,80	78-08126	24,20	78-08136	24,20
LT-A 400F Eiger 4WD	2005-07	78-315025	30,80	78-315021	30,80	78-08125-1	24,20	78-08125	24,20
LT-A 400F Eiger 4WD	2002-04	78-315022	30,80	78-315017	30,80	78-08126	24,20	78-08136	24,20
LT-F 400 Eiger 2WD	2007	78-315022	30,80	78-315017	30,80	78-08126	24,20	78-08136	24,20
LT-F 400 Eiger 2WD	2003-04	78-315022	30,80	78-315017	30,80	78-08126	24,20	78-08136	24,20
LT-F 400F Eiger 4WD	2005-07	78-315025	30,80	78-315021	30,80	78-08125-1	24,20	78-08125	24,20



Vanteet ja renkaat



Talvituotteet



Vinsit



Laukut ja tuulisuojat



Sähköosat



Jousitus ja voimansiirto



Pakoputket ja suutinsarjat



Ohjaus



Rungon osat ja peitteet



Jarrupalat ja rattaat



Moottori



Variaattorin osat



Maatalous-tarvikkeet



Kärryt ja reet

ATV





RAIDETANGON PÄÄT JATKUU



	SUZUKI	ULOMPI	SISEMPI	HINTA	ULOMPI	SISEMPI	HINTA	ULOMPI	SISEMPI	HINTA
	LT-F 400F Eiger 4WD	2002-04	78-315022	30,80	78-315017	30,80	78-08126	24,20	78-08136	24,20
	LT-A 400 King Quad Auto 2WD	2008-09	78-315025	30,80	78-315021	30,80	78-08125-1	24,20	78-08125	24,20
	LT-F 400 King Quad STD 2WD	2008-09	78-315025	30,80	78-315021	30,80	78-08125-1	24,20	78-08125	24,20
	LT-A 400F King Quad Auto 4WD	2008-13	78-315025	30,80	78-315021	30,80	78-08125-1	24,20	78-08125	24,20
	LT-F 400 King Quad STD 4WD	2008-13	78-315025	30,80	78-315021	30,80	78-08125-1	24,20	78-08125	24,20
	LT-Z 400	2004-08	78-315025	30,80	78-315021	30,80	78-08125-1	24,20	78-08125	24,20
	LT-Z 400	2003	78-315022	30,80	78-315017	30,80	78-08126	24,20	78-08136	24,20
	LTA 450 X King Quad	2007-10	78-315029	30,80	78-315030	30,80	78-08575	24,20	78-08575-1	24,20
	LT-A 500F Vinson	2004-07	78-315025	30,80	78-315021	30,80	78-08125-1	24,20	78-08125	24,20
	LT-A 500F Vinson	2003	78-315022	30,80	78-315017	30,80	78-08126	24,20	78-08136	24,20
	LT-A 500F Vinson	2002	78-315022	30,80	78-315017	30,80	78-08126	24,20	78-08136	24,20
	LT-F 500F Vinson	2004-07	78-315025	30,80	78-315021	30,80	78-08125-1	24,20	78-08125	24,20
	LT-F 500F Vinson	2003	78-315022	30,80	78-315017	30,80	78-08126	24,20	78-08136	24,20
	LT-A 700X King Quad	2005-07	78-315029	30,80	78-315030	30,80	78-08575	24,20	78-08575-1	24,20
	LT-V 700F Twin Peaks	2004-06			78-311018	30,80			78-08563	24,20
	LTA 750 X King Quad	2008-10	78-315029	30,80	78-315030	30,80	78-08575	24,20	78-08575-1	24,20
	LTA 750 X King Quad	2011-13	78-311045	30,80	78-311046	30,80	78-08565	24,20	78-08566	24,20
	YAMAHA		ULOMPI	HINTA	SISEMPI	HINTA	ULOMPI	HINTA	SISEMPI	HINTA
	50 Raptor	2004-08	78-311016	30,80	78-311023	30,80			78-08564	24,20
	80 YFM	1985-88	78-311016	30,80	78-311023	30,80			78-08564	24,20
	80 Badger	1992-01	78-311016	30,80	78-311023	30,80			78-08564	24,20
	80 Grizzly	2005-08	78-311016	30,80	78-311023	30,80			78-08564	24,20
	80 Raptor	2002-08	78-311016	30,80	78-311023	30,80			78-08564	24,20
	90 Raptor	2009-11	78-310171	30,80	78-310172	30,80				
	100 YFM	1987-91	78-311016	30,80	78-311023	30,80			78-08564	24,20
	125 Grizzly	2004-13	78-315021	30,80	78-315025	30,80	78-08125-1	24,20	78-08125	24,20
	125 Raptor	2011-13	78-315021	30,80	78-315025	30,80	78-08125-1	24,20	78-08125	24,20
	125 YFA1	1994-04	78-315021	30,80	78-315025	30,80	78-08125-1	24,20	78-08125	24,20
	200 Blaster	1988-06	78-315021	30,80	78-315025	30,80	78-08125-1	24,20	78-08125	24,20
	200 Moto-4	1986-89	78-315021	30,80	78-315025	30,80	78-08125-1	24,20	78-08125	24,20
	225 Moto-4	1986-88	78-315021	30,80	78-315025	30,80	78-08125-1	24,20	78-08125	24,20
	250 Beartracker	1999-04	78-311009	30,80	78-311014	30,80	78-08559	24,20	78-08558	24,20
	250 Big Bear	2007-09	78-311009	30,80	78-311014	30,80	78-08559	24,20	78-08558	24,20
	250 Bruin	2005-06	78-311009	30,80	78-311014	30,80	78-08559	24,20	78-08558	24,20
	250 Moto-4	1989-91	78-315021	30,80	78-315025	30,80	78-08125-1	24,20	78-08125	24,20
	250 Raptor	2008-13	78-315021	30,80	78-315025	30,80	78-08125-1	24,20	78-08125	24,20
	250 Timberwolf	1992-00	78-315021	30,80	78-315025	30,80	78-08125-1	24,20	78-08125	24,20
	350 Banshee	1987-06	78-315021	30,80	78-315025	30,80	78-08125-1	24,20	78-08125	24,20
	350 Big Bear	1987-99	78-315021	30,80	78-315025	30,80	78-08125-1	24,20	78-08125	24,20
	350 Bruin 2x4/4x4	2004-06	78-311009	30,80	78-311014	30,80	78-08559	24,20	78-08558	24,20
	350 Grizzly 2x4	2007-12	78-311009	30,80	78-311014	30,80	78-08559	24,20	78-08558	24,20
	350 Grizzly 4x4	2007-12	78-311009	30,80	78-311014	30,80	78-08559	24,20	78-08558	24,20
	350 Grizzly IRS 4x4	2007-12	78-311009	30,80	78-311014	30,80	78-08559	24,20	78-08558	24,20
	350 Grizzly 4x4	2013-14	78-315021	30,80	78-315025	30,80	78-08125-1	24,20	78-08125	24,20
	350 Moto-4	1987-95	78-315021	30,80	78-315025	30,80	78-08125-1	24,20	78-08125	24,20
	350 Raptor	2004-12	78-315021	30,80	78-315025	30,80	78-08125-1	24,20	78-08125	24,20
	350 Warrior	1987-04	78-315021	30,80	78-315025	30,80	78-08125-1	24,20	78-08125	24,20
	350 Wolverine	2006-09	78-311009	30,80	78-311014	30,80	78-08559	24,20	78-08558	24,20
	350 Wolverine	1995-05	78-315021	30,80	78-315025	30,80	78-08125-1	24,20	78-08125	24,20
	400 Big Bear 2x4	2000-04	78-311009	30,80	78-311014	30,80	78-08559	24,20	78-08558	24,20
	400 Big Bear 4x4	2000-06	78-311009	30,80	78-311014	30,80	78-08559	24,20	78-08558	24,20
	400 Big Bear IRS	2007-13	78-311009	30,80	78-311014	30,80	78-08559	24,20	78-08558	24,20
	400 Grizzly IRS	2007-11	78-311009	30,80	78-311014	30,80	78-08559	24,20	78-08558	24,20
	400 Kodiak 2x4	2003-04	78-311009	30,80	78-311014	30,80	78-08559	24,20	78-08558	24,20
	400 Kodiak 2x4	2000-01	78-315021	30,80	78-315025	30,80	78-08125-1	24,20	78-08125	24,20
	400 Kodiak 4x4	2005-06	78-311049	30,80	78-311014	30,80	78-08560	24,20	78-08558	24,20
	400 Kodiak 4x4	2003-04	78-311009	30,80	78-311014	30,80	78-08559	24,20	78-08558	24,20
	400 Kodiak 4x4	1993-02	78-315021	30,80	78-315025	30,80	78-08125-1	24,20	78-08125	24,20
	450 Grizzly IRS	2005-12	78-311049	30,80	78-311014	30,80	78-08560	24,20	78-08558	24,20
	450 Grizzly IRS/EPS	2013-14	78-315021	30,80	78-315025	30,80	78-08125-1	24,20	78-08125	24,20
	450 Kodiak	2005-06	78-311049	30,80	78-311014	30,80	78-08560	24,20	78-08558	24,20
	450 Kodiak	2003-04	78-311009	30,80	78-311014	30,80	78-08559	24,20	78-08558	24,20
	450 Wolverine	2006-10	78-311009	30,80	78-311014	30,80	78-08559	24,20	78-08558	24,20
	450 YFZ	2004-05	78-315021	30,80	78-315025	30,80	78-08125-1	24,20	78-08125	24,20
	450 YFZ R	2006-14	78-311046	30,80	78-311045	30,80	78-08566	24,20	78-08565	24,20
	450 YFZ X	2010-12	78-311046	30,80	78-311045	30,80	78-08566	24,20	78-08565	24,20
	550 Grizzly	2009-12	78-315021	30,80	78-315025	30,80	78-08125-1	24,20	78-08125	24,20
	550 Grizzly w/EPS	2009-14	78-315021	30,80	78-315025	30,80	78-08125-1	24,20	78-08125	24,20
	600 Grizzly	1998-01	78-315021	30,80	78-315025	30,80	78-08125-1	24,20	78-08125	24,20
	660 Grizzly	2002-08	78-315021	30,80	78-315025	30,80	78-08125-1	24,20	78-08125	24,20
	660 Raptor	2001-05	78-315021	30,80	78-315025	30,80	78-08125-1	24,20	78-08125	24,20
	700 Grizzly	2007-14	78-315021	30,80	78-315025	30,80	78-08125-1	24,20	78-08125	24,20
	700 Grizzly w/EPS	2008-14	78-315021	30,80	78-315025	30,80	78-08125-1	24,20	78-08125	24,20
	700 Raptor	2006-14	78-311046	30,80	78-311045	30,80	78-08566	24,20	78-08565	24,20



ETUVARREN PUSLASARJA/LAAKERISARJA



78-04120



78-04122



78-04123



78-04131



78-04132



78-04133



78-04340

uutuus!



78-04348

uutuus!

ARCTIC CAT					
Malli		Ylempi		Alempi	
250 2x4	1999-05	78-04128	39,70	78-04128	39,70
250 4x4	2001-05	78-04128	39,70	78-04128	39,70
300 2x4	1998-04	78-04128	39,70	78-04128	39,70
300 4x4	1998-05	78-04128	39,70	78-04128	39,70
375 2x4 / 4x4 w/AT	2002	78-04503	39,70	78-04128	39,70
400 2x4	1998-01	78-04128	39,70	78-04128	39,70
400 2x4 FIS w/AT	2003-04	78-04503	39,70	78-04128	39,70
400 2x4 FIS w/MT	2003-04	78-04503	39,70	78-04128	39,70
400 4x4	1998-00	78-04128	39,70	78-04128	39,70
400 4x4 w/AT	2003-04	78-04503	39,70	78-04128	39,70
400 4x4 w/MT	2002-04	78-04503	39,70	78-04128	39,70
400 4x4 w/MT	2001			78-04128	39,70
400 DVX	2004-08	78-04120	39,90	78-4120-1	39,70
400 FIS 4x4	2002			78-04128	39,70
400 FIS 4x4 w/AT	2004-08	78-04503	39,70	78-04502	39,70
400 FIS 4x4 w/AT	2003	78-04503	39,70	78-04128	39,70
400 FIS 4x4 w/MT	2004-08	78-04503	39,70	78-04502	39,70
400 FIS 4x4 w/MT	2002-03	78-04503	39,70	78-04128	39,70
400 TBX 4x4	2005-06	78-04503	39,70	78-04502	39,70
400 TBX 4x4	2004	78-04503	39,70	78-04128	39,70
400 TBX FIS 4x4	2005-06	78-04503	39,70	78-04502	39,70
400 TRV 4x4	2007	78-04503	39,70	78-04502	39,70
400 TRV FIS 4x4	2009-13	78-04503	39,70	78-04502	39,70
400 VP 4x4	2006	78-04503	39,70	78-04128	39,70
450i EFI 4x4	2012	78-04503	39,70	78-04502	39,70
450 H1 4x4	2010-11	78-04503	39,70	78-04502	39,70
450i GT 4x4	2012	78-04503	39,70	78-04502	39,70
450i TRV 4x4	2012	78-04503	39,70	78-04502	39,70
454 2x4	1997-98	78-04128	39,70	78-04128	39,70
454 4x4	1996-98	78-04128	39,70	78-04128	39,70
500 4x4	1998-99	78-04128	39,70	78-04128	39,70
500 4x4 w/AT	2002	78-04503	39,70	78-04128	39,70
500 4x4 w/AT	2000-01	78-04128	39,70	78-04128	39,70
500 4x4 w/MT	2000-01	78-04128	39,70	78-04128	39,70
500 EFI 4x4	2013	78-04503	39,70	78-04502	39,70
500 FIS 4x4 w/AT	2004-09	78-04503	39,70	78-04502	39,70
500 FIS 4x4 w/AT	2002-03	78-04503	39,70	78-04128	39,70
500 FIS 4x4 w/MT	2004-09	78-04503	39,70	78-04502	39,70
500 FIS 4x4 w/MT	2002	78-04503	39,70	78-04128	39,70
500 FIS TBX 4x4	2002-04	78-04503	39,70	78-04128	39,70
500 TRV 4x4	2013	78-04503	39,70	78-04502	39,70
500 TRV FIS 4x4	2005-08	78-04503	39,70	78-04502	39,70
500 FIS TRV 4x4	2003-04	78-04503	39,70	78-04128	39,70
500 XT EFI 4x4	2013	78-04503	39,70	78-04502	39,70
550 GT EFI 4x4	2012	78-04503	39,70	78-04502	39,70
550 H1 FIS 4x4	2012	78-04503	39,70	78-04502	39,70
550 TRV 4x4	2013	78-04503	39,70	78-04502	39,70
550 TRV 4x4 w/AT	2009-11	78-04503	39,70	78-04502	39,70
550i TRV GT EFI 4x4	2013	78-04503	39,70	78-04502	39,70
550 TRV XT 4x4	2013	78-04503	39,70	78-04502	39,70
550 Prowler XT 4x4	2009-13	78-04503	39,70	78-04502	39,70

ARCTIC CAT					
Malli		Ylempi		Alempi	
550 XT EFI 4x4	2013	78-04503	39,70	78-04502	39,70
650i 4x4	2012	78-04503	39,70	78-04502	39,70
650 H1 4x4	2005-11	78-04503	39,70	78-04502	39,70
650 H1 Mud Pro 4x4	2010-11	78-04503	39,70	78-04502	39,70
650 Prowler XT 4x4	2006-09	78-04503	39,70	78-04502	39,70
650 V2 4x4	2004-06	78-04503	39,70	78-04502	39,70
700i Diesel 4x4	2012-13	78-04503	39,70	78-04502	39,70
700 Diesel 4x4	2008-11	78-04503	39,70	78-04502	39,70
700 EFI 4x4	2007-12	78-04503	39,70	78-04502	39,70
700 GT EFI 4x4	2012	78-04503	39,70	78-04502	39,70
700 H1 EFI 4x4	2008-11	78-04503	39,70	78-04502	39,70
700i Mud Pro 4x4	2012-13	78-04503	39,70	78-04502	39,70
700 H1 Mud Pro 4x4	2009-11	78-04503	39,70	78-04502	39,70
700 H1 TRV 4x4	2008-11	78-04503	39,70	78-04502	39,70
700 LTD EFI 4x4	2013	78-04503	39,70	78-04502	39,70
700 Prowler HDX 4x4	2012	78-04503	39,70	78-04502	39,70
700 Prowler XTX 4x4	2008-12	78-04503	39,70	78-04502	39,70
700 Prowler XTX EFI 4x4	2008-12	78-04503	39,70	78-04502	39,70
700i TRV Cruiser EFI 4x4	2012	78-04503	39,70	78-04502	39,70
700i TRV GT EFI 4x4	2012	78-04503	39,70	78-04502	39,70
700 XT 4x4	2013	78-04503	39,70	78-04502	39,70
1000 Cruiser 4x4	2012	78-04503	39,70	78-04502	39,70
1000i GT 4x4	2012	78-04503	39,70	78-04502	39,70
1000 Mud Pro 4x4	2012-13	78-04503	39,70	78-04502	39,70
1000 Mud Pro H2 4x4	2010-11	78-04503	39,70	78-04502	39,70
1000 Prowler XTX 4x4	2013	78-04502	39,70	78-04502	39,70
1000 Prowler XTX 4x4	2009-12	78-04503	39,70	78-04502	39,70
1000 Prowler XTX EFI 4x4	2011-12	78-04503	39,70	78-04502	39,70
1000 Thunder Cat H2 4x4	2009-11	78-04503	39,70	78-04502	39,70
1000 Thunder Cat 4x4	2008	78-04503	39,70	78-04502	39,70
1000 TRV GT 4x4	2012	78-04503	39,70	78-04502	39,70
1000 TRV LTD 4x4	2013	78-04503	39,70	78-04502	39,70
1000 XT 4x4	2013	78-04503	39,70	78-04502	39,70

Can-Am					
Malli		Ylempi		Alempi	
Outlander 330	2004-05			78-04348	19,90
Outlander 400	2003-14			78-04348	19,90
DS450EFIMXC	2009-14	78-04348	19,90	78-04348	19,90
DS450EFIXXC	2009-14	78-04348	19,90	78-04348	19,90
DS 450 STD/X	2008-12	78-04348	19,90	78-04348	19,90
Outlander 500	2007-12			78-04348	19,90
Outlander 500 Power Steering	2010-12			78-04348	19,90
Quest 500	2002-03	78-04348	19,90	78-04348	19,90
Renegade 500	2008-14	78-04348	19,90	78-04348	19,90
Renegade500PowerSteering	2012	78-04348	19,90	78-04348	19,90
Traxter 500	2001-05	78-04348	19,90	78-04348	19,90
Outlander 650	2007-14	78-04348	19,90	78-04348	19,90
Outlander 650 Power Steering	2010-14	78-04348	19,90	78-04348	19,90
Quest 650	2002-04			78-04348	19,90



Vanteet ja renkaat



Talvituotteet



Vinsit



Laukut ja tuulisuojat



Sähköosat



Jousitus ja voimansiirto



Pakoputket ja suutinsarjat



Ohjaus



Rungon osat ja peitteet



Jarrupalat ja rattaat



Moottori



Variaattorin osat



Maatalous-tarvikkeet



Kärryt ja reet



ATV



ATV



ATV



ATV

125



ETUVARREN PUSLASARJA/LAAKERISARJA JATKUU



Vanteet ja renkaat



Talvituetteet



Vinssit



Laukut ja tuulisuojat



Sähköosot



Jousitus ja voimansiirto



Pakoputket ja suutinsarjat



Ohjaukset



Rungon osat ja peitteet



Jarrupalat ja rattaat



Moottori



Variaattorin osat



Maatalous-tarvikkeet



Kärryt ja reet



ATV

Can-Am					
Malli		Ylempi		Alempi	
Traxter650	2004-05	78-04348	19,90	78-04348	19,90
Commander 800	2011-13			78-04348	19,90
Outlander 800	2006-14	78-04348	19,90	78-04348	19,90
Outlander 800 Power Steering	2010-14	78-04348	19,90	78-04348	19,90
OutlanderSTDXT800	2012	78-04348	19,90	78-04348	19,90
Renegade 800	2007-13	78-04348	19,90	78-04348	19,90
Renegade 800 Power Steering	2010-13	78-04348	19,90	78-04348	19,90
Renegade800XXC	2012	78-04348	19,90	78-04348	19,90
Commander 1000	2011-13			78-04348	19,90
Outlander STD/XT 1000	2012-14	78-04348	19,90	78-04348	19,90
Renegade1000XXC	2012-14	78-04348	19,90	78-04348	19,90

Honda					
Malli		Ylempi		Alempi	
TRX90	1993-14			78-04134	36,20
TRX200/D	1990-97	78-04134	36,20	78-04134	36,20
TRX250 Recon	1997-14	78-04134	36,20	78-04134	36,20
TRX250R	1987-88	78-04122	49,40	78-04122	49,40
TRX250R	1991-92	78-04122	49,40	78-04122	49,40
TRX250EX	2001-11	78-04134	36,20	78-04134	36,20
TRX300 Fourtrax	1988-00	78-04134	36,20	78-04134	36,20
TRX300FW 4X4	1988-00	78-04134	36,20	78-04134	36,20
TRX300EX	1993-08	78-04122	49,40	78-04122	49,40
TRX350FE/FM/TE/TM	2000-06	78-04134	36,20	78-04134	36,20
TRX400EX	1999-07	78-04122	49,40	78-04122	49,40
TRX400FA/FGA	2004-06	78-04134	36,20	78-04134	36,20
TRX400FM	2002	78-04134	36,20	78-04134	36,20
TRX400FW	1995-03	78-04134	36,20	78-04134	36,20
TRX450R	2004-11	78-04122	49,40	78-04122	49,40
TRX450ER	2006-14	78-04122	49,40	78-04122	49,40
TRX420FE/FM/TE/TM	2007-14	78-04123	29,20	78-04134	36,20
TRX450ES	1998-01	78-04134	36,20	78-04134	36,20
TRX450FE/FM	2002-04	78-04134	36,20	78-04134	36,20
TRX450S	1998-01	78-04134	36,20	78-04134	36,20
TRX500FA	2001-14	78-04123	29,20	78-04134	36,20
TRX500FE	2005-14	78-04123	29,20	78-04134	36,20
TRX500FGA	2004-14	78-04123	29,20	78-04134	36,20
TRX500FPE/FPM	2008-13	78-04123	29,20	78-04134	36,20
TRX500TM	2005-06	78-04123	29,20	78-04134	36,20
TRX650 Rincon	2003-05	78-04124	29,20	78-04134	36,20
TRX680 Rincon	2006-14	78-04124	29,20	78-04134	36,20

Kawasaki					
Malli		Ylempi		Alempi	
KSF250 Mojave	1987-04	78-04125	44,00	78-04125	44,00
KXF250 Tecate	1987-	78-04125	44,00	78-04125	44,00
KEF300 Lakota	1995-03	78-04125	44,00	78-04125	44,00
KFX400	2003-06	78-04120	49,40	78-04120-1	42,30
KFX450R	2008-14	78-04127	42,30		
KVF650i Brute Force	2006-13	78-04135	42,30	78-04127	42,30
KVF650 Brute Force	2005-07			78-04126	54,40
KVF650 Prairie	2002-03			78-04126	54,40
LTV-700F	2004-06			78-04126	54,40
KVF700 Prairie	2004-06	78-04127	42,30	78-04126	54,40
KFX700 V-Force	2004-08	78-04127	42,30	78-04127	42,30
KVF750 Brute Force	2005-13	78-04135	42,30	78-04127	42,30
Suzuki					
Malli		Ylempi		Alempi	
LT-Z 250	2004-08	78-04128	39,70	78-04128	39,70
LT-4WD	1987-98	78-04128	39,70	78-04128	39,70
LT-F250	1988-01	78-04128	39,70	78-04128	39,70
LT-F 250 Ozark	2002-12	78-04128	39,70	78-04128	39,70
LT-F4WD	1997-99	78-04128	39,70	78-04128	39,70
LT-F4WDX King Quad	1991-98	78-04128	39,70	78-04128	39,70
LT-F300F King Quad	1999-02	78-04128	39,70	78-04128	39,70

Suzuki					
Malli		Ylempi		Alempi	
LT-Z400	2003-12	78-04120	39,70	78-04120-1	39,70
LT-A400 Eiger 2X4	2002-07	78-04128	39,70	78-04128	39,70
LT-A400F Eiger 4X4	2002-07	78-04128	39,70	78-04128	39,70
LT-F400 Eiger	2003-07	78-04128	39,70	78-04128	39,70
LT-F400F Eiger	2002-07	78-04128	39,70	78-04128	39,70
LTA-450X	2007-09	78-04128	39,70		
LT-A500F	2000-01	78-04128	39,70	78-04128	39,70
LT-A500F Vinson	2002-07	78-04128	39,70	78-04128	39,70
LT-F500F Quad Runner	1998-02	78-04128	39,70	78-04128	39,70
LT-F500F Vinson	2004-07	78-04128	39,70	78-04128	39,70
LTA-700 X	2005-07			78-04128	39,70
LTV-700F	2004-06			78-04126	54,90
LTA-750X	2008-11	78-04128	39,70		

Yamaha					
Malli		Ylempi		Alempi	
660 RHINO	2004-07	78-04340	29,90	78-04340	29,90
700 RHINO FI	2008-12	78-04340	29,90	78-04340	29,90
Yamaha 450RHINO	2006-09	78-04340	29,90	78-04340	29,90
YFA1 Breeze 80cc	1991-04			78-04131	32,00
YFB250 Timberwolf	1992-98	78-04340	29,90	78-04340	29,90
YFB250FW Timberwolf	1994-00	78-04340	29,90	78-04340	29,90
YFM 350 GRIZZLY	2007-	78-04138	42,30	78-04138	42,30
YFM 400 BIG BEAR	2007-	78-04138	42,30	78-04138	42,30
YFM 450 KODIAK	2005-06	78-04138	42,30	78-04138	42,30
YFM 550 GRIZZLY	2009-	78-04138	42,30	78-04138	42,30
YFM 700 GRIZZLY	2007-	78-04138	42,30	78-04138	42,30
YFM125 Grizzly	2004-07			78-04131	32,00
YFM250 Beartracker	1999-04	78-04340	29,90	78-04340	29,90
YFM250 Big Bear	2007-09	78-04340	29,90	78-04340	29,90
YFM250 Raptor	2008-11	78-04132	32,00	78-04131	32,00
YFM250B Bruin	2005-06	78-04340	29,90	78-04340	29,90
YFM350 Grizzly IRS	2007-11	78-04340	29,90	78-04340	29,90
YFM350 Raptor	2004-11	78-04131	32,00	78-04131	32,00
YFM350 Warrior	1987-04	78-04131	32,00	78-04131	32,00
YFM350A Bruin 2WD	2004	78-04340	29,90	78-04340	29,90
YFM350BA Bruin 2WD	2005-06	78-04340	29,90	78-04340	29,90
YFM350FA Bruin 4WD	2004-06	78-04340	29,90	78-04340	29,90
YFM350FGW Grizzly 4WD	2007-12	78-04340	29,90	78-04340	29,90
YFM350FW Big Bear	1987-99	78-04340	29,90	78-04340	29,90
YFM350GW Grizzly 2WD	2007-11	78-04340	29,90	78-04340	29,90
YFM350U Big Bear	1996-99	78-04340	29,90	78-04340	29,90
YFM35FX Wolverine	1995-05	78-04340	29,90	78-04340	29,90
YFM35X Wolverine	2006-09	78-04340	29,90	78-04340	29,90
YFM400 Big Bear 2WD	2000-04	78-04340	29,90	78-04340	29,90
YFM400 Big Bear 4WD	2000-06	78-04340	29,90	78-04340	29,90
YFM400 Big Bear IRS	2007-12	78-04340	29,90	78-04340	29,90
YFM400 Grizzly IRS	2007-08	78-04340	29,90	78-04340	29,90
YFM400 Kodiak 2WD	2000-04	78-04340	29,90	78-04340	29,90
YFM400 Kodiak 4WD	1993-06	78-04340	29,90	78-04340	29,90
YFM450 Grizzly IRS	2007-14	78-04340	29,90	78-04340	29,90
YFM450 Kodiak	2003-06	78-04340	29,90	78-04340	29,90
YFM45FX Wolverine 450 4X4	2006-10	78-04340	29,90	78-04340	29,90
YFM550 Grizzly	2009-14	78-04340	29,90	78-04340	29,90
YFM550 Grizzly EPS	2009-14	78-04340	29,90	78-04340	29,90
YFM600 Grizzly	1998-02	78-04340	29,90	78-04340	29,90
YFM660 Grizzly	2002-08	78-04340	29,90	78-04340	29,90
YFM660R Raptor	2001-05	78-04133	29,20	78-04131	32,00
YFM700 Grizzly	2007-14	78-04340	29,90	78-04340	29,90
YFM700 Grizzly EPS	2008-14	78-04340	29,90	78-04340	29,90
YFM700R Raptor	2006-09	78-04132	29,20	78-04131	32,00
YFM700 Viking	2014-	78-04340	29,90	78-04340	29,90
YFS200 Blaster	1988-06	78-04130	29,20	78-04131	32,00
YFZ350 Banshee	1991-06	78-04132	29,20	78-0	

TAKAVARREN PUSLASARJA/LAAKERISARJA



ARCTIC CAT	Malli	Tuotenro.	Hinta
250 2x4	1999-05	78-331050	73,00
250 4x4	2001-05	78-331050	73,00
300 2x4	1998-04	78-331050	73,00
300 4x4	1998-05	78-331050	73,00
400 FIS 2x4 w/AT	2004	78-331048	32,00
400 FIS 2x4 w/AT	2003	78-331049	99,00
400 FIS 2x4 w/MT	2003	78-331049	99,00
400 FIS 4x4 w/AT	2004-08	78-331048	32,00
400 FIS 4x4 w/AT	2003	78-331049	99,00
400 FIS 4x4 w/MT	2004-08	78-331048	32,00
400 FIS 4x4 w/MT	2002-03	78-331049	99,00
400 TBX 4x4	2005-06	78-331048	32,00
400 TBX 4x4	2004	78-331049	99,00
400 TRV FIS 4x4	2009-13	78-331048	32,00
500 FIS 4x4 w/AT	2004-09	78-331048	32,00
500 FIS 4x4 w/AT	2002-03	78-331049	99,00
500 FIS 4x4 w/MT	2004-09	78-331048	32,00
500 FIS 4x4 w/MT	2002	78-331049	99,00
500 TBX FIS 4x4	2005-06	78-331048	32,00
500 TBX FIS 4x4	2003-04	78-331049	99,00
500 TRV 4x4	2013	78-331048	32,00
500 TRV FIS 4x4	2008	78-331048	32,00
500 TRV FIS 4x4	2005-06	78-331048	32,00
500 TRV FIS 4x4	2003-04	78-331049	99,00
500 XT EFI 4x4	2013	78-331048	32,00
550i EFI 4x4	2012-13	78-331048	32,00
550 GT EFI 4x4	2012	78-331048	32,00
550 H1 FIS 4x4	2009-11	78-331048	32,00
550 Prowler Xt 4x4	2009-13	78-331048	32,00
550 TRV 4x4 w/AT	2013	78-331048	32,00
550 TRV 4x4 w/AT	2009-11	78-331048	32,00
550i TRV GT EFI 4x4	2012	78-331048	32,00
550 TRV XT 4x4	2013	78-331048	32,00
550 XT EFI 4x4	2013	78-331048	32,00
650i 4x4	2012	78-331048	32,00
650 H1 4x4	2005-11	78-331048	32,00
650 H1 Mud Pro 4x4	2010-11	78-331048	32,00
650 Prowler XT 4x4	2006-09	78-331048	32,00
650 V2 4x4	2004-06	78-331048	32,00
700 Diesel 4x4	2008-11	78-331048	32,00
700 Diesel EFI 4x4	2012-13	78-331048	32,00
700 EFI 4x4	2007-12	78-331048	32,00
700 H1 EFI 4x4	2008-11	78-331048	32,00
700i Mud Pro 4x4	2012-13	78-331048	32,00
700 H1 Mud Pro 4x4	2009-12	78-331048	32,00
700 H1 TRV 4X4	2008-11	78-331048	32,00
700 GT EFI 4x4	2012	78-331048	32,00
700 LTD EFI 4x4	2013	78-331048	32,00
700 Prowler HDX 4x4	2012	78-331048	32,00
700 Prowler XTX 4x4	2008-12	78-331048	32,00
700i TRV Cruiser EFI 4x4	2012	78-331048	32,00
700i TRV GT EFI 4x4	2012	78-331048	32,00
700 XT 4x4	2013	78-331048	32,00
1000 Cruiser 4x4	2012	78-331048	32,00
1000i GT 4x4	2012	78-331048	32,00
1000 Mud Pro 4x4	2012	78-331048	32,00
1000 Mud Pro H2 4x4	2010-11	78-331048	32,00
1000i Mud Pro LTD 4x4	2012-13	78-331048	32,00
1000 Prowler XTZ 4x4	2012-13	78-331048	32,00
1000 Prowler H2 XTZ 4x4	2009-11	78-331048	32,00
1000 Thunder Cat 4x4	2008-11	78-331048	32,00
1000 TRV GT 4x4	2012	78-331048	32,00
1000 TRV LTD 4x4	2013	78-331048	32,00
1000 XT 4x4	2013	78-331048	32,00

CAN-AM	Malli	Tuotenro.	Hinta
330 Outlander	2004-05	78-331046	46,00
400 Outlander	2003-14	78-331046	46,00
500 Outlander 4x4	2013-14	78-331052	42,00
500 Outlander	2007-12	78-331046	46,00
500 Renegade 4x4	2013-14	78-331052	42,00
500 Renegade	2008-12	78-331046	46,00
650 Outlander 4x4	2013-14	78-331052	42,00
650 Outlander	2007-12	78-331046	46,00
800 Outlander 4x4	2013-14	78-331052	42,00
800 Outlander STD/XT 4x4	2012	78-331052	42,00
800 Outlander	2006-11	78-331046	46,00
800 Outlander 4x4 w/po78-r steering	2012	78-331046	46,00
800 Outlander Max 4x4	2012	78-331046	46,00
800 Outlander Max 4x4 w/po78-r steering	2012	78-331046	46,00
800 Outlander Xmr 4x4	2012	78-331046	46,00
800 Renegade 4x4	2012-14	78-331052	42,00
800 Renegade	2007-11	78-331046	46,00
800 Commander	2011-14	78-331047	34,00
1000 Commander	2011-14	78-331047	34,00
1000 Outlander 4x4	2012-14	78-331052	42,00
1000 Renegade 4x4	2012-14	78-331052	42,00

HONDA	Malli	Tuotenro.	Hinta
TRX 420 FA/FPA	2009-14	78-331045	99,00
TRX 650 Rincon	2003-05	78-331035	109,00
TRX 680 Rincon	2006-14	78-331035	109,00

KAWASAKI	Malli	Tuotenro.	Hinta
650i Brute Force	2006-13	78-331043	109,00
750 Brute Force	2005-13	78-331043	109,00
750 Brute Force EPS	2012-14	78-331043	109,00

SUZUKI	Malli	Tuotenro.	Hinta
LTA 450 X King Quad	2008-10	78-331044	123,00
LTA 450 X King Quad	2007	78-331041	99,00
LTA 500 X	2009-13	78-331051	99,00
LTA 700 X King Quad	2005-07	78-331041	99,00
LTA 750 X King Quad	2008-13	78-331051	99,00

YAMAHA	Malli	Tuotenro.	Hinta
350 Grizzly IRS 4x4	2007-11	78-331034	91,00
400 Big Bear IRS	2007-12	78-331034	91,00
400 Grizzly IRS	2007-12	78-331034	91,00
450 Grizzly EPS 4x4	2013-14	78-331034	91,00
450 Grizzly IRS	2007-14	78-331034	91,00
450 Kodiak	2005-06	78-331034	91,00
450 Rhino	2006-09	78-331034	91,00
550 Grizzly	2009-14	78-331034	91,00
550 Grizzly EPS 4x4	2009-14	78-331034	91,00
550 Grizzly EPS	2009-12	78-331034	91,00
660 Grizzly	2002-08	78-331034	91,00
660 Rhino	2004-07	78-331034	91,00
700 Grizzly	2007-13	78-331034	91,00
700 Grizzly EPS	13	78-331034	91,00
700 Rhino FI	2011-12	78-331034	91,00
700 Rhino FI	2008-13	78-331034	91,00

TAKA-HAARUKAN PUSLASARJAT



ARCTIC CAT	Malli	Tuotenro.	Hinta
250 2x4	2006-12	78-347056	38,00
300 2x4	2010-11	78-347056	38,00
400 DVX	2004-08	78-347065	58,00

CAN-AM	Malli	Tuotenro.	Hinta
450 DS EFI MXC 2x4	2009	78-347087	55,00
450 DS EFI XXC 2x4	2009	78-347087	55,00
450 DS STD/X 2x4	2008-09	78-347087	55,00
500 Quest	2002-03	78-347021	38,00
500 Traxter	1999-05	78-347021	38,00
650 Quest	2002-04	78-347021	38,00
650 Traxter	2004-05	78-347021	38,00



ATV



TAKA-HAARUKAN PUSLASARJAT JATKUU



HONDA	Malli	Tuotenro.	Hinta
TRX 200	1984	78-347056	38,00
250 ES/SX	1985-87	78-347056	38,00
TRX 250 EX Sportrax	2001-14	78-347056	38,00
TRX 250 Fourtrax	1985-87	78-347056	38,00
TRX 250 Recon	1997-14	78-347056	38,00
TRX 300 Fourtrax 4x4	1988-00	78-347056	38,00
TRX 300 FW Fourtrax 4x4	1988-00	78-347056	38,00
TRX 350 FE/FM Fourtrax Rancher	2000-06	78-347056	38,00
TRX 350 TE/TM Fourtrax Rancher	2000-06	78-347056	38,00
TRX 400 FW Fourtrax Foreman 4x4	1995-03	78-347056	38,00
TRX 420 FE/FM	2007-13	78-347070	62,00
TRX 420 FPE/FPM	2011-12	78-347070	62,00
TRX 420 TE/TM	2007-10	78-347070	62,00
TRX 450 ER	2006-14	78-347035	49,00
TRX 450 R	2004-09	78-347035	49,00
TRX 450 ES/S	1998-01	78-347056	38,00
TRX 500 FA	2001-13	78-347056	38,00
TRX 500 FE	2012-13	78-347070	62,00
TRX 500 FE	2005-11	78-347056	38,00
TRX 500 FM	2012-13	78-347070	62,00
TRX 500 FM	2005-11	78-347056	38,00
TRX 500 FGA	2004-09	78-347056	38,00
TRX 500 FPA	2009-13	78-347056	38,00
TRX 500 FPE/FPM	2012-13	78-347070	62,00
TRX 500 FPE/FPM	2008-11	78-347056	38,00
TRX 500 TM	2005-06	78-347056	38,00

KAWASAKI	Malli	Tuotenro.	Hinta
300 Prairie	1999-02	78-347059	34,00
360 Prairie	2003-13	78-347059	34,00
400 Prairie	1997-02	78-347059	34,00
KFX 450R	2008-14	78-347069	34,00
650 Brute Force (straight axle)	2005-12	78-347059	34,00
650 Prairie	2002-03	78-347059	34,00
700 KFX	2004-09	78-347059	34,00
700 Prairie	2004-06	78-347059	34,00

POLARIS	Malli	Tuotenro.	Hinta
250 Trail Blazer 2x4	2006	78-345575	21,00
250 Trail Blazer 2x4	1999-05	78-345530	42,00
250 Trail Blazer 2x4	1995-98	78-345501	99,00
250 Trail Boss 2x4	1995-99	78-345501	99,00
250 Xplorer 4x4	2000-02	78-345530	42,00
300 2x4/4x4	1995	78-345501	99,00
300 Xplorer 4x4	1996-99	78-345501	99,00
300 Xpress 2x4	1996-99	78-345501	99,00
325 Magnum 2x4/4x4	2000-02	78-345545	52,00
325 Trail Boss 2x4	2000-02	78-345530	42,00
325 Xpedition 4x4	2000-02	78-345545	52,00
330 ATP 4x4	2004-05	78-345570	68,00
330 Magnum 2x4	2004-05	78-345570	68,00
330 Magnum 4x4	2004-06	78-345570	68,00
330 Trail Blazer 2x4	2008-12	78-345575	21,00
330 Trail Boss 2x4	2004-12	78-345575	21,00
330 Trail Boss 2x4	2003	78-345530	42,00
335 Sportsman 4x4	1999	78-345535	136,00
400 2x4	1995	78-345501	99,00
400 Big Boss 6x6	1995-97	78-345501	99,00
400 Ranger EV	2010	78-345585	72,00
400 Ranger HO 4x4	2010-11	78-345585	72,00
400 Scrambler 2x4	2000-01	78-345530	42,00
400 Scrambler 4x4	1998-02	78-345530	42,00
400 Scrambler 4x4	1995-97	78-345501	99,00
400 Sport 2x4	1999	78-345530	42,00
400 Sport 2x4	1995-98	78-345501	99,00
400 Sportsman 4x4	2003-05	78-345560	48,00
400 Sportsman 4x4	2001-02	78-345535	136,00

400 Sportsman 4x4	1995-97	78-345501	99,00
400 Trail Blazer 2x4	2003	78-345530	42,00
400 Xplorer 4x4	1999-02	78-345530	42,00
400 Xplorer 4x4	1995-98	78-345501	99,00
400 Xpress 2x4	1996-97	78-345501	99,00
425 Magnum 2x4/4x4	1996-98	78-345501	99,00
425 Magnum 6x6	1996-97	78-345501	99,00
425 Xpedition 4x4	2000-02	78-345545	52,00
450 Sportsman 4x4	2006-07	78-345560	48,00
500 ATP 4x4	2004-05	78-345570	68,00
500 Big Boss 6x6	1999	78-345501	99,00
500 Magnum 4x4	2000-02	78-345545	52,00
500 Magnum RMK 4x4	2002	78-345545	52,00
500 Predator 2x4	2004-06	78-345580	182,00
500 Ranger 2x4	2005-09	78-345585	72,00
500 Ranger 4x4	2005-07	78-345585	72,00
500 Ranger 4x4	2004	78-345575	21,00
500 Ranger 6x6	2004-05	78-345575	21,00
500 Ranger EFI 4x4	2006-10	78-345585	72,00
500 Scrambler 2x4	2001-02	78-345530	42,00
500 Scrambler 4x4	2006-12	78-345575	21,00
500 Scrambler 4x4	1998-05	78-345530	42,00
500 Scrambler 4x4	1997	78-345501	99,00
500 Sportsman 4x4	1996-01	78-345535	136,00
500 Sportsman EFI 4x4	2006-09	78-345560	48,00
500 Sportsman HO 4x4	2003-06/2008-10	78-345560	48,00
500 Sportsman HO 4x4	2001-02	78-345535	136,00
500 Sportsman 6x6	2006-08	78-345575	21,00
500 Sportsman 6x6	2001-05	78-345530	42,00
500 Xplorer 4x4	1997	78-345535	136,00
600 Sportsman 4x4	2003-05	78-345560	48,00
700 MV7 4x4	2005	78-345560	48,00
700 Ranger Crew 4x4	2008-09	78-345585	72,00
700 Ranger HD 4x4	2009	78-345585	72,00
700 Ranger XP 4x4	2005-09	78-345585	72,00
700 Ranger EFI 6x6	2009	78-345585	72,00
700 Ranger EFI 6x6	2006-08	78-345575	21,00
700 Sportsman 4x4	2003-06	78-345560	48,00
700 Sportsman 4x4	2002	78-345535	136,00
700 Sportsman EFI 4x4	2004-07	78-345560	48,00
800 Ranger 6x6	2010-11	78-345585	72,00
800 Ranger Crew 4x4	2010	78-345585	72,00
800 Ranger HD 4x4	2010-11	78-345585	72,00
800 Ranger XP 4x4	2010-11	78-345585	72,00
800 Sportsman EFI 4x4	2009-10	78-345560	48,00
800 Sportsman EFI HO 4x4	2008	78-345560	48,00
800 Sportsman EFI 4x4	2005-07	78-345560	48,00
900 Ranger Diesel 4x4	2010	78-345585	72,00
Diesel	1999-01	78-345535	136,00
Ranger TM 2x4	2004-06	78-345575	21,00

SUZUKI	Malli	Tuotenro.	Hinta
LT 230E	1987-96	78-347023	47,00
LT 230S	1985-88	78-347023	47,00
LT 250S	1989-90	78-347023	47,00
LT-Z 400	2012-13	78-347065	58,00
LT-Z 400	2003-09	78-347065	58,00
LT-A 500F Vinson	2002-07	78-347067	38,00
LT-F 500F Vinson	2003-07	78-347067	38,00
LT-V 700F Twin Peaks	2004-06	78-347059	34,00

YAMAHA	Malli	Tuotenro.	Hinta
200 Moto 4	1986-89	78-347058	38,00
225 Moto 4	1986-88	78-347058	38,00
250 Beartracker	1999-04	78-347039	38,00
250 Big Bear	2007-09	78-347039	38,00
250 Bruin	2005-06	78-347039	38,00
250 Moto 4	1989-91	78-347058	38,00
250 Timberwolf	1992-00	78-347058	38,00
250 Tri-Moto	1983-86	78-347058	38,00
350 Big Bear	1987-99	78-347058	38,00
350 Moto 4	1987-95	78-347058	38,00
350 Wolverine	1995-05	78-347058	38,00
400 Big Bear 2WD	2000-04	78-347039	38,00
400 Big Bear 4WD	2000-06	78-347039	38,00
400 Kodiak 4WD	1993-99	78-347058	38,00
600 Grizzly	1998-01	78-347058	38,00
700 Raptor	2006-14	78-347052	65,00

-  Vanteet ja renkaat
-  Talvituotteet
-  Vinssit
-  Laukut ja tuulisuojat
-  Sähköosat
-  Jousitus ja voimansiirto
-  Pakoputket ja suutinsarjat
-  Ohjaukset
-  Rungon osat ja peitteet
-  Jarrupalat ja rattaat
-  Moottori
-  Variaattorin osat
-  Maatalous-tarvikkeet
-  Kärryt ja reet

ATV

PYÖRÄN LAAKERIT & SOPIVUUS



PYÖRÄN ÖLJYTIIVISTEET: MITAT JA HINNAT



Tuotenro	Koodi	Mitat (mm)			Hinta	Sopivuus
22-511	6001-2RS	12	28	8	5,90	Yamaha
22-513	6002-2RS	15	32	9	6,20	Honda,Suzuki
22-518	6003-2RS	17	35	10	6,70	Honda,Polaris,Yamaha
22-521	6004-2RS	20	42	12	6,30	Honda,Kawasaki,Yamaha,Suzuki
22-520	6005-2RS	25	47	12	12,00	Yamaha
22-522	6006-2RS	30	55	13	10,70	Honda,Polaris,Yamaha,Suzuki
22-700	6007-2RS	35	62	14	11,40	Honda,Kawasaki,Polaris,Yamaha,Suzuki
22-702	6008-2RS	40	68	15	15,40	Kawasaki,Polaris,Yamaha,Suzuki
22-703	6009-2RS	45	75	16	19,80	Suzuki
22-732	6028-2RS	28	52	12	18,70	Honda,Yamaha,Suzuki
22-733	6032-2RS	32	58	13	30,20	Honda,Suzuki
22-547	6202-2RS	15	35	11	7,20	Honda,Kawasaki,Yamaha,Suzuki
22-551	6203-2RS	17	40	12	6,50	Kawasaki,Yamaha,Suzuki
22-556	6204-2RS	20	47	12	7,50	Polaris,Suzuki
22-561	6205-2RS	25	52	15	7,10	Honda,Kawasaki
22-734	6206-2RS	30	62	16	11,80	Kawasaki,Polaris
22-736	6232-2RS	32	65	12	34,70	Suzuki
22-593	6302-2RS	15	42	13	8,60	Honda,Yamaha
22-726	6904-2RS	20	37	9	23,70	Honda,Yamaha
22-728	6905-2RS	25	42	9	31,70	Suzuki
22-737	6908-2RS	40	62	12	56,50	Kawasaki
22-706	6909-2RS	45	68	12	82,70	Honda
22-739	DG4070A	40	70	15	62,60	Yamaha
22-740	DG5080	50	80	21	67,60	Yamaha

Tuotenro	Mitat	Korvaa. alkup.nro	Ovh.
79-058041	52x62x7/9		4,30
79-058044	28x42x6	Honda 91257-VM0-004	3,70
79-058052	50x68x7	Suzuki 09283-50006	6,30
79-158300	40x58x7	Arctic Cat 0402-069	5,30
79-158301	40x55x6	Arctic Cat 0402-089	4,30
79-158304	51x28x6	Polaris 3610020	4,30
79-158308	O-Rengas	Polaris 5410470	2,30
79-158309	62x44x6	Polaris 3610013	5,30
79-158310	35x52x8	Yamaha 93101-35097-00	4,30
79-158311	46x70x8	Yamaha 93102-46377-00	5,30
79-158312	38x55x8	Yamaha 93102-38383-00	4,30
79-158313	44x62x10	Honda 91252-HB3-003	5,30
79-158317	40x58x6		5,30
79-158319	47x70x8,5	Yamaha 93106-47040-00	6,30
79-158320	20x35x7	Honda 91257-HB3-003	3,70
79-158321	42x70x8	Yamaha 93106-42037-00	5,30
79-158322	28x42x8		3,70
79-158323	38x50x7	Honda 91256-HC5-003	4,30
79-158327	42x58x10	Honda 91255-HA0-681	5,30
79-158328	40x58x8	Suzuki 09283-40018	5,30
79-158330	21,5x35x8		3,70
79-158331	21x35x8		3,70
79-158332	34x58x6	Honda 91252-HM7-003	4,30
79-158333	30x42x8	Kawasaki 92049-1236	4,30
79-158334	26x42x7	Kawasaki 92039-S034	4,30



PYÖRÄN LAAKERIT



79-06600



79-06601



79-06602



79-06604



79-06606



79-06607



79-06608



79-06609



79-06610



79-06611



79-06613



79-06614



79-06615



79-06617



79-06618



79-06620



79-06621



79-06622



79-06623



79-06624

ATV





PYÖRÄN LAAKERIT JATKUU



Vanteet ja renkaat



Talvituotteet



Vinssit



Laukut ja tuulisuojat



Sähköosat



Jousitus ja voimansiirto



Pakoputket ja suutinsarjat



Ohjaus



Rungon osat ja peitteet



Jarrupalat ja rattaat



Moottori



Variaattorin osat



Maatalous-tarvikkeet



Kärryt ja reet

ATV



79-06625



79-06626



79-06629



79-06630



79-06631



79-06632

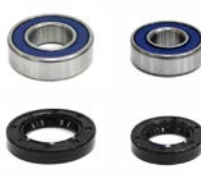

79-06635



79-06636



79-06637



79-06639



79-06640



79-06642



79-06643



79-06644



79-06646



79-06647



79-06648



79-06650



79-06651



79-06652



79-06654



79-06656



79-06657



79-06661



79-06662



79-06663



79-06665



79-06666



79-06667



79-06668

PYÖRÄN LAAKERIT: SOPIVUUDET

ARCTIC CAT						
CC	Malli	Vuosim.	Eteen	Hinta	Taakse	Hinta
250	250 2x4	1999-05	79-06623	21,20	79-06623	21,20
250	250 2x4	2006-09	79-06654	14,50		
250	250 4x4	2001-04	79-06623	21,20	79-06623	21,20
250	250 4x4	2005	79-06624	18,20	79-06624	18,20
250	DVX250	2006-08	79-06654	14,50		
300	300 2x4	1998-04	79-06623	21,20	79-06623	21,20
300	300 2x4	2010-12	79-06654	14,50		
300	300 4x4	1998-04	79-06623	21,20	79-06623	21,20
300	300 4x4	2005	79-06624	18,20	79-06624	18,20
300	DVX300	2009-12	79-06654	14,50		
350	350 Utility 4x4	2011	79-06624	18,20	79-06624	18,20
366	350 CR	2012	79-06624	18,20	79-06624	18,20
366	366 FIS w/AT	2008-11	79-06624	18,20	79-06624	18,20

375	375 2x4 w/AT	2002	79-06623	21,20		
375	375 4x4 w/AT	2002	79-06623	21,20		
400	400 2x4	1998-00	79-06623	21,20		
400	400 2x4	2001	79-06623	21,20		
400	400 4x4	1998-00	79-06623	21,20		
400	400 4x4 w/AT	2003-04	79-06623	21,20		
400	400 4x4 w/MT	2001-04	79-06623	21,20		
400	400 FIS 2x4 w/AT	2003	79-06623	21,20	79-06623	21,20
400	400 FIS 2x4 w/MT	2003	79-06623	21,20	79-06623	21,20
400	400 FIS 2x4 w/AT	2004	79-06623	21,20	79-06623	21,20
400	400 FIS 2x4 w/MT	2004	79-06623	21,20	79-06623	21,20
400	400 FIS 4x4 TRV	2009-13	79-06624	18,20	79-06624	18,20
400	400 FIS 4x4 w/AT	2003-04	79-06623	21,20	79-06623	21,20
400	400 FIS 4x4 w/AT	2005-08	79-06624	18,20	79-06624	18,20
400	400 FIS 4x4 w/MT	2002-04	79-06623	21,20	79-06623	21,20



ARCTIC CAT						
CC	Malli	Vuosim.	Eteen	Hinta	Taakse	Hinta
400	400 FIS 4x4 w/MT	2005-08	79-06624	18,20	79-06624	18,20
400	400 TBX 4x4	2004	79-06623	21,20	79-06623	21,20
400	400 TBX 4x4	2005-06	79-06624	18,20	79-06624	18,20
400	400 TRV	2007	79-06624	18,20	79-06624	18,20
400	400 VP 4x4	2006	79-06624	18,20	79-06624	18,20
425	425 4x4	2011-12	79-06624	18,20	79-06624	18,20
450	450 H1	2010-11	79-06624	18,20	79-06624	18,20
450	450i EFI	2012	79-06624	18,20	79-06624	18,20
450	450i TRV EFI	2012	79-06624	18,20	79-06624	18,20
450	450i TRV GT EFI	2012	79-06624	18,20	79-06624	18,20
450	450XC 4x4	2011-12	79-06624	18,20	79-06624	18,20
450	550 TRV XT	2013	79-06624	18,20	79-06624	18,20
454	454 2x4	1997-98	79-06623	21,20		
454	454 4x4	1996-98	79-06623	21,20		
500	500 4x4	1998-99	79-06623	21,20		
500	500 4x4 w/AT	2000-02	79-06623	21,20		
500	500 4x4 w/MT	2000-01	79-06623	21,20		
500	500 EFI	2013	79-06624	18,20	79-06624	18,20
500	500 FIS 4x4 w/AT	2002-04	79-06623	21,20	79-06623	21,20
500	500 FIS 4x4 w/AT	2005-09	79-06624	18,20	79-06624	18,20
500	500 FIS 4x4 w/MT	2002-04	79-06623	21,20	79-06623	21,20
500	500 FIS 4x4 w/MT	2005-09	79-06624	18,20	79-06624	18,20
500	500 FIS TBX 4x4	2002	79-06623	21,20		
500	500 FIS TBX 4x4	2003-04	79-06623	21,20	79-06623	21,20
500	500 FIS TBX 4x4	2005-06	79-06624	18,20	79-06624	18,20
500	500 FIS TRV 4x4	2003-04	79-06623	21,20	79-06623	21,20
500	500 FIS TRV 4x4	2005-06	79-06624	18,20	79-06624	18,20
500	500 FIS TRV 4x4	2008	79-06624	18,20	79-06624	18,20
500	500 TRV	2013	79-06624	18,20	79-06624	18,20
500	500 XT EFI	2013	79-06624	18,20	79-06624	18,20
550	550 EFI 4X4	2013	79-06624	18,20	79-06624	18,20
550	550 GT EFI 4X4	2012	79-06624	18,20	79-06624	18,20
550	550 H1 FIS 4X4	2009-11	79-06624	18,20	79-06624	18,20
550	550 i EFI 4X4	2012	79-06624	18,20	79-06624	18,20
550	550 TRV 4X4	2013	79-06624	18,20	79-06624	18,20
550	550 TRV 4x4 w/AT	2009-11	79-06624	18,20	79-06624	18,20
550	550 XT EFI 4X4	2013	79-06624	18,20	79-06624	18,20
550	550i TRV GT EFI 4X4	2012	79-06624	18,20	79-06624	18,20
650	650 4x4 H1	2005-11	79-06624	18,20	79-06624	18,20
650	650 4x4 H1 Mud Pro	2010-11	79-06624	18,20	79-06624	18,20
650	650 4x4 w/AT V2	2004	79-06623	21,20	79-06624	18,20
650	650 4x4 w/AT V2	2005-06	79-06624	18,20	79-06624	18,20
650	650i 4x4	2012	79-06624	18,20	79-06624	18,20
700	700 Diesel	2008-11	79-06624	18,20	79-06624	18,20
700	700 EFI 4x4	2007-12	79-06624	18,20	79-06624	18,20
700	700 EFI H1 MU-DPRO	2009-11	79-06624	18,20	79-06624	18,20
700	700 EFI H1 w/AT	2008-11	79-06624	18,20	79-06624	18,20
700	700 GT EFI	2012	79-06624	18,20	79-06624	18,20
700	700 H1 TRV	2008-11	79-06624	18,20	79-06624	18,20
700	700 LTD EFI	2013	79-06624	18,20	79-06624	18,20
700	700 XT	2013	79-06624	18,20	79-06624	18,20
700	700i Diesel EFI	2012-13	79-06624	18,20	79-06624	18,20
700	700i EFI MUDPRO	2012-13	79-06624	18,20	79-06624	18,20
700	700i TRV Cruiser EFI	2012	79-06624	18,20	79-06624	18,20
700	700i TRV GT EFI	2012	79-06624	18,20	79-06624	18,20
1000	1000 Cruiser	2012	79-06624	18,20	79-06624	18,20
1000	1000 TRV GT	2012	79-06624	18,20	79-06624	18,20
1000	1000 TRV LTD	2013	79-06624	18,20	79-06624	18,20
1000	1000 XT	2013	79-06624	18,20	79-06624	18,20
1000	1000i GT	2012	79-06624	18,20	79-06624	18,20
1000	1000i LDT EFI MUDPRO	2012-13	79-06624	18,20	79-06624	18,20
1000	H2 MUDPRO	2010-11	79-06624	18,20	79-06624	18,20
1000	H2 THUNDERCAT	2008-11	79-06624	18,20	79-06624	18,20
UTV						
550	550 Prowler XT	2009-13	79-06624	18,20	79-06624	18,20
650	650 Prowler XT	2006-09	79-06624	18,20	79-06624	18,20
700	700 Prowler HDX	2012	79-06624	18,20	79-06624	18,20
700	700 Prowler XTX	2008-12	79-06624	18,20	79-06624	18,20
1000	1000 Prowler XTZ	2011-13	79-06624	18,20	79-06624	18,20
1000	Prowler H2 1000 XTZ	2009-11	79-06624	18,20	79-06624	18,20
1000	Wildcat GT	2012	79-06624	18,20		

Can-Am						
CC	Malli	Vuosim.	Eteen	Hinta	Taakse	Hinta
400	Outlander 400	2006-13	79-06631	19,20	79-06631	19,20
450	DS 450 EFI MXC	2009-12	79-06631	19,20		
450	DS 450 EFI XXC	2009-12	79-06631	19,20		
450	DS 450 STD/X	2008	79-06631	19,20		
450	DS 450 STD/X	2009-12	79-06631	19,20		
500	Outlander 500	2007-13	79-06631	19,20	79-06631	19,20
500	Renegade 500	2008-13	79-06631	19,20	79-06631	19,20
650	Outlander 650	2007-13	79-06631	19,20	79-06631	19,20
800	Outlander 800	2006-13	79-06631	19,20	79-06631	19,20
800	Renegade 800	2007-13	79-06631	19,20	79-06631	19,20
1000	Outlander 1000	2012-13	79-06631	19,20	79-06631	19,20
1000	Renegade 1000	2012-13	79-06631	19,20	79-06631	19,20
UTV						
800	Commander 800	2011-13	79-06631	19,20	79-06631	19,20
1000	Commander 1000	2011-13	79-06631	19,20	79-06631	19,20
CF-Moto						
CC	Malli	Vuosim.	Eteen	Hinta	Taakse	Hinta
500	ATV 500		79-06624	18,20	79-06624	18,20
500	X-LANDER		79-06624	18,20	79-06624	18,20
UTV						
500	TERRACROSS		79-06624	18,20		
Honda						
CC	Malli	Vuosim.	Eteen	Hinta	Taakse	Hinta
70	ATC70	1978-85			79-06610	14,20
70	TRX70	1986-87			79-06610	14,20
200	TRX200	1990-91	79-06629	13,20		
200	TRX200	1996-97	79-06629	13,20		
200	TRX200D	1990-97	79-06629	13,20		
250	TRX250 Recon	1997-13	79-06629	13,20	79-06640	31,50
250	TRX250EX Sportrax	2001-12	79-06642	14,50	79-06640	31,50
250	TRX250R	1986-87			79-06617	20,00
250	TRX250R	1988-89	79-06654	14,50	79-06617	20,00
250	TRX250X	1987-88	79-06654	14,50	79-06617	20,00
250	TRX250X	1991-92	79-06654	14,50	79-06617	20,00
300	TRX300 EX	1993-09	79-06654	14,50	79-06617	20,00
300	TRX300 Fourtrax 300	1988-92	79-06654	14,50	79-06611	14,20
300	TRX300 Fourtrax 300	1993-00			79-06611	14,20
300	TRX300FW Fourtrax 4x4	1988-00	79-06600	21,20	79-06611	14,20
350	TRX350D	1987-89	79-06601	24,50		
350	TRX350	1987	79-06601	24,50		
350	TRX350FE/FM	2000-06	79-06630	21,20	79-06609	24,20
350	TRX350TE/TM	2000-06	79-06629	13,20	79-06609	24,20
400	TRX400EX	1999-01	79-06654	14,50	79-06617	20,00
400	TRX400EX	2002-09	79-06642	14,50	79-06617	20,00
400	TRX400FA/FGA	2004-07	79-06630	21,20	79-06609	24,20
400	TRX400FW Fourtrax Foreman 4X4	1995-03	79-06602	19,20	79-06609	24,20
400	TRX400X	2012-13	79-06642	14,50	79-06617	20,00
420	TRX420 FA/FPA	2009-13	79-06600	21,20	79-06656	24,00
420	TRX420 FE/FM	2007-13	79-06600	21,20		
420	TRX420 FPE/FPM	2011-13	79-06600	21,20		
450	TRX450ER	2006-09	79-06642	14,50	79-06647	23,50
450	TRX450ER	2012-13	79-06642	14,50	79-06647	23,50
450	TRX450ES	1998-01	79-06602	19,20	79-06609	24,20
450	TRX450FE/FM	2002-04	79-06602	19,20	79-06609	24,20
450	TRX450R	2004-09	79-06642	14,50	79-06647	23,50
450	TRX450S	1998-01	79-06602	19,20	79-06609	24,20
500	TRX500FA	2001-04	79-06602	19,20	79-06609	24,20
500	TRX500FA/FE/FM	2005-13	79-06637	25,00	79-06609	24,20
500	TRX500FGA	2004	79-06602	19,20	79-06609	24,20
500	TRX500FGA	2005-09	79-06637	25,00	79-06609	24,20
500	TRX500FPA	2009-13	79-06637	25,00	79-06609	24,20
500	TRX500FPE/FPM	2008-13	79-06637	25,00	79-06609	24,20
500	TRX500TM	2005-06			79-06609	24,20
650	TRX650 Rincon	2003-05	79-06602	19,20	79-06660	24,20
680	TRX680 Rincon	2006-13	79-06637	25,00	79-06660	24,20
700	TRX700XX	2008-09			79-06656	24,00



Vanteet ja renkaat



Talvituotteet



Vinsit



Laukut ja tuulisuojat



Sähköosat



Jousitus ja voimansiirto



Pakoputket ja suutinsarjat



Ohjaus



Rungon osat ja peitteet



Jarrupalat ja rattaat



Moott



Vanteet ja renkaat



Talvituetteet



Vinssit



Laukut ja tuulisuojat



Sähköosat



Jousitus ja voimansiirto



Pakoputket ja suutinsarjat



Ohjauk



Rungon osat ja peitteet



Jarrupalat ja ratat



Moottori



Variaattorin osat



Maatalous-tarvikkeet



Kärryt ja reet

Kawasaki						
CC	Malli	Vuosim.	Eteen	Hinta	Taakse	Hinta
250	KSF250 Mojave	1987-04			79-06644	19,50
250	KXF250 Tecate	1987-88			79-06644	19,50
250	KXT250 Tecate	1986-87			79-06644	19,50
300	KEF300 Lakota	1995-03			79-06644	19,50
300	KLF300A Bayou	1986-87			79-06663	16,50
300	KLF300B Bayou	1988-04			79-06663	16,50
300	KLF300C Bayou 4X4	1989-04	79-06627	21,20		
300	KVF300 Brute Force	2012-13	79-06654	14,50		
300	KVF300A Prairie 4x4	1999-02	79-06627	21,20		
300	KVF300B Prairie 2x4	1999-00	79-06627	21,20		
300	KVF300B Prairie 2x4	2001-02	79-06627	21,20		
360	KVF360A & C Prairie 4x4	2003-13	79-06627	21,20		
360	KVF360B Prairie	2003-10	79-06627	21,20		
400	KFX400	2003-06	79-06636	19,00	79-06620	17,20
400	KLF400 Bayou	1993-99	79-06627	21,20		
400	KVF400A Prairie 4x4	1997-98	79-06627	21,20		
400	KVF400B Prairie	1998	79-06627	21,20		
400	KVF400C Prairie 4x4	1999-01	79-06627	21,20		
400	KVF400C Prairie 4x4	2002	79-06627	21,20		
400	KVF400D Prairie	1999-00	79-06627	21,20		
400	KVF400D Prairie	2001-02	79-06627	21,20		
400	Mule 600	2005-2009	79-06633	16,20		
400	Mule 610 4X4	2005-2009	79-06633	16,20		
450	KFX450R	2008-13	79-06654	14,50	79-06652	23,50
650	KVF650 Brute force	2005-12	79-06627	21,20		
650	KVF650 I Brute force	2006-2009			79-06633	16,20
650	KVF650 Prairie	2002-03	79-06627	21,20		
700	KFX 700 V-Force	2004-09	79-06654	14,50		
700	KVF700 Prairie	2004-06	79-06627	21,20		
750	KVF750 Brute Force	2005-2009			79-06633	16,20
750	TERYX 750 4X4	2008			79-06633	16,20

UTV						
CC	Malli	Vuosim.	Eteen	Hinta	Taakse	Hinta
500	Mule 500	1991-95	79-06661	19,50	79-06663	16,50
520	Mule 520	2000-01	79-06661	19,50	79-06663	16,50
550	Mule 550	1997-04	79-06661	19,50	79-06663	16,50
1000	Mule 1000	1988	79-06661	19,50	79-06665	20,00
2010	Mule 2010	1990	79-06662	15,00	79-06665	20,00
2020	Mule 2020	1990	79-06662	15,00	79-06665	20,00
2030	Mule 2030	1991	79-06662	15,00	79-06665	20,00
2500	Mule 2500	1994-00	79-06662	15,00	79-06665	20,00
2510	Mule 2510 4x4	1993-00	79-06662	15,00	79-06665	20,00
2510	Mule 2510 Diesel	2000-02	79-06662	15,00	79-06665	20,00
2520	Mule 2520	1993-00	79-06662	15,00	79-06665	20,00
3000	Mule 3000	2001-08	79-06662	15,00		
3010	Mule 3010 4X4	2001-08	79-06662	15,00		
3010	Mule 3010 Diesel	2001-08	79-06662	15,00		
3020	Mule 3020	2001-03	79-06662	15,00		
4000	Mule 4000	2009-13	79-06662	15,00		
4010	Mule 4010 4x4	2009-12	79-06662	15,00		
4010	Mule 4010 4x4 Diesel	2009-13	79-06662	15,00		

Kymco						
CC	Malli	Vuosim.	Eteen	Hinta	Taakse	Hinta
250	KXR250		79-06654	14,50		
250	MAXXER250		79-06654	14,50		
250	Mongoose 250	2004-08	79-06654	14,50		
250	MXU250	2004-05	79-06654	14,50		
300	MAXXER300		79-06654	14,50		
300	Mongoose 300	2005-08	79-06654	14,50		
300	MXU 300	2005-08	79-06654	14,50		
400	MXU 400		79-06624	18,20	79-06624	18,20
500	MXU 500 2WD		79-06624	18,20		
500	MXU 500 4WD		79-06624	18,20		

UTV						
CC	Malli	Vuosim.	Eteen	Hinta	Taakse	Hinta
500	UXV 500i	2000	79-06666	22,00	79-06666	22,00
Polaris						
CC	Malli	Vuosim.	Eteen	Hinta	Taakse	Hinta
200	Phoenix 200	2005	79-06626	14,20		
250	Cyclone 250	1987			79-06618	16,20
250	Scrambler 250	1985-86			79-06618	16,20
250	Trail Blazer 250	1990-98	79-06643	23,50	79-06618	16,20
250	Trail Blazer 250	1999-04	79-06643	23,50	79-06613	19,20
250	Trail Blazer 250	2005-06	79-06626	14,20	79-06613	19,20
250	Trail Boss 250	1985-87			79-06618	16,20
250	Trail Boss 250	1988-99	79-06643	23,50	79-06618	16,20
250	Trail Boss 250 4x4	1987-88	79-06604	18,20	79-06618	16,20
250	Trail Boss 250 4x4	1989-90	79-06604	18,20	79-06618	16,20
250	Trail Boss 250 4x4	1991-93	79-06604	18,20	79-06618	16,20
250	Xplorer 250 4X4	2000-02	79-06604	18,20	79-06613	19,20
300	300 2x4	1994-95	79-06643	23,50	79-06618	16,20
300	300 4X4	1994	79-06604	18,20	79-06618	16,20
300	Hawkeye 2x4	2006-11	79-06622	19,20	79-06622	19,20
300	Hawkeye 4x4	2006-07	79-06622	19,20	79-06622	19,20
300	Sportsman 300 4X4	2008-10	79-06622	19,20	79-06622	19,20
300	Trail Boss 300 4X4	1995	79-06604	18,20	79-06618	16,20
300	Xplorer 300 4x4	1996-98	79-06604	18,20	79-06618	16,20
300	Xplorer 300 4x4	1999	79-06604	18,20		
300	Xpress 300	1996-99	79-06643	23,50	79-06618	16,20
325	Magnum 325 2x4	2000-01	79-06643	23,50		
325	Magnum 325 2x4	2002	79-06643	23,50	79-06622	19,20
325	Magnum 325 4x4	2000-01	79-06604	18,20		
325	Magnum 325 4x4	2002	79-06604	18,20	79-06622	19,20
325	Magnum 325 4x4 HDS	2001-02	79-06622	19,20	79-06622	19,20
325	Trail Boss 325	2000-02	79-06643	23,50	79-06613	19,20
325	Xpedition 325	2000-01	79-06604	18,20		
325	Xpedition 325	2002	79-06604	18,20	79-06622	19,20
330	ATP 330 4X4	2004-05	79-06622	19,20	79-06622	19,20
330	Magnum 330 2x4	2003-05	79-06643	23,50	79-06622	19,20
330	Magnum 330 4x4	2003-05	79-06622	19,20	79-06622	19,20
330	Trail Blazer 330	2008-09	79-06626	14,20	79-06613	19,20
330	Trail Blazer 330	2010-13	79-06622	19,20	79-06613	19,20
330	Trail Boss 330	2003-04	79-06643	23,50	79-06613	19,20
330	Trail Boss 330	2005-09	79-06626	14,20	79-06613	19,20
330	Trail Boss 330	2010-13	79-06622	19,20	79-06613	19,20
335	Sportsman 335	1999-00	79-06604	18,20	79-06612	39,40
335	Worker 335	1999	79-06604	18,20	79-06612	39,40
350	350L 2x4	1993	79-06643	23,50	79-06618	16,20
350	350L 4x4	1993	79-06604	18,20	79-06618	16,20
350	Sportsman 350 4x4	1993	79-06604	18,20	79-06618	16,20
350	Trail Boss 350L 2x4	1990-92	79-06643	23,50	79-06618	16,20
350	Trail Boss 350L 4x4	1990-92	79-06604	18,20	79-06618	16,20
380	Scrambler 380 2x4	2000	79-06643	23,50	79-06613	19,20
400	400L 2x4	1994-95	79-06643	23,50	79-06618	16,20
400	400L 4x4	1994	79-06604	18,20	79-06618	16,20
400	Hawkeye 400 HO 2x4	2012-13	79-06622	19,20	79-06612	39,40
400	Scrambler 400 2x4	2001-02	79-06643	23,50	79-06613	19,20
400	Scrambler 400 4x4	1995-97	79-06604	18,20	79-06618	16,20
400	Scrambler 400 4x4	1998-02	79-06604	18,20	79-06613	19,20
400	Sport 400	1994-98	79-06643	23,50	79-06618	16,20
400	Sport 400	1999	79-06643	23,50	79-06613	19,20
400	Sportsman 400 4x4	1994	79-06604	18,20	79-06618	16,20
400	Sportsman 400 4x4	1995-97	79-06604	18,20	79-06618	16,20
400	Sportsman 400 4x4	2001-03	79-06604	18,20	79-06612	39,40
400	Sportsman 400 4x4 AA AE AG	2004	79-06604	18,20	79-06612	39,40
400	Sportsman 400 4X4 AQ-AV	2004	79-06622	19,20	79-06612	39,40
400	Sportsman 400 4X4	2005	79-06622	19,20	79-06612	39,40
400	Sportsman 400 HO 4x4	2008-10	79-06622	19,20	79-06622	19,20
400	Sportsman 400 HO 4x4	2011-13	79-06622	19,20	79-06612	39,40
400	Trail Blazer 400	2003	79-06643	23,50	79-06613	19,20
400	Xplorer 400L 4x4	1995-98	79-06604	18,20	79-06618	16,20



Polaris						
CC	Malli	Vuosim.	Eteen	Hinta	Taakse	Hinta
400	Xplorer 400L 4x4	1999-02	79-06604	18,20	79-06613	19,20
400	Xpress 400L 2x4	1996-97	79-06643	23,50	79-06618	16,20
425	Magnum 425 2x4	1995-98	79-06643	23,50	79-06618	16,20
425	Magnum 425 4x4	1995-97	79-06604	18,20	79-06618	16,20
425	Magnum 425 4x4	1998	79-06604	18,20	79-06618	16,20
425	Xpedition 425	2000-01	79-06604	18,20		
425	Xpedition 425	2002	79-06604	18,20	79-06622	19,20
450	Outlaw 450	2008-10	79-06626	14,20	79-06648	44,00
450	Sportsman 450	2006-07	79-06622	19,20	79-06612	39,40
455	Diesel 455 4x4	1999-01	79-06604	18,20	79-06612	39,40
500	ATP 500 4X4	2004-05	79-06622	19,20	79-06622	19,20
500	ATV 500 Pro	2002	79-06622	19,20	79-06622	19,20
500	Magnum 500 2x4 HDS	2002	79-06643	23,50	79-06622	19,20
500	Magnum 500 4x4	1999-01	79-06604	18,20		
500	Magnum 500 4x4	2002	79-06622	19,20	79-06622	19,20
500	Magnum 500 4x4 HDS	2001-03	79-06622	19,20	79-06622	19,20
500	Outlaw 500	2006-07	79-06626	14,20	79-06622	19,20
500	Predator 500	2003	79-06626	14,20		
500	Predator 500	2004-07	79-06626	14,20	79-06648	44,00
500	PTV Series 10 4x4	2003	79-06622	19,20	79-06622	19,20
500	Scrambler 500 2x4	2000-02	79-06643	23,50	79-06613	19,20
500	Scrambler 500 2x4	2008	79-06626	14,20	79-06613	19,20
500	Scrambler 500 4x4	1997	79-06604	18,20	79-06618	16,20
500	Scrambler 500 4x4	1998-09	79-06604	18,20	79-06613	19,20
500	Scrambler 500 4x4	2010-12	79-06622	19,20	79-06613	19,20
500	Sportsman 500 4x4	1996-00	79-06604	18,20	79-06612	39,40
500	Sportsman 500 4x4 DUSE	2001-02	79-06604	18,20	79-06612	39,40
500	Sportsman 500 4x4 HO	2001-03	79-06604	18,20	79-06612	39,40
500	Sportsman 500 4x4 HO AA- AC- AE- AG	2004	79-06604	18,20	79-06612	39,40
500	Sportsman 500 4x4 HO AO - AX	2004	79-06622	19,20	79-06612	39,40
500	Sportsman 500 4x4 HO	2005-13	79-06622	19,20	79-06612	39,40
500	Sportsman 500 4x4 RSE	1999-02	79-06604	18,20	79-06612	39,40
500	Sportsman 500 EFI	2009-10	79-06622	19,20	79-06612	39,40
500	Sportsman 500 X2	2006-09	79-06622	19,20	79-06612	39,40
500	Sportsman Forest 500	2011-13	79-06622	19,20	79-06612	39,40
500	Sportsman Forest Tractor 500	2011-12	79-06622	19,20	79-06612	39,40
500	Sportsman Touring 500 EFI	2008-12	79-06622	19,20	79-06612	39,40
500	Sportsman Touring 500 HO	2013	79-06622	19,20	79-06612	39,40
500	Worker 500 4x4	1999-02	79-06604	18,20	79-06612	39,40
500	Xplorer 500	1997	79-06604	18,20	79-06612	39,40
525	Outlaw 525 IRS	2007-11	79-06626	14,20	79-06622	19,20
525	Outlaw 525 S	2008-10	79-06626	14,20	79-06648	44,00
550	Sportsman 550 EPS	2010-13	79-06657	35,30	79-06657	35,30
550	Sportsman 550 X2	2010-13	79-06657	35,30	79-06657	35,30
550	Sportsman 550	2011-13	79-06657	35,30	79-06657	35,30
550	Sportsman Forest 550	2011-13	79-06657	35,30	79-06657	35,30
550	Sportsman Touring EPS 550	2011-13	79-06657	35,30	79-06657	35,30
550	XP 550	2009	79-06657	35,30	79-06657	35,30
600	Sportsman 600 4x4	2003-05	79-06622	19,20	79-06612	39,40
700	Sportsman 700 4x4	2002-07	79-06622	19,20	79-06612	39,40
700	Sportsman 700 Twin EFI	2005-07	79-06622	19,20	79-06612	39,40
700	Sportsman MV7	2005	79-06622	19,20	79-06612	39,40
700	Sportsman X2 700 Twin EFI	2008	79-06622	19,20	79-06612	39,40
800	Sportsman 800 EFI	2005-12	79-06622	19,20	79-06612	39,40
800	Sportsman Forest 800 EFI	2012-13	79-06622	19,20	79-06612	39,40
800	Sportsman Touring 800 EFI	2008-09	79-06622	19,20	79-06612	39,40

Polaris						
CC	Malli	Vuosim.	Eteen	Hinta	Taakse	Hinta
800	Sportsman X2 800 EFI	2007-09	79-06622	19,20	79-06612	39,40
850	Scrambler HO/ EPS 850	2013	79-06657	35,30	79-06657	35,30
850	Sportsman Forest 850	2011-13	79-06657	35,30	79-06657	35,30
850	Sportsman Touring EPS 850	2010-13	79-06657	35,30	79-06657	35,30
850	Sportsman Touring EPS 850 HO	2013	79-06657	35,30	79-06657	35,30
850	Sportsman X2 850	2011	79-06657	35,30	79-06657	35,30
850	Sportsman XP 850	2009-13	79-06657	35,30	79-06657	35,30
850	Sportsman XP 850 EPS	2010-12	79-06657	35,30	79-06657	35,30
850	Sportsman XP 850 HO EPS	2013	79-06657	35,30	79-06657	35,30
UTV						
250	Big Boss 250 4x6	1989-92	79-06643	23,50	79-06618	16,20
250	Big Boss 250 6x6	1991-93	79-06604	18,20	79-06618	16,20
300	Big Boss 300 6x6	1994	79-06604	18,20	79-06618	16,20
350	Big Boss 350L 6x6	1993	79-06604	18,20	79-06618	16,20
400	Big Boss 400L 6x6	1994	79-06604	18,20	79-06618	16,20
400	Big Boss 400L 6x6	1995	79-06604	18,20	79-06618	16,20
400	Big Boss 400L 6x6	1996-97	79-06604	18,20	79-06618	16,20
400	Magnum 400L 6x6	1996-97	79-06604	18,20	79-06618	16,20
400	Ranger 4x4 400	2010-13	79-06622	19,20	79-06612	39,40
500	Big Boss 500 6x6	1998-99	79-06604	18,20	79-06618	16,20
500	Big Boss 500 6x6	2000	79-06604	18,20	79-06613	19,20
500	Big Boss 500 6x6	2003	79-06604	18,20	79-06613	19,20
500	PTV Series 10 6X6	2003	79-06604	18,20	79-06613	19,20
500	Ranger 2x4 500	2008-09	79-06622	19,20	79-06612	39,40
500	Ranger 4x4 500	1999	79-06604	18,20		
500	Ranger 4x4 500	2005-08	79-06622	19,20	79-06612	39,40
500	Ranger 4x4 500	2009-10	79-06657	35,30	79-06612	39,40
500	Ranger 4x4 500/ Crew	2011-13	79-06622	19,20	79-06612	39,40
500	Ranger 6X6 500	2002	79-06604	18,20		
500	Ranger 6X6 500	2004	79-06622	19,20	79-06612	39,40
500	Sportsman 500 6x6	2000-08	79-06604	18,20	79-06613	19,20
570	RANGER RZR 570 EFI	2012-13	79-06657	35,30	79-06612	39,40
700	Ranger 4x4 700	2005-08	79-06622	19,20	79-06612	39,40
700	Ranger 4x4 700	2009	79-06657	35,30	79-06612	39,40
700	Ranger 6x6 700 EFI	2006-09	79-06622	19,20	79-06612	39,40
800	Ranger 4x4 800 EFI	2010-12	79-06657	35,30	79-06612	39,40
800	Ranger 4x4 800 EFI CREW	2010-12	79-06657	35,30	79-06612	39,40
800	RANGER 6X6 800	2010	79-06657	35,30	79-06612	39,40
800	RANGER 6X6 800	2012-13	79-06657	35,30	79-06612	39,40
800	RANGER RZR 4/ EPS RGE	2011	79-06657	35,30	79-06612	39,40
800	RANGER RZR S 800	2009			79-06612	39,40
800	RANGER RZR S 800	2010-12	79-06657	35,30	79-06612	39,40
800	RANGER XP 800	2012	79-06657	35,30	79-06612	39,40
800	RZR 800	2008-09			79-06612	39,40
800	RZR 800 Built 1/01/10 and after	2010	79-06657	35,30	79-06612	39,40
800	RZR 800 Built 12/31/09 and Before	2010			79-06612	39,40
800	RZR 800	2011-12	79-06657	35,30	79-06612	39,40
800	Sportsman 800 EFI 6x6	2009-12	79-06622	19,20	79-06612	39,40
800	Sportsman Forest 800 6x6	2013	79-06622	19,20	79-06612	39,40
900	Ranger 4x4 CREW DIESEL 900	2011	79-06657	35,30	79-06612	39,40
900	Ranger 4x4 DIESEL 900	2011-13	79-06657	35,30	79-06612	39,40
900	Ranger Diesel 900 Crew	2013	79-06657	35,30	79-06612	39,40
900	Ranger RZR 4 XP 900	2013	79-06657	35,30	79-06657	35,30
900	Ranger RZR XP 900	2011-13	79-06657	35,30	79-06657	35,30



Vanteet ja renkaat



Talvituoitteet



Vinsit



Laukut ja tuulisuojat



Sähköosat



Jousitus ja voimansiirto



Pakoputket ja suutinsarjat



Ohjaus



Rungon osat ja peitteet



Jarrupalat ja rattaat



Moottori



Variaattorin osat



Maatalous-tarvikkeet



Kärtyt ja reet

ATV





PYÖRÄN LAAKERIT JATKUU



Vanteet ja renkaat



Talvituotteet



Vinssit



Laukut ja tuulisuojat



Sähköosat



Jousitus ja voimansiirto



Pakoputket ja suutinsarjat



Ohjauk



Rungon osat ja peitteet



Jarrupalat ja rattaat



Moottori



Variaattorin osat



Maatalous-tarvikkeet



Kärryt ja reet



ATV



ATV

Suzuki						
CC	Malli	Vuosim.	Eteen	Hinta	Taakse	Hinta
230	LT-230E	1987-93	79-06636	19,00	79-06620	17,20
230	LT-230S	1985-88	79-06636	19,00	79-06620	17,20
250	LT-250R	1985-92	79-06636	19,00	79-06620	17,20
250	LT-250S	1989-90	79-06636	19,00	79-06620	17,20
250	LT-4WD 250	1987	79-06610	14,20		
250	LT-4WD 250	1988-98	79-06610	14,20	79-06614	19,20
250	LT-F250	1988-01	79-06610	14,20	79-06614	19,20
250	LT-F250 Ozark	2002-12			79-06646	32,50
250	LT-F250F (Except Ozark)	1999-02	79-06610	14,20	79-06614	19,20
250	LT-F4WD 250	1997-98	79-06610	14,20	79-06614	19,20
250	LT-Z250	2004-09	79-06636	19,00	79-06646	32,50
300	LT-300E	1987-89			79-06620	17,20
300	LT-F300F King Quad	1999-02	79-06610	14,20	79-06614	19,20
300	LT-F4WDX King Quad 300	1991-98	79-06610	14,20	79-06614	19,20
400	LT-A400 2WD King Quad	2008-09	79-06610	14,20		
400	LT-A400 Eiger 2wd	2002-04	79-06610	14,20		
400	LT-A400 Eiger 2wd	2007	79-06610	14,20		
400	LT-A400F 4WD King Quad	2008-12	79-06610	14,20		
400	LT-A400F Eiger 4wd	2002-07	79-06610	14,20		
400	LT-F400 2WD King Quad	2008-09	79-06610	14,20		
400	LT-F400 Eiger 2wd	2002-04	79-06610	14,20		
400	LT-F400 Eiger 2wd	2007	79-06610	14,20		
400	LT-F400F 4WD King Quad	2008-12	79-06610	14,20		
400	LT-F400F Eiger 4wd	2002-07	79-06610	14,20		
400	LT-Z400	2003-08	79-06636	19,00	79-06620	17,20
400	LT-Z400	2009	79-06636	19,00	79-06647	23,50
450	LTA-450 X King Quad	2007-10	79-06666	22,00	79-06667	29,50
450	LT-R450	2006-11	79-06636	19,00	79-06651	27,50
500	LT-500R	1987-90	79-06636	19,00		
500	LT-A500F Quad Master Auto	2000-01	79-06610	14,20		
500	LT-A500F Vinson	2002-07	79-06610	14,20		
500	LT-A500X	2009-13	79-06666	22,00	79-06667	29,50
500	LT-F500F	1998-99	79-06610	14,20		
500	LT-F500F	2000-02	79-06610	14,20		
500	LT-F500F Vinson	2003-07	79-06610	14,20		
700	LTA-700 X King Quad	2005-07	79-06666	22,00	79-06667	29,50
700	LTV-700F Twin Peaks	2004-06	79-06627	21,20		
750	LTA-750 X King Quad	2008-13	79-06666	22,00	79-06667	29,50

Yamaha						
CC	Malli	Vuosim.	Eteen	Hinta	Taakse	Hinta
125	YFM125 Raptor	2011-13	79-06635	20,00	79-06650	19,00
200	YFS200 Blaster	1988-02	79-06655	16,50		
200	YFS200 Blaster	2003-06	79-06635	20,00	79-06615	18,50
250	YFB250 Timberwolf	1992-94	79-06655	16,50		
250	YFB250 Timberwolf	1995-98	79-06635	20,00		
250	YFB250FW Timberwolf	1994	79-06610	14,20		
250	YFB250FW Timberwolf	1995-00	79-06610	14,20		
250	YFM 250 Raptor	2008-13	79-06635	20,00	79-06650	19,00
250	YFM250 Beart-racker	1999			79-06607	30,00
250	YFM250 Moto-4	1989-91	79-06635	20,00		
250	YTZ250 Tri Moto	1985-86				
250	YFM250 Beart-racker	2000-04			79-06668	29,50
250	YFM250 Big Bear	2007-09			79-06668	29,50
250	YFM250B Bruin	2005-06			79-06668	29,50
350	YFM350 Grizzly 4WD	2013			79-06668	29,50

Suzuki						
CC	Malli	Vuosim.	Eteen	Hinta	Taakse	Hinta
350	YFM350 Grizzly IRS	2007-11	79-06610	14,20	79-06624	18,20
350	YFM350 Raptor	2004-13	79-06635	20,00	79-06650	19,00
350	YFM350 Warrior	1987-04	79-06635	20,00	79-06619	
350	YFM350ER Moto-4	1990-95	79-06635	20,00		
350	YFM350FW Big Bear	1987-95	79-06610	14,20		
350	YFM350FW Big Bear	1996-99	79-06610	14,20	79-06607	30,00
350	YFM350U Big Bear	1996-99	79-06610	14,20	79-06607	30,00
350	YFM35FX Wol-verine	1995-99	79-06610	14,20		
350	YFM35FX Wol-verine	2000-05	79-06610	14,20		
350	YFZ350 Banshee	1987-88	79-06635	20,00		
350	YFZ350 Banshee	1989-06	79-06635	20,00	79-06615	18,50
350	YFM350 Bruin 2WD	2004-06			79-06668	29,50
350	YFM350FA Bruin 4WD	2004-06			79-06668	29,50
350	YFM350FGW Grizzly 4WD	2007-13			79-06668	29,50
350	YFM350GW Griz-zly 2WD	2007-11			79-06668	29,50
350	YFM350X Wol-verine	2006-09			79-06668	29,50
400	YFM400 Big Bear IRS	2007-12	79-06610	14,20	79-06624	18,20
400	YFM400 Grizzly IRS	2007-08	79-06610	14,20	79-06624	18,20
400	YFM400 Kodiak 2WD	2000-01	79-06610	14,20	79-06606	26,50
400	YFM400 Kodiak 4WD	1993-99	79-06610	14,20	79-06608	31,50
400	YFM400 Kodiak 4WD	2000-02	79-06610	14,20	79-06606	26,50
400	YFM400 Kodiak 4WD	2005-06	79-06610	14,20	79-06624	18,20
400	YFM400 Big Bear 2WD	2000-04			79-06668	29,50
400	YFM400 Big Bear 4WD	2000-06			79-06668	29,50
400	YFM400 Kodiak 2WD	2003-04			79-06668	29,50
400	YFM400 Kodiak 4WD	2003-04			79-06668	29,50
450	YFM450 Grizzly EPS	2013	79-06610	14,20	79-06624	18,20
450	YFM450 Grizzly IRS	2007-13	79-06610	14,20	79-06624	18,20
450	YFM450 Kodiak	2003-04	79-06610	14,20	79-06606	26,50
450	YFM450 Kodiak	2005-06	79-06610	14,20	79-06624	18,20
450	YFM45FX Wol-verine 450 4X4	2006-10	79-06610	14,20		
450	YFZ450	2004-05	79-06635	20,00		
450	YFZ450	2006-09	79-06635	20,00	79-06639	48,00
450	YFZ450	2012-13	79-06635	20,00		
450	YFZ450R	2009-13	79-06635	20,00		
450	YFZ450X	2010-11	79-06635	20,00		
550	YFM550 Grizzly/ EPS	2009-13	79-06624	18,20	79-06624	18,20
600	YFM600 Grizzly	1998	79-06610	14,20	79-06607	30,00
600	YFM600 Grizzly	2002	79-06621	17,00	79-06625	25,00
600	YFM600 Grizzly	1999-01			79-06668	29,50
660	YFM660 Grizzly	2002	79-06621	17,00	79-06625	25,00
660	YFM660 Grizzly	2003-08	79-06624	18,20	79-06624	18,20
660	YFM660R Raptor	2001-05	79-06635	20,00	79-06615	18,50
700	YFM700 Grizzly	2007-13	79-06624	18,20	79-06624	18,20
700	YFM700 Grizzly EPS	2008-13	79-06624	18,20	79-06624	18,20
700	YFM700R Raptor	2006-12	79-06635	20,00	79-06639	48,00
700	YFM700R Raptor	2013	79-06635	20,00		
UTV						
450	450RHINO	2006-09	79-06610	14,20	79-06632	17,50
660	660 RHINO	2004-07	79-06610	14,20	79-06632	17,50
700	700 RHINO FI	2008-13	79-06610	14,20	79-06632	17,50

TAKA-AKSELIT



HONDA		
TRX 300	1988-99	
TAKA AKSELI 46x828mm	78-08250	141,30
SUPER STRONG		
CHROMOLY 4140		
TRX 450	2004-05	
TAKA AKSELI 890mm	78-08260	199,30
SUPER STRONG		
SCM 440		
TRX 420	2007-09	
TAKA AKSELI 856mm	78-08251	151,50
SUPER STRONG		
SMC 440		
TRX 350,400 RANCHER	2004-06	
TAKA AKSELI 34x834mm	78-08252	131,10
SUPER STRONG		
SMC 440		
TRX 500 FOREMAN,RUBICON	2001-09	
TAKA AKSELI 34x932mm	78-08254	141,30
SUPER STRONG		
SMC 440		

SUZUKI/KAWASAKI/ARCTIC CAT		
A-C DVX 400	2003-07	
KAW KFX 400	2003-07	
SUZ LTZ 400	2003-07	
TAKA AKSELI 920mm	78-08259	241,90
SUPER STRONG		
SMC 440		

YAMAHA		
RAPTOR 660	2002-05	
TAKA AKSELI 865mm	78-08261	144,30
SUPER STRONG		
SCM 440		
TAKA AKSELI 916mm	78-08261-1	159,50
(Korvaa Alkup.nr 5LP-25381-00)		
SUPER STRONG		
SCM 440		
YFM 350 WARRIOR	1986-03	
TAKA AKSELI	78-08257	171,70
YFZ 350 BANSHEE		
TAKA AKSELI 35x924mm	78-08253	159,50
(Korvaa Alkup.nr 38W-25831-02-00)		
SUPER STRONG		
SNCM439 HARDNESS HRC30-35		
YFZ 450		
TAKA AKSELI 920mm	78-08262	156,50
SUPER STRONG		
SMC 440		
TAKA AKSELI 971mm	78-08262-1	168,70
SUPER STRONG		
SMC 440		



STRAIGHTLINE PERFORMANCE



Suosittellemme, että säädätät mönkijäsi Powercommanderilla suorituskvyn optimoimiseksi.



MADE IN U.S.A.

Straightline Performance (SPI) on yhdysvaltalainen vitytosia valmistava yritys. SPI:llä on yli 40 vuoden kokemus pakoputkien ja muiden vitytosien valmistuksesta. Kaikki tuotteet valmistetaan Yhdysvalloissa.

Straightline Performance ATV Slip-On Pakoputkistot antaa enemmän voimaa ja hienon äänen.

uutuus!

Putket

Can-Am				
Tuotennr	Hinta	Tuotekuvaus	Materiaali	Lisää hevosvoimia
721-242-116	465,00 €	SPI Slip-On Exhaust Can-Am Outlander XT 2008-12	Keraaminen/Alumiini	4 hv
721-242-117	465,00 €	SPI Slip-On Exhaust Can-Am Outlander MAX 2008-12	Keraaminen/Alumiini	4 hv
721-242-118	465,00 €	SPI Slip-On Exhaust Can-Am Renegade 500/800 2008-12	Keraaminen/Alumiini	4 hv
721-242-119	465,00 €	SPI Slip-On Exhaust Can-Am Outlander 500/650/800/1000 Gen 2	Keraaminen/Alumiini	4 hv
Suzuki				
Tuotennr	Hinta	Tuotekuvaus	Materiaali	Lisää hevosvoimia
721-244-101	465,00 €	SPI Slip-On Exhaust Suzuki King Quad 750 2008-	Keraaminen/Alumiini	2 hv
Yamaha				
Tuotennr	Hinta	Tuotekuvaus	Materiaali	Lisää hevosvoimia
721-246-101	465,00 €	SPI Slip-On Exhaust Yamaha Grizzly 700 08-13	Keraaminen/Alumiini	2 hv



Tarvikkeet

Tuotennr	Hinta	Tuotekuvaus	Materiaali
721-248-100	35,00 €	SPI DB Killer / Kipinä verkko	Ruostumaton teräs
821-131-154	254,00 €	2012-14 800 F/XF/M Y-Putki	



ATV





Vanteet ja renkaat



Talvituotteet



Vinssit



Laukut ja tuulisuojat



Sähköosat



Jousitus ja voimansiirto



Pakoputket ja suutinsarjat



Ohjaus



Rungon osat ja peitteet



Jarrupalat ja rattaat



Moottori



Variaattorin osat



Maatalous-tarvikkeet



Kärryt ja reet

YOSHIMURA®

SLIP-ON JA TÄYDELLISET PUTKISTOT

Yoshimura, Committed to Racing, kuvaa yrityksen asennetta tuotekehitykseen. ATV-alalla kehitys on ollut nopeaa ja Yoshimura kulkee tässäkin muita edellä hyödyntäen kilpapakenttien kokemustaan siirtäessään osaamistaan myös ATV-puolelle.



SLIP-ON & PUTKISTOT

Vaimentimet ja putkistot ruostumatonta terästä. RS-3:ssa on ovaalinmuotoinen vaimennin, RS-2 ja TRC:ssa kolmionmuotoinen. RS-5 ja Oval-Cone ovat mallit joka ovat keskellä penkin alla, ja trapetsinmuodoiset läpileikkaukseltaan.

ARCTIC CAT				
Til.no.		vm	Tyyppi	Hinta
31-2175500	DVX400		RS-3 FULL SYSTEM, SS/SS	620,-
BOMBARDIER / CAN-AM				
Til.no.		vm	Tyyppi	Hinta
31-2515503	DS450	08-09	RS-2 FULL SYSTEM, SS/ALU	740,-
HONDA				
Til.no.			Tyyppi	Hinta
31-2270703	TRX400X/EX	99-13	RS-2 S-O, SS/ALU	
31-324200C550	TRX420 Rancher	14	RS-2 FULL SYSTEM, SS/ALU	
31-2276513	TRX450R/ER	06-14	RS-2 FULL SYSTEM, SS/ALU	696,-
31-324200C550	TRX500 Rancher	14	RS-2 FULL SYSTEM, SS/ALU	
31-2260703	TRX700	08-	RS-2 S-O, SS/ALU	510,-
KAWASAKI				
Til.no.			Tyyppi	Hinta
31-2175500	KFX400	03-12	RS-3 FULL SYSTEM, SS/SS	390,-
POLARIS				
Til.no.			Tyyppi	Hinta
31-2530503	OUTLAW 450MXR	07-09	RS-5 FULL SYSTEM, SS/ALU	640,-
31-2550600	PREDATOR RS3 SO/SS/SS	03-07	RS-3 S-O, SS/SS	439,-
31-2545503	OUTLAW 525 S	07-10	RS-5 FULL SYSTEM, SS/ALU	690,-
SUZUKI				
Til.no.			Tyyppi	Hinta
31-2175500	LT-Z	03-12	RS-3 FULL SYSTEM, SS/SS	390,-
31-3115007351	LTR450	06-10	RS-5 FULL SYSTEM, SS/ALU	740,-
31-2110600	KING QUAD 500	kaikki	TRS S-O, SS/SS	290,-
31-2110600	KING QUAD 700	kaikki	TRS S-O, SS/SS	290,-
31-2110600	KING QUAD 750	kaikki	TRS S-O, SS/SS	290,-
YAMAHA				
Til.no.			Tyyppi	Hinta
31-2390703	RAPTOR 350	04-13	RS-2 S-O, SS/ALU	290,-
31-2375713	YFZ450	04-09	RS-2 S-O, SS/ALU	510,-
31-2376513	YFZ450R	09-14	RS-2 FULL SYSTEM, SS/ALU	648,-
31-2388513	RAPTOR 700 RS2/SS/ALU	06-14	RS-2 FULL SYSTEM, SS/ALU	790,-
31-2388713	RAPTOR 700 RS7/SO/ALU	06-14	RS-2 S-O, SS/ALU	520,-

DESIBELI-KILLERIT

Alla olevasta taulukosta näet minkätyyppisiä dB-killereitä on saatavilla pyöräsi. Spark Arrester Kiteissä on metalliverkkoa, 94dB killereissä ainoastaan suoraa putkea. Muista myös pitää villasi tuoreena ja sopivasti pakattuna.

Can-Am	Tyyppi	96dBA Spark Arrester Kit	94dBA Insert Kit
DS 450	RS2	31-SA-02-K	31-INS-11-K
Outlaw 525/IRS	RS5	31-SA-05-K	
Honda			
TRX 400/700	RS2	31-SA-03-K	
TRX 450R	RS2	31-SA-06-K	
Kawasaki			
KFX 450	RS2	31-SA-07-K	31-INS-11-K
KFX 700	RS2	31-SA-03-K	
Suzuki			
LT-Z 400	RS2	SA-02-K	
Yamaha			
Raptor 350	RS2	31-SA-03-K	
YFZ 450	RS2	31-SA-07-K	31-INS-11-K
YFZ 450 R	RS2	31-SA-03-K	31-INS-12-K
Raptor 700	RS2	31-SA-07-K	
Raptor 700	RS2	31-SA-07-K	

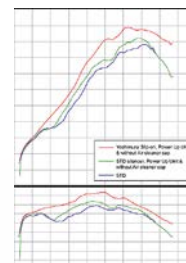

YOSHIMURA Power-Up unit SUZUKI LT-R 450

Sallii koneen kiertää 10,200 rpm ja muuttaa ECU-boxin fuel-mapia (polttoainekartta).

Tuotenumero	Hinta
31J-446-180-0000	59,-



G.P.R. PAKOPUTKET



Italialaiset G.P.R. vaimentimet on valmistettu 304 luokan ruostottomasta teräksestä ja erikoisalumiinista. Erinomainen sopivuus ja kestävä rakenne. Nyt saatavilla myös E-hyväksytyt versiot jos haluat ns. tieliikenneversion.

Joko Slip-On, eli vaimennin ja väliputki tai täydelliset putkistot tiettyihin malleihin.

CAN-AM	Kuori	tyyppi	Til. nro RACING	Ovh.	Til. nro E-hyväksytyt	Ovh.
OUTLANDER 800XT	DEEPTONE Rosteri	SLIP ON			31G-QUSP145-E	635,-
OUTLANDER 1000 13-	DEEPTONE Rosteri	SLIP ON			31G-QUSP160-E	635,-
KAWASAKI	Kuori	tyyppi	Til. nro RACING	Ovh.	Til. nro E-hyväksytyt	Ovh.
KFX 400	ALU/OVAALI	SLIP ON	31G-QUSP33	416,-		
KYMCO	Kuori	tyyppi	Til. nro RACING	Ovh.	Til. nro E-hyväksytyt	Ovh.
KRX 250	ALU/OVAALI	FULL SYSTEM	31G-QUSP7	416,-		
MXU 250	ALU/OVAALI	FULL SYSTEM	31G-QUSP39	416,-		
POLARIS	Kuori	tyyppi	Til. nro RACING	Ovh.	Til. nro E-hyväksytyt	Ovh.
TRAIL BOSS 330	ALU/OVAALI	SLIP ON	31G-QUSP11	372,-		
SPORTSMAN 500	DEEPTONE Rosteri	SLIP ON			31G-QUSP5-E	429,-
PREDATOR 500	ALU/OVAALI	SLIP ON			31G-QUSP13-E	425,-
SCRAMBLER	ALU/OVAALI	SLIP ON	31G-QUSP58	372,-	31G-QUSP58-E	393,-
SPORTSMAN 700	ALU/OVAALI	SLIP ON			31G-QUSP1-E	429,-
SPORTSMAN 800	DEEPTONE Rosteri	SLIP ON			31G-QUSP147-E	429,-
XP 850	DEEPTONE Rosteri	SLIP ON			31G-QUSP150-E	479,-
SUZUKI	Kuori	tyyppi	Til. nro RACING	Ovh.	Til. nro E-hyväksytyt	Ovh.
LTZ 400	ALU/OVAALI	SLIP ON	31G-QUSP15	429,-		
TGB	Kuori	tyyppi	Til. nro RACING	Ovh.	Til. nro E-hyväksytyt	Ovh.
TARGET 425	SS/POWERCONE	FULL SYSTEM	31G-QUSP125	731,-		
TARGET 525	SS/POWERCONE	FULL SYSTEM			31G-QUSP126-E	767,-
BLADE	THUNDER	S-O TUPLA			31G-QUSP136-E	717,-
YAMAHA	Kuori	tyyppi	Til. nro RACING	Ovh.	Til. nro E-hyväksytyt	Ovh.
RAPTOR 660	ALU/OVAALI	SLIP ON	31G-QUSP37	359,-		
RAPTOR 700	DEEPTONE Rosteri	SLIP ON	31G-QUSP116	429,-		



Vanteet ja renkaat



Talvituotteet



Vinsit



Laukut ja tuulisuojat



Sähköosat



Jousitus ja voimansiirto



Pakoputket ja suutinsarjat



Ohjauksen osat



Runnon osat ja peitteet



Jarrupalat ja rattaat



Moottori



Variaattorin osat



Maatalous-tarvikkeet



Kärryt ja reet



MUISTA VAIHTAA VILLAT SÄÄNNÖLLISESTI!

Sillä tavalla et hävitä hevosvoimia turhaan, äänitaso pysyy tarkoitetulla tasolla ja kuoren elinikä pitenee.

Varavilla

Yoshimuran pitkäsaikeinen vaimenninvilla on pitkäikäistä ja kestävä.

Tuoteno	Hinta
31-PACKING1	22,-

G.P.R. -putkisto ja Polaris Predator 500





Vanteet ja renkaat



Talvituotteet



Vinssit



Laukut ja tuulisuojat



Sähköosat



Jousitus ja voimansiirto



Pakoputket ja suutinsarjat



Ohjaus



Rungon osat ja peitteet



Jarrupalat ja rattaat



Moottori



Variaattorin osat



Maatalous-tarvikkeet



Kärryt ja reet

ATV



Dynojet

POWER COMMANDER V

POWERCOMMANDER

Power Commander antaa täydelliset ruiskutuksen säätömahdollisuudet! Se on kevyt, pienikokoinen ja täysin suojattu microprosessori, joka kytketään suoraan suoraruiskutuksella varustetun ATV:n omaan johtosarjaan. Säädöt tapahtuvat joko etupanelissa olevien nappien avulla tai PC:n USB liitännän kautta. Suositustaulukko alla.



MERKKI / MALLI	VM	PCIII USB	PCV	OSH
Arctic Cat				
450H1	2010-2012		242-11-008	374
450/500 mallit	2013		242-11-016	374
450/500 mallit	2014		242-11-018	374
550H1	2009-2014		242-11-005	374
Prowler	2008	241-623-411		363
700 EFI Quad	2006-2007	241-616-411		363
700 H1	2008	241-630-411		363
700 H1	2009-2012		242-11-006	374
700 mallit	2013		242-11-014	374
700 mallit	2014		242-11-020	374
Thundercat 1000	2008	241-622-411		363
Thundercat 1000	2008-2013		242-11-002	374
Thundercat 1000 FUEL & IGNITION	2008-2013		242-11-011	399,00
Prowler 1000	2008-2013		242-11-001	374
Wildcat 1000	2012-2014		242-11-010	374
TRV/Mudpro	2010-2014		242-11-017	
Bombardier				
Outlander 400	2009-2014		242-25-005	374
DS450	2008-2014		242-25-001	374
Outlander 500	2007-2008	241-618-411		363
Outlander 500	2007-2011		242-25-012	374
Outlander 500	2013-2014		242-25-019	374
Outlander 650	2006-2008	241-620-411		363
Outlander 650	2006-2014		242-25-013	374

MERKKI / MALLI	VM	PCIII USB	PCV	OSH
Bombardier				
Outlander 800	2006-2008	241-615-411		363
Outlander 800/1000	2012-2014		242-25-009	374
Renegade 800	2007-2008	241-621-411		363
Renegade 800	2007-2011		242-25-003	374
Renegade 500/800/1000	2012-2014		242-25-014	374
Commander 800 FUEL & IGNITION	2011-2014		242-25-007	399,00
CanAm Spyder	2009-2012		242-25-004	399,00
CanAm Spyder RT/RTS	2010-2013		242-25-006	403
Commander 1000 FUEL & IGNITION	2011-2014		242-25-008	399,00
Maverick	2013-20147		242-25-016	
Honda				
Rancher	2007-2008	241-128-411		363
Rancher 420	2009-2013		242-16-018	374
TRX500 Foreman FUEL & IGNITION	2012-2014		242-16-028	374
Rincon	2006-2008	241-124-411		363
Rincon	2006-2014		242-16-019	374
TRX700XX	2008-2009		242-16-004	374
Kawasaki				
KFX450 FUEL & IGNITION	2008-2014		242-17-036	399,00

POWERCOMMANDER JATKUU

MERKKI / MALLI	VM	PCIII USB	PCV	OSH
Kawasaki				
Brute Force 750	2008	241-232-411		363
Brute Force 750	2008-2011		242-17-019	374
Brute Force 750 FUEL & IGNITION	2008-2011		242-17-031	399,00
Brute Force 750 FUEL & IGNITION	2012-2014		242-17-039	399,00
Polaris				
Sportsman 550 FUEL & IGNITION	2009-2014		242-19-016	399,00
Sportsman 570 FUEL & IGNITION	2014		242-19-022	
RZR 570 FUEL & IGNITION	2012-2014		242-19-015	374
700 Twin EFI	2004	241-910-411		363
700 Twin EFI	2005-2008	241-911-411		363
Ranger XP	2006-2008	241-924-411		363
Ranger RZR / S	2008	241-930-411		363
Ranger RZR / S FUEL & IGNITION	2008-2010		242-19-013	399,00
Ranger RZR / S / 4 FUEL & IGNITION	2011-2014		242-19-011	399,00
Ranger 800 FUEL&IGNITION	2013-2014		242-19-025	
Sportsman 800	2005-2008	241-912-411		363
Sportsman 800	2009-2014		242-19-008	374
Sportsman 850	2009-2012		242-19-005	374
Sportsman 850 FUEL & IGNITION	2009-2011		242-19-014	399,00
Sportsman 850 FUEL & IGNITION	2012		242-19-018	399,00
Scrambler 850	2013-2014		242-19-019	399,00
RZR XP900 FUEL & IGNITION	2011-2012		242-19-012	399,00
Suzuki				
Ltz400	2009-2012		242-20-002	374
Ltr450	2006-2010		242-20-019	374
KingQuad 400 FUEL & IGNITION	2011-2014		242-20-026	399
KingQuad 450	2007-2008	241-335-411		363
KingQuad 500	2011-2014		242-20-027	374
KingQuad 700 EFI	2005-2007	241-321-411		363
KingQuad 750	2008	241-347-411		363
KingQuad 750	2010-2014		242-20-031	374
Yamaha				
Yfz450 R / X FUEL & IGNITION	2009-2014		242-22-044	399,00
Grizzly 550	2009-2014		242-22-033	374
Raptor FUEL & IGNITION	2006-2014		242-22-046	399,00
Grizzly 700	2007-2008	241-425-411		363
Grizzly 700	2009-2014		242-22-027	374
Rhino 700	2008	241-434-411		363
Rhino 700	2009-2013		242-22-004	374
Rhino 700 FUEL & IGNITION	2008-2013		242-22-047	399,00

Universal Off-Road Quickshifter

Yleismallinen quickshifteri joka kytketään sytytyspuolelle. Täydellinen sarja jossa lineaarinen katkaisija joka asennetaan vaihdevivun ja esim. Rungon välille.

TIL.NO	OSH
24-4-119	439,-



Dynojet

SUUTINSARJAT

tarjoavat sinulle yksinkertaisen ja edullisen ratkaisun kaasutinsäätöihin. Dynojetin suutinsarjat nostavat tehoa koko kierrosalueella, säilyttäen polttoainekulutuksen normaalitasolla. Sarjat sisältävät täydelliset asennusohjeet "step-by-step" sekä säätöohjeet. Varastoimme laajan valikoiman, joka takaa nopean toimituksen jälleenmyyjämme kautta. Suositustaulukko alla.

ARCTIC-CAT	VM	TUOTENRO.	HINTA
400 DVX	2004	240-Q627	59,-
400 DVX	05-06	240-Q628	59,-
400 4x4 AUTO	03-08	240-Q622	59,-
500 AC AUTO	03-08	240-Q621	59,-
650	04-05	240-Q626	59,-
650 H1	05-08	240-Q629	59,-

BOMBARDIER	VM	TUOTENRO.	HINTA
OUTLANDER 400	04-08	240-Q710	59,-
OUTLANDER MAX 400	04-08	240-Q711	59,-
DS 650	00-07	240-Q702	59,-

HONDA	VM	TUOTENRO.	HINTA
TRX 350	00-06	240-Q108	
TRX 450 R	04-05	240-Q113	59,-
TRX 450 R	06-08	240-Q118	59,-
TRX 500 RUBICON	00-05	240-Q109	59,-
TRX 500 RUBICON	06-08	240-Q116	59,-
TRX 500 FOREMAN/4x4/ES	05-08	240-Q115	59,-
TRX 650 RINCON	03-05	240-Q112	59,-

KAWASAKI	VM	TUOTENRO.	HINTA
KFX 400	03-04	240-Q213	59,-
KFX 400	05-06	240-Q218	59,-
KFX 700	03-08	240-Q214	92,-
KVF 750 BRUTE FORCE	05-07	240-Q217	92,-

KTM	VM	TUOTENRO.	HINTA
450XC	08-09	240-Q901	59,-
450SX	09-10	240-Q903	59,-
505SX	09-10	240-Q904	59,-
525XC	08-10	240-Q902	59,-

POLARIS	VM	TUOTENRO.	HINTA
200 SAWTOOTH	06-08	240-Q520	59,-
200 PHOENIX	05-06	240-Q521	59,-
300 SPORTSMAN	08-10	240-Q528	59,-
330 TRAIL BOSS	03-06	240-Q516	59,-
330 MAGNUM	03-06	240-Q517	59,-
400 SPORTSMAN	01-05	240-Q514	59,-
400 SPORTSMAN	06-07	240-Q524	59,-
400 SPORTSMAN	08-10	240-Q529	59,-
450 MXR	08-10	240-Q530	59,-
500 SPORTSMAN H.O.	01-06	240-Q513	59,-
500 SCRAMBLER	98-06	240-Q504	59,-
500 PREDATOR	03-07	240-Q518	59,-
500 OUTLAW	06-07	240-Q523	59,-
525 OUTLAW	07-	240-Q525	59,-
600 TWIN SPORTSMAN	03-05	240-Q519	59,-
700 TWIN SPORTSMAN	02-06	240-Q515	59,-

SUZUKI	VM	TUOTENRO.	HINTA
LT-Z 400	03-04	240-Q312	59,-
LT-Z 400	05-08	240-Q316	59,-
VINSON 500 4x4	02-07	240-Q311	59,-
LT-V 700 F	04-05	240-Q315	92,-

YAMAHA	VM	TUOTENRO.	HINTA
GRIZZLY 350	07-	240-Q431	59,-
YFM 350 RAPTOR	04-08	240-Q423	59,-
YFM 400 KODIAK	00-06	240-Q412	59,-
WOLVERINE 450	06-	240-Q426	59,-
YFM 450 KODIAK	03-06	240-Q420	59,-
YFZ 450	04-05	240-Q421	59,-
YFZ 450	06-08	240-Q427	59,-
YFM 660 GRIZZLY	02-08	240-Q415	59,-
YFM 660 RAPTOR	01-05	240-Q414	92,-



Vanteet ja renkaat



Talvituotteet



Vinsit



Laukut ja tuulisuojat



Sähköosat



Jousitus ja voimansiirto



Pakoputket ja suutinsarjat



Ohjaus



Rungon osat ja peitteet



Jarrupalat ja rattaat



Moottori



Variaattorin osat



Maatalous-tarvikkeet



Kärryt ja reet

ATV





MITTARIT DAYTONA®



Vanteet ja renkaat



Talvituet



Vinssit



Laukut ja tuulisuojat



Sähköosat



Jousitus ja voimansiirto



Pakoputket ja suutinsarjat



Ohjaus



Rungon osat ja peitteet



Jarrupalat ja rattaat



Moottori



Variaattorin osat



Maatalous-tarvikkeet



Kärryt ja reet

uutuus!



Velona Nopeusmittari 200km/h 60mm

Velona nopeusmittari toimii moottoripyörissä yms. joissa vakiona sähköinen nopeusanturi. Lisävarusteena saatavana optinen anturi (t.no.29-8065) jolla toimii myös laitteissa joissa ei ole sähköistä nopeusanturia. Pienen kokonsa (halk.60mm) ja mukana tulevan kiinnikkeen ansiosta helppo asentaa pieneenkin tilaan.

Ominaisuudet:

- Nopeus 0-200 km/h
- Jännite
- Kilometrit
- 2 trippimittaria

Tuoteno	Hinta
290-8051	99,90

uutuus!



Velona Digital 0-399km/h 60mm

- Nopeusmittari 0-399km/h tai 0-250MPH
- Matkamittari 0-99999km/Mailia
- 2 nollattavaa trippimittaria
- Kierroslukumittari 0-20 000RPM
- grafiikkaa pystyy muokkaamaan
- Lcd näyttö: Valkoinen grafiikka / musta tausta
- Taustavalo: Valk. led
- Jännite: DC8-16V
- 2 ohjauspainiketta mittarin takana
- Yhteensopiva 290-8060 ja 290-8061 kauko-ohjaimien kanssa
- Ei sis.nopeusanturia
- Liitetään moottoripyörässä olevaan anturiin tai käytetään lisävarusteena saatavaa 29-8065 anturia

Tuoteno	Hinta
290-8052	99,90

uutuus!



Velona Kierrosl.mittari 0-18000r/pm 60mm

- Kierroslukumittari ominaisuudet:
- Asteikko 0-18000r/pm
- Muistaa Max kierroluvun
- Lämpömittari (tarvitsee erillisen anturin)
- Muistaa max lämpötilan
- Kello
- Nollattava tuntimittari 0 - 9999 tuntia
- Halkaisija 60mm
- Syvyys 48mm
- Vesitiivis
- Mukana V-kiinnike

Tuoteno	Hinta
290-8053	99,90

uutuus!



Velona Kierrosl.mittari 0-8000r/pm 60mm

- Kierroslukumittari ominaisuudet:
- Asteikko 0-8000r/pm
- Muistaa Max kierroluvun
- Lämpömittari (tarvitsee erillisen anturin)
- Muistaa max lämpötilan
- Kello
- Nollattava tuntimittari 0 - 9999 tuntia

- Halkaisija 60mm, syvyys 48mm
- Vesitiivis
- Mukana V-kiinnike

Tuoteno	Hinta
290-8054	99,90

uutuus!



Velona kauko-ohjain kromi

Tuoteno	Hinta
290-8060	49,00

uutuus!



Velona kauko-ohjain musta

Tuoteno	Hinta
290-8061	49,00

uutuus!



Daytona 12V5A USB-pistorasia

Kompaktin kokoinen USB-lataus-pistorasia

Tuoteno	Hinta
290-8100	27,00

uutuus!



Daytona 12V5A USB- & tupakansytytin-pistorasia

Kompaktin kokoinen USB- & tupakansytytin-pistorasia.

Tuoteno	Hinta
290-8101	30,50

ATV

Daytona Nano II nopeusmittari

- 0-399km/h
- Matkamittari:0-999999km
- 2xTriippi:0-999999km
- Huippunopeusmuisti
- Valinnainen näytön päivitysnopeus (0.16/0.5sec)
- Magn.anturi tulee mukana
- Voidaan liittää myös (oem) sähköiseen nopeusanturiin
- Kello 24h
- Taustavalaistu (valk. Led)
- Kiinnike ohjaustankoon 7/8 & 1" mukana
- Toimii myös 9V PP3 paristolla
- Mitat: 40x60x17.5mm



Tuoteno	Tuote	Hinta
29-8026	Daytona Nano II Nopeusmittari	105,90

Muut Daytona Nano-mittarit

Tuoteno	Tuote	Hinta
29-8020	Nano Tunti/kierrosmittari+kello	49,40
29-8021	Nano Nopeusmittari+kello	52,50
29-8022	Nano Lämpömittari+kello	57,50
29-8026	Nano II nopeusmittari	105,90



Tarvikkeet

Tuoteno	Tuote	Hinta
29-8010	Asura/Nano Mittarin Lämpöanturi+johdo R1/8	19,80
29-8065	Asura/Nano/Velona nopeusanturi (optinen anturi)	36,30
29-8066-1	Öljyproppu+tiiv. M12XP1.5 - R1/8 anturille Asura/Nano	11,10
29-8066-2	Öljyproppu+tiiv. M14XP1.25 - R1/8 anturille Asura/Nano	11,10
29-8066-3	Öljyproppu+tiiv. M14XP1.5 - R1/8 anturille Asura/Nano	11,10
29-8066-4	Öljyproppu+tiiv. M16XP1.5 - R1/8 anturille Asura/Nano	11,10
29-8066-5	Öljyproppu+tiiv. M18XP1.5 - R1/8 anturille Asura/Nano	11,10
29-8066-6	Öljyproppu+tiiv. M20XP1.0 - R1/8 anturille Asura/Nano	11,60
29-8066-7	Öljyproppu+tiiv. M20XP1.5 - R1/8 anturille Asura/Nano	11,60



ASURA monit.mittari

- Nopeusmittari 0-399km/h
- Kierroslukumittari 0-20000r/ pm
- Matkamittari
- 2- trippimittaria
- Kello
- Akkuvahti
- Huippunopeusmuisti
- Huippukierrosmuisti
- Lämpömittari*2 ilma&öljy
- Polttoainemittari
- Öljynvaihto muisti
- Merkkivalot: vilkut,pitkät/ lyhyet,vapaa, öljynpaine
- Vesitiivis
- Voidaan kiinnittää myös ohjaustankoon max. 1 1/4"
- Tarvikkeet tulee mukana
- Ulkomitat 40x120x28.5mm

Tuoteno	Tuote	Hinta
29-8000	Asura digitaalinen monit.mittari Kromi	189,-
29-8001	Asura digitaalinen monit.mittari Musta	161,-

Puig



Laptimer

Erittäin edullinen ja helpokäyttöinen laptimer harastajakäyttöön. Tallentaa nopeimman ja hitaamman kierroksen, keskikierrosaika ja totaali aika. 99 minuutin ja 64 kierroksen muisti. Toleranssi per kierros +/- 0,0035 sekuntia. Kiinnitys tarranauhalla, mitat 60x40x12mm.

Til.no	Hinta
33-5866	72,-



Vanteet ja renkaat



Talvituetteet



Vinsit



Laukut ja tuulisuojat



Sähköosat



Jousitus ja voimansiirto



Pakoputket ja suutinsarjat



Ohjaus



Rungon osat ja peitteet



Jarrupalat ja rattaat



Moottori



Variaattorin osat



Maatalous-tarvikkeet



Kärryt ja reet

ATV





Vanteet ja renkaat



Talvituotteet



Vinssit



Laukut ja tuulisuojat



Sähköosat



Jousitus ja voimansiirto



Pakoputket ja suutinsarjat



Ohjaus



Rungon osat ja peitteet



Jarrupalat ja rattaat



Moottori



Variaattorin osat



Maatalous-tarvikkeet



Kärryt ja reet

ATV

ATV

ATV

ATV

ATV

ATV

uutuus!



Prox tuntimittari

Toimii kaikissa 2/4t moottoreissa myös uudemmissa ruiskumalleissa.

- Helppo asentaa
- Patterin kestoikä 10v
- Vesitiivis ja iskunkestävä rakenne
- Tarkkuus 0.1h

Tuotenumero	Hinta
400-43-HM001	43,50

uutuus!



Prox kierros/tuntimittari

Toimii kaikissa 2/4t moottoreissa myös uudemmissa ruiskumalleissa. Kierros-tunnistimen asetus muunneltavissa eri syytysjärjestelmille.

- 0-20 000 rpm/min
- Huoltovälihälytys
- Kaksi tuntulaskuria: nollattava ja ei-nollattava
- Helppo asentaa
- Patterin kestoikä 10v
- Vesitiivis ja iskunkestävä rakenne
- Tarkkuus 0.1h

Tuotenumero	Hinta
400-43-HM002	43,50

uutuus!



Tuntimittari langaton

- Aktivoituu värinästä automaattisesti (herkkyys muokattavissa)
- Helppolukuinen näyttö
- Pieni koko ja kevyt
- Langaton
- IP68 vesitiivis
- Kaksipuolinen teippi mukana
- Kaksi mittauskokonaisuutta ja "trippi" joka on nollattavissa

Tuotenumero	Hinta
12-420	49,00



Psychic tuntimittari

Tuotenumero	Hinta
12-415	39,00



OXFORD
Essential Rider Equipment

Oxford kello&lämpömittari

Kello, lämpömittari, päivävyri, taustavalo. Vesitiivis -10 - +50

Tuotenumero	Tuote	Hinta
29-219	Oxford Kello&lämpömittari vesitiivis	31,00

VIRRAN ULOSOTTO



9-3-4100



9-3-4101

9-3-4102

Tuotenumero	Tuote	Ovh.
9-3-4100	Virranulosotto DIN	19,50
9-3-4101	Virranulosotto	19,50
9-3-4102	Virranulosotto USB *2 (5 V, 2 Amp)	32,50

PEILIT & ADAPTERIT



Tuotenumero	Tuote	Kiin.	Ovh.
307-3016	PEILI, KROMIVARSI	M8	7,50



Tuotenumero	Tuote	Kiin.	Ovh.
76-12662	PEILIPARI	M8	26,50



Tuotenumero	Tuote	Kiin.	Ovh.
307-3017	PEILI, KOKOMUSTA	M8	8,50



Tuotenumero	Tuote	Ovh.
76-12481	ADAPTERI 8mm VASEN	20,20
76-12481-1	ADAPTERI 8mm OIKEA	20,20
76-12481-2	ADAPTERI 10mm VASEN	20,20
76-12481-3	ADAPTERI 10mm OIKEA	20,20



TUPIT JA OHJAUSTANGON TARVIKKEET

ProTaper SE	Black	Platinum	A (mm) Leveys	B (mm) Korkeus	C (mm) Nousu	D (mm) Kiinnitys- leveys	E (mm) Pullback	F (mm) Suora osa	Osh
ATV Low		63-5277-7	813	140	88	228	84	206	84,-
ATV Mid		63-5278-7	813	150	93	237	76	206	84,-
ATV Hi		63-5279-7	813	160	104	236	100	199	84,-
Raptor	63-5293-0		770	143	115	161	87	206	84,-

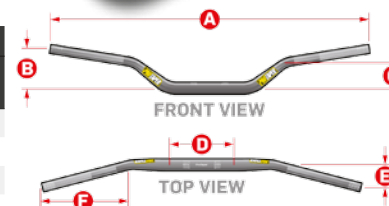

TUPIT

Kaikkia Pro Taper-tupeissa käytetään Kraton-erikoiskumiseosta, joka takaa äärimmäisen hyvän pidon ja tuntuman.



Muut Protaper-tuotteet crossitekniikka-osiossa!



Grip ATV Pillow Lite

Tuoteno	Hinta
63-0015	19,50



Grip ATV 1/2 Waffle Soft

Tuoteno	Hinta
63-0013-1	14,20



Grip ATV Full Waffle Medium

Tuoteno	Hinta
63-0013-2	14,20



Grip ATV Diamond Dual Density

Tuoteno	Hinta
63-0013-3	19,50



ATV Quattro **uutuus!**

Tuoteno	Väri	Hinta
5-2136-0	Musta, Ø22-22	18,50

uutuus!



Radial Full Waffle ATV

Tuoteno	Väri	Hinta
62-355-0	Radial Full Waffle ATV	9,00



Tie-downs

Maailman parhaat remmit!
Jotain ihan muuta kuin halpisketjujen tarjoamat kertakäyttöliinat.

- Patentoitu 360 astetta pyörivä karbiinikoukko toisessa päässä.
- 215cm pitkät ja 38mm leveät nailonremmit
- 550 kilon vetolujuus
- heavy-duty "buckle"
- tarranauhut pitävät remmit järjestyksessä kun et käytä niitä
- Toisessa päässä sekä tukevat koukut että pehmustetut lenkit tankokiinnitystä varten.

Tuoteno.	Väri	Hinta
63-2819	Musta/kelt	54,90 / pari



Kiinnityshihnat + tankokiinnikkeet

Tuoteno	Hinta
9-3-150	45,-



Vanteet ja renkaat



Talvituotteet



Vinsit



Laukut ja tuulisuojat



Sähköosat



Jousitus ja voimansiirto



Pakoputket ja suutinsarjat



Ohjaus



Rungon osat ja peitteet



Jarrupalat ja rattaat



Moottori



Variaattorin osat



Maatalous-tarvikkeet



Kärryt ja reet

ATV





KOROTUSPALASARJA

Moottoripyöriin, mopoihin sekä mönkijöihin

22mm tangoille

Leveys 12cm

Tuotenumero	Tuote	Hinta
862-45430	2" korotuspalat	75,00
862-45432	3" korotuspalat	80,00

Fat bar tangoille

Leveys 12cm

Tuotenumero	Tuote	Hinta
862-45431	2" korotuspalat	75,00
862-45433	3" korotuspalat	80,00



Vanteet ja renkaat



Talvituotteet



Vinsit



Laukut ja tuulisuojat

KOROTUSPALASARJA

Moottorikelkoihin sekä Can am/Polaris -mönkijöihin

22mm tangoille

Leveys 8,5cm

Tuotenumero	Tuote	Hinta
862-45420	Korotuspalat 2"	69,00

Fat bar tangoille

Leveys 8,5cm

Tuotenumero	Tuote	Hinta
862-45421	Korotuspalat 2"	69,00



Sähköosat



Jousitus ja voimansiirto



Pakoputket ja suutinsarjat

OHJAUSTANGON TARVIKKEET



Ohjaus



88-14269



Rungon osat ja peitteet



Jarrupalat ja rattaat

Käsisuoja

Tuotenumero	Väri	Hinta
862-34200	Hopea/Musta	50,00 / Pari
862-34201	Keltainen/Musta Ski-doo	50,00 / Pari
862-34202	Punainen/Musta Polaris	50,00 / Pari
862-34204	Sininen/Musta Yamaha	50,00 / Pari
862-34205	Oranssi/Musta	50,00 / Pari
862-34206	Keltainen/Musta	50,00 / Pari
862-34208	Valkoinen/Musta	50,00 / Pari
862-34210	Musta/Musta	50,00 / Pari
862-34221	Sininen/Valkoinen	50,00 / Pari
862-34230	Musta/Hopea	50,00 / Pari
862-34231	Sininen/Hopea	50,00 / Pari
862-34232	Punainen/Hopea	50,00 / Pari

Käsisuojan lisäsuojat

Väri	Tuotenumero	Hinta
Musta	862-34240	14,20 pari
Oranssi	862-34245	14,20 pari
Valkoinen	862-34248	14,20 pari
Hopea	862-34270	14,20 pari



88-14250

88-14252

Kiinnitysarjat

Tuotenumero	Väri	Hinta
862-34252	Kiinityssarja mönkijä	42,40
862-34250	Kiinityssarja moottorikelkka	42,40
862-34269	Kiinityssarja mönkijä/moottorikelkka/offroad	49,40



Moottori



Variaattorin osat



Maatalous-tarvikkeet



Kärryt ja reet

88-14277



88-14276



Iskunvaimentimen suojaussit

HUOM! Myydään kappaleittain.

Tuotenumero	Väri	Mitat	Hinta
862-64263	Lyhyt	7x28cm	15,00
862-64264	Pitkä	7,6x33cm	15,00



Tarvikkeet

Tuotenumero	Väri	Hinta
862-34255	Peilisarja	33,00

Pehmeä lisäsuojapari

Tuotenumero	Väri	Hinta
862-34277	Lisäsuojapari	49,00
862-34276	Lisäsuojapari	63,00

ATV



OHJAUSTANGON TARVIKKEET

BRONCO
ATV COMPONENTS



Kädensijan lämmitin, yleismalli

Hi-low-off -kytkin.

Tuotenumero	Tuote	Ovh.
71-165137	Yleismalli	64,10

BRONCO
ATV COMPONENTS



Kädensijan lämmitin, peukalon lämmittimellä

Hi-low-off -kytkin.

Tuotenumero	Tuote	Ovh.
71-165138	Peukalon lämmittimellä	85,30

BRONCO
ATV COMPONENTS



Kädensijan lämmitin, yleismalli

Hi-low-off -kytkin.

Tuotenumero	Ovh.
71-51831	46,70

OXFORD
Essential Rider Equipment



Oxford HotHands Carbon tech

- Nopeat asentaa ja poistaa
- Tarvitsee vain alle 3A virtaa
- Asennetaan kahvakum.päälle (22 mm)
- Säännestävä katkaisin 2-tehoaluetta
- Infrapunalla toteutettu FAR INFRARED TECHNOLOGY (FIR)
- Luotettava ja kestävä (takuu 2v)

Tuotenumero	Tuote	Ovh.
5-4182	Oxford HotHands Carbon tech	73,50

OXFORD
Essential Rider Equipment



Oxford HotHands

- Nopeat asentaa ja poistaa
- Asennetaan kahvakum.päälle (22 mm)
- Säännestävä katkaisin 2-tehoaluetta
- Takuu 2v

Tuotenumero	Tuote	Ovh.
5-4184	Oxford HotHands	73,10

OXFORD
Essential Rider Equipment

Uudistunut!

uutuus!

Oxford ATV Hot Grips Premium

Suunniteltu atv ja moottorikelkkoihin. Kahvan sisäpäässä kaulus pienempi kuin moottoripyöriin tarkoitetuissa sekä kahvakumista johdon ulostulo pieni - näin saadaan toimivuus kaasuvivun kanssa helpoksi.

Pidempi johtosarja tarkoittaa käytännössä, että laite on helpompi reitittää aakalle. Kahvakumeja voidaan myös lyhentää koska joissain laitteissa kahvakumien vaativa tila on lyhyempi.

Tuotenumero	Tuote	Ovh.
5-4198	Oxford ATV Hot Grips	86,00



Vanteet ja renkaat



Talvituotteet



Vinsit



Laukut ja tuulisuojat



Sähköosat



Jousitus ja voimansiirto



Pakoputket ja suutinsarjat



Ohjaus



Rungon osat ja peitteet



Jarrupalat ja rattaat



Moottori



Variaattorin osat



Maatalous-tarvikkeet



Kärryt ja reet

Kädensijan lämmitinelementti

BRONCO
ATV COMPONENTS



Tuotenumero	Tuote	Hinta
92-163	KÄDENSIJAN LÄMMITIN 15w	31,00
92-167	KÄDENSIJAN LÄMMITIN 20w	31,00

Peukalon lämmitinsarja

uutuus!

BRONCO
ATV COMPONENTS



Tuotenumero	Tuote	Hinta
71-12750	Peukalonlämmitinsarja	27,90

ATV





ATV

KAASUVAIJERIT



CAN-AM		Tuotenro	
Outlander 330 STD 4X4	2003 - 05	78-1011032	14,80
Outlander 330 STD 2X4	2004-05	78-1011032	14,80
Outlander 400	2003	78-1011032	14,80
Outlander 400 XT 4X4	2004-07	78-1011032	14,80
Outlander 400 MAX	2004-05	78-1011032	14,80
Outlander 400 MAX XT,STD	2006-07	78-1011032	14,80
Outlander 400 STD 2X4,4X4	2004-07	78-1011032	14,80
Outlander 500 XT,MAX,STD	2007	78-1011031	15,80
DS 650	2000-05	78-1011031	15,80
DS 650X	2005-07	78-1011031	15,80
Outlander 650 MAX XT,STD	2007-11	78-1011031	15,80
Outlander 800 XT,MAX,STD	2006-11	78-1011031	15,80

HONDA		Tuotenro	
TRX200	1990-91	78-102254	21,80
TRX200D	1991-95	78-102254	21,80
TRX200D	1996-97	78-102254	21,80
ATC250ES	1985	78-102135	15,80
ATC250SX	1985-87	78-102135	15,80
TRX250	1985	78-102135	15,80
TRX250	1986-87	78-102184	14,80
TRX250	1997-01	78-102202	13,80
TRX250EX	2001-05	78-102202	13,80
TRX250EX	2006-08	78-102546	31,00
TRX250TE/TM	1999-04	78-102202	13,80
TRX250TE/TM	2005-09	78-102561	31,00
TRX250D	1997-02	78-102202	13,80
TRX250X	1987-92	78-102135	15,80
TRX300	1988-92	78-102282	17,30
TRX300	1993-95	78-102282	17,30
TRX300	1996-00	78-102282	17,30
TRX300EX	1993-06	78-102135	15,80
TRX300EX	2007-08	78-102135	15,80
TRX300FW	1988	78-102282	17,30
TRX300FW	1993-95	78-102282	17,30
TRX300FW	1996-00	78-102282	17,30
ATC350X	1985	78-102135	15,80
ATC350X	1986	78-102135	15,80
TRX350	1986-87	78-102184	14,80
TRX350D	1987-89	78-102184	14,80
TRX350FE/TE/FM/TM	2000-03	78-102375	15,30
TRX350FE/TE/FM/TM	2004-06	78-102375	15,30
TRX400EX	1999-04	78-102517	31,00
TRX400EX	2005-07	78-102517	31,00
TRX400EX	2008	78-102517	31,00
TRX400FA/FGA	2004-07	78-102375	15,30
TRX400FW/FM	1995-03	78-102375	15,30
TRX420FE/FM/TE/TM/FA	2007-09	78-102375	15,30
TRX450S/ES	1998-01	78-102375	15,30
TRX450ER	2006-08	78-102408	14,30
TRX450R	2004-08	78-102408	14,30
TRX450FE/FM	2002-04	78-102375	15,30
TRX500FA/FGA	2001-04	78-102375	15,30
TRX500FA/FGA	2005-12	78-101519	31,00
TRX650FA/FGA	2003-05	78-102375	15,30
TRX680FA	2006-	78-102375	15,30
TRX700XX	2008-	78-102568	14,30

KAWASAKI		Tuotenro	
KLF300A	1986	78-103091	14,30
KLF300A	1987	78-103091	14,30
KLF300B Bayou	1988-04	78-103091	14,30
KLF300C 4X4	1988-04	78-103091	14,30
KVF300A 4X4	1999-02	78-103201	19,80
KVF300B	1999-02	78-103201	19,80
KVF360 PRAIRIE A/C	2003-06	78-103349	22,80
KVF360 PRAIRIE A/C	2007-08	78-103349	22,80
KLF400B 4X4	1993-96	78-103201	19,80
KLF400B 4X4	1993-96	78-103201	19,80
KLF400B 4X4	1998-99	78-103201	19,80
KVF400A 4X4/2X4	1997-02	78-103201	19,80
KVF400B	1998-00	78-103201	19,80
KVF650 Brute Force	2005-06	78-103350	18,80
KVF650 A/B	2002-03	78-103350	18,80
KVF650 D/E	2005-13	78-103350	18,80
KVF650 F/G	2006-13	78-103362	23,30
KVF650 H	2007-08	78-103362	23,30
KSV700 V-Force	2004-08	78-103350	18,80
KVF700 A/B/D	2004-05	78-103350	18,80
KVF750 A/B/C	2005-07	78-103362	23,30
KVF750 D/E/F	2008-12	78-103379	31,00

POLARIS		Tuotenro	
BIG BOSS 250 4X6	1989	78-110052	27,50
P250 TRAIL BLAZER	1990-98	78-110052	27,50
P250R/es TRAILBOSS	1989-99	78-110052	27,50
P300 TRAILBOSS 2X4	1989-93	78-110052	27,50
P250 TRAILBOSS 4X4	1989-93	78-110052	27,50
250 BIGBOSS 4X6	1989-92	78-110052	27,50
250 BIGBOSS 6X6	1991-93	78-110052	27,50
P300 TRAIL BLAZER 300 2X4	1994-95	78-110052	27,50
P300 TRAIL BLAZER 300 4X4	1994-95	78-110052	27,50
P300 TRAIL BLAZER 300 6X6	1994-95	78-110052	27,50
300 HAWKEYE 2X4/4X4	2006-07	78-110090	21,30
P325 Magnum 2x4	2002	78-110090	21,30
P325B Magnum HDS 4x4	2001-02	78-110090	21,30
P325B Trail Boss	2002-03	78-110090	21,30
P325L Expedition	2002	78-110090	21,30
P330L Trail Boss	2003-13	78-110090	21,30
P350L TRAILBOSS 2X4	1990-93	78-110051	29,50
P350L TRAILBOSS 4X4	1990-93	78-110051	29,50
P350L TRAILBOSS 6X6	1993	78-110051	29,50
SPORTSMAN 4X4	1993-96	78-110051	29,50
SPORT 400L 6X6	1994-96	78-110051	29,50
P400L SPORTSMAN	1994-97	78-110051	29,50
P400L SPORTSMAN	2001-04	78-110090	21,30
400 SPORTSMAN HO	2008-13	78-110090	21,30
BIGBOSS 6X6	1997	78-110051	29,50
P425L MAGNUM 2X4	1995-97	78-110098	31,00
P425L MAGNUM 4X4	1995-97	78-110098	31,00
P450L Expedition	2000	78-110090	21,30
P450L Expedition	2001-02	78-110090	21,30
P450L Sportsman	2006-07	78-110090	21,30
P500L PREDATOR/LE	2003-07	78-110090	21,30
P500L ATP	2004	78-110090	21,30
P500L Big Boss 6x6	2001-03	78-110090	21,30
P500L Magnum/HDS/RMK	2001-03	78-110090	21,30
P500LScrambler 4x4	1997	78-110098	31,00
P500LScrambler 4x4	1999-12	78-110090	21,30
500 Outlaw	2006-07	78-110090	21,30
P500L Sportsman	1996-98	78-110098	31,00
P500L Sportsman/RSE	1999-00	78-110090	21,30
P500L Sportsman/HO/RSE	2001-13	78-110090	21,30
500 Sportsman EFI	2006-07	78-110051	29,50
P500L Sportman 6x6	2001-02	78-110090	21,30
P500L Worker	2001-02	78-110090	21,30
P600L Sportsman Twin	2003-05	78-110090	21,30
P700L MV7	2005	78-110090	21,30
P700L Sportsman Twin	2002-06	78-110090	21,30
800 Sportsman	2005-12	78-110107	31,00

SUZUKI		Tuotenro	
LT-F 300F	1999-00	78-104119	18,30
LT-F 4WD	1997-98	78-104119	18,30
LT-F 4WDX	1991-98	78-104119	18,30
LTA400	2002-04	78-104249	22,30
LT-A400F	2002-06	78-104249	22,30
LT-F400F	2002-06	78-104249	22,30
LTF400	2002-06	78-104249	22,30
LTZ400	2003-08	78-104228	18,30
LTR450	2006-09	78-104258	19,30
LTA450X	2007-08	78-104248	19,30
LTF,LTA 500F Vinson	2002-03	78-104233	18,30
LTF,LTA 500F Vinson	2004-06	78-104250	18,30
LTA700X	2005-08	78-104248	19,30
LTA750X	2009-	78-104248	19,30

YAMAHA		Tuotenro	
YFM80 Moto 4/Badger	1992-01	78-105191	16,30
YFM80 Grizzly	2005-08	78-105191	16,30
YFM80 Raptor	2002-08	78-105191	16,30
YFM100	1989-91	78-105191	16,30
YFS200 BLASTER	1988-02	78-105118	14,80
YFS200 BLASTER	2003-06	78-105118	14,80
YFM225	1987-88	78-105165	18,30
YFB250FW	1994-00	78-105193	14,30
YFB250U	1996-98	78-105193	14,30
YFM250	1989-91	78-105165	18,30
YFM250 BRUIN	2005-06	78-105349	19,30
YFM250 BIG BEAR	2007-09	78-105349	19,30
YTZ250	1985-86	78-105165	18,30
YFM350FX	1996-05	78-105154	18,30
YFM350U	1996-98	78-105154	18,30



KAASUVAIJERIT JATKUU

YAMAHA	Tuotenro		
YFM350ER	1987	78-105165	18,30
YFM350ER	1994-95	78-105153	12,10
YFM350FW	1993-97	78-105154	18,30
YFM350FA	2004-06	78-105282	17,80
YFM350FG/GW	2007-08	78-105282	17,80
YFM350SE	1997	78-105154	18,30
YFM350X WARRIOR	1993-04	78-105153	12,10
YFM350X WOLVERINE	2007-08	78-105282	17,80
YFM350A	2004	78-105282	17,80
YFM350BA	2005-06	78-105282	17,80
YFZ350 BANSHEE	1987-06	78-105136	25,00
YFM350 RAPTOR	2004-08	78-105327	15,30
YFM400FW	1993-95	78-105154	18,30
YFM400FW	1996-98	78-105154	18,30
YFM400A	2000-04	78-105282	17,80
YFM400F	2000-07	78-105349	19,30
YFM400FA	2000-06	78-105282	17,80
YFM400 KODIAK	2000-08	78-105349	19,30
YFM400N/P/S	2000-04	78-105349	19,30
YFM450 FA/FS/FG/FX	2003-08	78-105282	17,80
YFZ450	2004-07	78-105315	16,30
YFZ450	2008	78-105315	16,30
YFM600	1998-01	78-105165	18,30
YFM660R	2001-05	78-105241	16,30
YFM660F GRIZZLY	2002-08	78-105284	18,30
YFM700F GRIZZLY	2007-	78-105352	24,30
YFM 700R	2006-	78-105337	24,30

KYTKINVAIJERIT

HONDA	KYTKINVAIJERIT		
TRX300EX	1993-06	78-102108	17,80
TRX300EX	2007-08	78-102108	17,80
TRX400EX	1999-04	78-102382	16,30
TRX400EX	2005-07	78-102518	20,30
TRX400EX	2008	78-102548	20,30
TRX450ER	2006-08	78-102405	15,30
TRX450R	2004-08	78-102405	15,30
TRX700XX	2008-09	78-102572	15,30
KAWASAKI	KYTKINVAIJERIT		
KSF400 KFX	2003-06	78-104232	23,30
POLARIS	KYTKINVAIJERIT		
P500L PREDATOR/LE	2003-07	78-05308	33,00
SUZUKI	KYTKINVAIJERIT		
LTX400	2003-08	78-104232	23,30
LTX450	2006-09	78-104262	20,80
YAMAHA	KYTKINVAIJERIT		
YFS200 BLASTER	1988-02	78-105119	16,30
YFS200 BLASTER	2003-06	78-105119	16,30
YFM350X WARRIOR	1993-04	78-105092	17,30
YFZ350 BANSHEE	1987-06	78-105111	16,30
YFM350 RAPTOR	2004-08	78-105328	26,00
YFM660R	2001-05	78-105271	26,50
YFM 700R	2006-08	78-105338	21,80

RIKASTINVAIJERIT

HONDA	VM	RIKASTINVAIJERI	HINTA
TRX300	1988-92	78-102289	13,30
TRX300	1993-95	78-102289	13,30
TRX300	1996-00	78-102359	13,30
TRX300FW	1988	78-102289	13,30
TRX300FW	1993-95	78-102289	13,30
TRX300FW	1996-00	78-102359	13,30
TRX350	1986-87	78-102179	13,30
TRX350D	1987-89	78-102179	13,30
KAWASAKI	RIKASTINVAIJERI		
KLF300A	1987	78-103194	13,30
KLF300B Bayou	1988-04	78-103194	13,30
KLF300C 4X4	1988-04	78-103194	13,30
KVF300A 4X4	1999-02	78-103194	13,30
KVF300B	1999-02	78-103194	13,30
KLF400B 4X4	1993-96	78-103194	13,30
KLF400B 4X4	1993-96	78-103194	13,30
KLF400B 4X4	1998-99	78-103194	13,30
KVF400A 4X4/2X4	1997-02	78-103194	13,30
KVF400B	1998-02	78-103194	13,30
POLARIS	RIKASTINVAIJERI		
Kaikki 250/300/350/400	1988-00	78-110053	13,30
BIG BOSS 250 4X6	1989	78-110053	13,30
P250R/es TRAILBOSS	1989-99	78-110053	13,30
P250 TRAILBOSS 2X4	1989-93	78-110053	13,30
P250 TRAILBOSS 4X4	1989-93	78-110053	13,30
250 BIGBOSS 4X6	1989-92	78-110053	13,30
250 BIGBOSS 6X6	1991-93	78-110053	13,30
P300 TRAIL BLAZER 300 2X4	1994-95	78-110053	13,30
P300 TRAIL BLAZER 300 4X4	1994-95	78-110053	13,30
P300 TRAIL BLAZER 300 6X6	1994-95	78-110053	13,30
300 HAWKEYE 2X4/4X4	2006-07	78-110088	13,30
P325 Magnum 2x4	2002	78-110088	13,30
P325B Magnum HDS 4x4	2001-02	78-110088	13,30
P325L Expedition	2002	78-110088	13,30
P330L ATP	2004-05	78-110088	13,30
P350L TRAILBOSS 2X4	1990-93	78-110053	13,30
P350L TRAILBOSS 4X4	1990-93	78-110053	13,30
P350L TRAILBOSS 6X6	1993	78-110053	13,30
SPORT 400L 6X6	1994-96	78-110053	13,30
P400L SPORTSMAN	1994-97	78-110053	13,30
P400L SPORTSMAN	2001-04	78-110088	13,30
P425L MAGNUM 2X4	1995-97	78-109094	13,30
P425L MAGNUM 4X4	1995-97	78-109094	13,30
P425L MAGNUM 6X6	1996-97	78-109094	13,30
P450L Expedition	2001-02	78-110088	13,30
P500L Big Boss 6x6	2001-03	78-110088	13,30
P500L Magnum/HDS/RMK	2001-03	78-110088	13,30
P500L Scrambler 4x4	1997	78-109094	13,30
P500L Scrambler 4x4	1999-00	78-110088	13,30
P500L Sportsman	1996-98	78-109094	13,30
P500L Sportsman/RSE	1999-00	78-109094	13,30
P500L Sportsman/HO/RSE	2001-06	78-110088	13,30
P500L Sportman 6x6	2001-06	78-110088	13,30
P500L Worker	2001-02	78-110088	13,30
P600L Sportsman Twin	2003-05	78-110088	13,30
P700L MV7	2005	78-110088	13,30
P700L Sportsman Twin	2002-06	78-110088	13,30
SUZUKI	RIKASTINVAIJERI		
LT230E	1987-93	78-104112	13,30
LT-F 250	1988-93	78-104112	13,30
LT-F 250	1990-99	78-104112	13,30
LT-F 250	2000	78-104112	13,30
LT-F 250	2001	78-104112	13,30
LT300E	1987-89	78-104112	13,30
LT-F 300F	1999-00	78-104112	13,30
LT-F 300F	2000-02	78-104112	13,30
LT 4WD	1987-89	78-104112	13,30
LT-F 4WD	1997-98	78-104112	13,30
LT-F 4WDX	1991-98	78-104112	13,30



Vanteet ja renkaat



Talvituotteet



Vinsit



Laukut ja tuulisuojat



Sähköosat



Jousitus ja voimansiirto



Pakoputket ja suutinsarjat



Ohjaus



Rungon osat ja peitteet



Jarrupalat ja rattaat



Moottori



Variaattorin osat



Maatalous-tarvikkeet



Kärryt ja reet



ATV



JALKAJARRUVAIJERIT

HONDA	VM	Jalkajarruvaijeri	HINTA
TRX 300	1993-99	78-102354	12,10
TRX 300 FW	1993-99	78-102354	12,10
TRX 350	1986-87	78-102183	12,10
TRX 350D	1987-89	78-102183	12,10
TRX 350 FE/TE	2000-02	78-102352	12,10
TRX 400 FW/FM	1995-02	78-102352	12,10
TRX 450 S/ES	1998-02	78-102352	12,10

SUZUKI	VM	Jalkajarruvaijeri	HINTA
LT-F 250	2000	78-104159	12,10
LT 4WD	1987-96	78-104159	12,10
LT-F 4WD	1997-98	78-104159	12,10
LT-F 4WDX	1991-98	78-104159	12,10
LT-F 300F	1999-00	78-104159	12,10

KÄSIJARRUVAIJERIT

HONDA	VM	Käsijarruvaijeri taakse	HINTA
TRX 300	1996-99	78-102357	12,10
TRX 350	1986-87	78-102287	12,10
TRX 350D	1987-89	78-102287	12,10
TRX 350 FE/TE	2000-02	78-102355	12,10
TRX 400 FW/FM	1995-02	78-102355	12,10

VAIHEISTOVAIJERIT

HONDA	VM	VAIHEISTOVAIJERI	HINTA
TRX 300	1988-99	78-102361	12,10
TRX 300FW	1988	78-102361	12,10
TRX 300FW	1993-99	78-102361	12,10



Vanteet ja renkaat



Talvituotteet



Vinssit



Laukut ja tuulisuojat



Sähköosat



Jousitus ja voimansiirto



Pakoputket ja suutinsarjat



Ohjaus



Rungon osat ja peitteet



Jarrupalat ja rattaat



Moottori



Variaattorin osat



Maatalous-tarvikkeet



Kärryt ja reet



Kaasun lepuutusvipu

Hyvä kaasuvivun apu. Estää kättä puutumasta pitkällä matkalla

Tuotenro	Hinta
78-12665	13,50



ATV



LOKASUOJASARJAT

Täydellinen sarja eteen ja taakse. Sisältää kiinnitysarjan.
Leveys 60-75mm.



ARCTIC CAT			
1000 THUNDERCAT H2	2009-14	76-175218	231,40
450 H1 EFI	2010-12	76-175227	249,10
500 (M4/LE)	2005-09	76-175218	231,40
550 H1 EFI	2009	76-175218	231,40
550 H1 EFI	2010-14	76-175227	249,10
650 H1	2010-11	76-175227	249,10
650 H1 LE,SE,V2	2005-08	76-175218	231,40
700 EFI,H1 EFI	2006-14	76-175218	231,40
MUD PRO 650	2010-11	76-175218	231,40
MUD PRO 700	2009-14	76-175218	231,40
TRV 1000	2009-14	76-175219	231,40
TRV 400	2006-10	76-175219	231,40
TRV 450	2011-12	76-175219	231,40
TRV 500	2006-08	76-175219	231,40
TRV 500 CORE	2013-14	76-176219	231,40
TRV 550	2009-14	76-175219	231,40
TRV 650	2007-09	76-175219	231,40
TRV 700	2008-14	76-175219	231,40

CAN-AM			
OUTLANDER 400 EFI H.O XT	2006-14	76-175213	231,40
OUTLANDER 500 EFI H.O XT	2007-12	76-175212	231,40
OUTLANDER 500 DPS	2013-14	76-175253	245,00
OUTLANDER 650 EFI H.O XT	2006-12	76-175212	231,40
OUTLANDER 650 DPS	2013-14	76-175253	245,00
OUTLANDER 800 H.O EFI XT	2006-08	76-175212	231,40
OUTLANDER 800R EFI	2009-11	76-175212	231,40
OUTLANDER 800R EFI XMR	2012	76-175212	231,40
OUTLANDER 800R DPS	2012-14	76-175253	245,00
OUTLANDER 1000 EFI DPS	2012-14	76-175253	245,00
OUTLANDER MAX 400 EFI H.O XT	2006-14	76-175213	231,40
OUTLANDER MAX 500 EFI H.O XT	2007-12	76-175212	231,40
OUTLANDER MAX 500 DPS	2013-14	76-175253	245,00
OUTLANDER MAX 650 EFI H.O XT	2006-12	76-175212	231,40
OUTLANDER MAX 800 H.O EFI XT	2006-08	76-175212	231,40
OUTLANDER MAX 800R EFI	2009-12	76-175212	231,40
RENEGADE 500 EFI H.O	2008-11	76-175214	240,00
RENEGADE 500 EFI	2012-14	76-175214	240,00
RENEGADE 800 H.O EFI	2007-08	76-175214	240,00
RENEGADE 800R EFI	2009-14	76-175214	240,00



HONDA			
TRX 420	2007-14	76-175211	231,40
TRX 500 FOREMAN,RUBICON	2005-14	76-175221	251,10
TRX 500 FOREMAN FM/FE/FPM/FPE	2012-13	76-175158	245,00
TRX 650	2003-05	76-175223	249,10
TRX 680	2006-14	76-175223	249,10

KAWASAKI			
BRUTE FORCE 650 4x4i	2006-14	76-175217	180,50
BRUTE FORCE 750 4x4i	2005-11	76-175217	180,50
BRUTE FORCE 750 4x4i	2012-14	76-175249	245,00

POLARIS			
SCRAMBLER 850	2013-14	76-175318	245,00
SPORTSMAN 400	2005	76-175216	231,40
SPORTSMAN 400 HO	2011-14	76-175252	245,00
SPORTSMAN 450	2006-07	76-175216	231,40
SPORTSMAN 500	2005-10	76-175216	231,40
SPORTSMAN 500 HO	2011-13	76-175252	245,00
SPORTSMAN 550	2010-14	76-175224	252,10
SPORTSMAN 600	2005	76-175216	231,40
SPORTSMAN 700	2005-07	76-175216	231,40
SPORTSMAN 800	2005-10	76-175216	231,40
SPORTSMAN 800 EFI	2011-14	76-175252	245,00
TOURING 500	2008-10	76-175220	231,40
TOURING 800	2008-09	76-175220	231,40
XP 550 EFI	2009-14	76-175224	252,10
SPORTSMAN XP 850	2009-14	76-175224	252,10
TOURING 550 EPS	2010-14	76-175226	252,10
TOURING 850 EPS	2010-14	76-175226	252,10

SUZUKI			
KING QUAD 450	2007	76-175215	231,40
KING QUAD 450 Axi	2008-10	76-175215	231,40
KING QUAD 500 Axi	2009-14	76-175215	231,40
KING QUAD 700	2005-07	76-175215	231,40
KING QUAD 750 Axi	2008-14	76-175215	231,40
YAMAHA			
GRIZZLY 550 FI/EPS	2009-14	76-175210	231,40
GRIZZLY 700 FI/SE	2007-14	76-175210	231,40



Vanteet ja renkaat



Talvituotteet



Vinsit



Laukut ja tuulisuojat



Sähköosat



Jousitus ja voimansiirto



Pakoputket ja suutinsarjat



Ohjaus



Rungon osat ja peitteet



Jarrupalat ja rattaat



Moottori



Variaattorin osat



Maatalous-tarvikkeet



Kärryt ja reet

Muoviklipsit BRONCO

ATV COMPONENTS

Muoviosien kiinnittämiseen.

Tuoteno	Tuotteen nimi & kuvaus	Osh.
76-04290	MUOVIKLIPSIT 10 pakk. Ulkohalk. 20mm Pituus 22mm	6,10
76-04291	MUOVIKLIPSIT 10 pakk. Ulkohalk. 20mm Pituus 25mm	6,60



76-04290



76-04291

ATV



SATULANPÄÄLLISET

Valmistettu tarkalleen mönkijäsi alkuperäistuimen mittojen mukaan. UV-suojattu ja vedenkestävä pinta. Parantaa istuimen pitoa kaikissa ajo-olosuhteissa. Edullisempi vaihtoehto koko istuimen vaihtamiselle, jos vain pinta on vaurioitunut. Helppo asennus.



ARCTIC CAT				
Malli	Vuosim.	Oem	Tuotnr	Hinta
250/300/400 2x2/2x4	1999-02	AM121	76-04600	32,50
375 Auto 2x2/2x4	2002	AM121	76-04600	32,50
500 2x2/2x4 ALL	2000-02	AM121	76-04600	32,50
400 AUTO/FIS AUTO/MAN/TBX	2006-08	1506-209	76-04601	39,00
400 TRV	2006-07/11-13	1506-209	76-04601	39,00
450 STD/GT/TRV	2011-13	1506-209	76-04601	39,00
500 AUTO/AUTO FIS	2005-09	1506-209	76-04601	39,00
500 MAN/FIS MAN	2005-09	1506-209	76-04601	39,00
500 TBX AUTO	2005-06	1506-209	76-04601	39,00
500 TRV	2006-08/2013	1506-209	76-04601	39,00
550 CRUISER/GT/LTD/EFI/TRV	2010-13	1506-209	76-04601	39,00
650 V-TWIN FIS AUTO	2005-06	1506-209	76-04601	39,00
650 H1	2005-08	1506-209	76-04601	39,00
650/MUD PRO/H1	2010-11	1506-209	76-04601	39,00
700 EFI	2006-08	1506-209	76-04601	39,00
700 MUD PRO/TRV/GT/CRUISER/TBX/LTD	2009-13	1506-209	76-04601	39,00
700 DIESEL	2007-08/11-13	1506-209	76-04601	39,00
1000 MUDPRO H2	2010	1506-209	76-04601	39,00
1000 CRUISER/GT/LTD/MUD PRO/TRV	2012-13	1506-209	76-04601	39,00

CAN-AM				
Malli	Vuosim.	Oem	Tuotnr	Hinta
OUTLANDER 500 ALL (Ei MAX)	2007-2012	0821-1406	76-04602	39,00
OUTLANDER 500 ALL	2013	0821-1406	76-04602	39,00
OUTLANDER 650 ALL (Ei MAX)	2007-2012	0821-1406	76-04602	39,00
OUTLANDER 650 ALL	2013	0821-1406	76-04602	39,00
OUTLANDER 800 ALL (Ei MAX)	2006-2012	0821-1406	76-04602	39,00
OUTLANDER 800 ALL	2013	0821-1406	76-04602	39,00
OUTLANDER 1000 ALL	2013	0821-1406	76-04602	39,00
RENEGADE 500 ALL	2008-2013	30-78007-01	76-04603	44,00
RENEGADE 800 ALL	2007-2013	30-78007-01	76-04603	44,00
RENEGADE 1000 EFI 4X4	2012-13	30-78007-01	76-04603	44,00

HONDA				
Malli	Vuosim.	Oem	Tuotnr	Hinta
TRX90	1993-06	AM178	76-04604	32,50
TRX200	1990-98	30-12090-01	76-04605	44,00
TRX250 RECON	1997-05	30-12597-01	76-04606	44,00
TRX250TE/TM FOURTRAX RECON	2005-13	30-12505-01	76-04607	44,00
TRX250EX SPORTRAX	2001-05	30-12502-01	76-04608	44,00
TRX250EX SPORTRAX	2006-08	30-12501-01	76-04612	44,00
TRX250X	1987-92	30-13093-01	76-04609	44,00
TRX300/FOURTRAX	1988-04	30-13088-01	76-04610	44,00
TRX300EX	1993-06	30-13093-01	76-04609	44,00
TRX350/400 FOURTRAX RANCHER (ALL)	2000-03	332194	76-04620	44,00
TRX350/400 FOURTRAX RANCHER (ALL)	2004-07	30-13504-01	76-04611	44,00
TRX400 FW FOREMAN	1995-01	30-14095-01	76-04624	44,00
TRX400 FOREMAN/FOURTRAX	1995-03	AM177	76-04613	35,50
TRX400EX SPORTRAX	1999-07	30-14099-01	76-04614	44,00

HONDA				
Malli	Vuosim.	Oem	Tuotnr	Hinta
TRX420 FOURTRAX RANCHER	2007-10	30-14207-01	76-04615	44,00
TRX420 FOURTRAX RANCHER	2011-13	AM9139	76-04616	32,50
TRX450S/ES FOREMAN	1998-05	30-14598-01	76-04617	44,00
TRX450R	2004-09	30-14504-01	76-04625	44,00
TRX500FW RUBICON	2001-04	30-15001-01	76-04618	44,00
TRX500 FOREMAN/RUBICON	2005-11	30-15005-01	76-04619	44,00
TRX500 FOREMAN	2005-11	30-15005-01	76-04619	44,00
TRX650/680 FOURTRAX RINCON	2005-11	30-16503-01	76-04621	44,00

KAWASAKI				
Malli	Vuosim.	Oem	Tuotnr	Hinta
KFX80	2003-06	332196	76-04622	44,00
KLF220A BAYOU	1988-02	30-22288-01	76-04623	44,00
KLF250 BAYOU	2002-10	30-22288-01	76-04623	44,00
KLF300B BAYOU	1989-04	30-23089-01	76-04629	44,00
KLF300C 4x4 BAYOU	1989-05	AM171	76-04626	32,50
KVF300/400 PRAIRIE	1997-02	30-23097-01	76-04627	44,00
KVF360 PRAIRIE	2002-12	30-23603-01	76-04628	44,00
KLF400 4x4 BAYOU	1993-99	30-23089-01	76-04629	44,00
KXF400	2003-06	30-34003-01	76-04630	44,00
KFX450R	2008-13	30-24508-01	76-04631	44,00
KVF650 BRUTE FORCE	2005-12	30-26502-01	76-04632	44,00
KVF650i/750i BRUTE FORCE	2005-13	30-27505-01	76-04633	44,00
KVF650/700 PRAIRIE	2003-07	30-26502-01	76-04632	44,00
KFX700	2003-09	AM9113	76-04634	36,50

POLARIS				
Malli	Vuosim.	Oem	Tuotnr	Hinta
Kaikki 250-400 2X4/4X4/6X6	1990-95	AM376	76-04635	32,50
300 XPRESS/XPLORAR	1996-99	AM122	76-04636	32,50
325 XPEDITION/MAGNUM	2000-02	AM122	76-04636	32,50
330 TRAILBOSS	2002-09	30-53396-01	76-04637	44,00
335 SPORTSMAN	1999-00	AM122	76-04636	32,50
400 SPORTSMAN	2001-04	30-53396-01	76-04637	44,00
400 SPORTSMAN	2005	30-55005-01	76-04638	36,50
400 XPRESS/XPLRAR/SPORTSMAN	1996-02	AM122	76-04636	32,50
400 HAWKEYE HO	2011-13	30-55005-01	76-04638	36,50
400 SPORTSMAN HO	2013	30-55005-01	76-04638	36,50
425 XPEDITION	2000-02	AM122	76-04636	32,50
450 SPORTSMAN	2006-07	30-55005-01	76-04638	36,50
500 DIESEL	1999-00	AM122	76-04636	32,50
500 SPORTSMAN	2003-04	30-53396-01	76-04637	44,00
500 SPORTSMAN	2005-13	30-55005-01	76-04638	36,50
550 SPORTSMAN	2011-13	2684702/2684701	76-04639	44,00
600 SPORTSMAN	2003-04	30-53396-01	76-04637	44,00
700 SPORTSMAN	2003-04	30-53396-01	76-04637	44,00
700 SPORTSMAN	2005-07	30-55005-01	76-04638	36,50
700 TWIN	2002-03	AM122	76-04636	32,50
800 SPORTSMAN	2005-13	30-55005-01	76-04638	36,50
850 SPORTSMAN XP	2009-10	30-55005-01	76-04638	36,50
850 SPORTSMAN XP	2011-13	2684702/2684701	76-04639	44,00



SATULANPÄÄLLISET JATKUU

SUZUKI				
Malli	Vuosim.	Oem	Tuotenr	Hinta
LT160 QUAD RUNNER	2003-04	30-31689-01	76-04640	44,00
LT-F160 QUAD RUNNER	1989-01	30-31689-01	76-04640	44,00
LT250 4x4	1991-95	AM189	76-04641	32,50
LT250R	1987-93	AM346	76-04642	35,50
LTF250F/300F	1999-02	30-32599-01	76-04643	44,00
LTF250K Ozark	2002-09	AM9135	76-04644	35,50
LTF 4WDX KING QUAD 280	1991-96	AM189	76-04641	32,50
LTF250 QUAD RUNNER	1987-98	30-32588-01	76-04645	44,00
LTZ250 QUADSPORT	2003-09	30-32503-01	76-04646	44,00
LT-4WDX	1991-95	AM189	76-04641	32,50
LT-A/F400 EIGER	2002-07	30-34002-01	76-04647	44,00
LTA/F400 KING QUAD	2008-11	AM9134	76-04648	35,50
LTZ400 QUADSPORT	2003-12	30-34003-01	76-04630	44,00
LTA450 KING QUAD	2006-09	30-33005-01	76-04649	44,00
LTR450 QUADRACER	2006-09	30-34506-01	76-04650	44,00
LTA500 KING QUAD	2009-13	30-33005-01	76-04649	44,00
LT-A500F/S VINSON	2002-07	30-35002-01	76-04651	44,00
LTF500F	1998-02	30-35098-01	76-04652	44,00
LT500R	1987-90	AM347	76-04653	37,50
LTA550 KING QUAD	2012	30-33005-01	76-04649	44,00
LTA700 KING QUAD	2005-11	30-33005-01	76-04649	44,00
LTA750 KING QUAD	2008-13	30-33005-01	76-04649	44,00

YAMAHA				
Malli	Vuosim.	Oem	Tuotenr	Hinta
YFM125 GRIZZLY/HUNTER	2004-12	30-41204-01	76-04654	44,00
YFS200 BLASTER	1988-06	30-42088-01	76-04655	44,00

YAMAHA				
Malli	Vuosim.	Oem	Tuotenr	Hinta
YFB250 TIMBERWOLF/4WD	1992-01	30-42592-01	76-04656	44,00
YFM250 BEARTRACKER	1999-04	AM100	76-04657	32,50
YFM250 BRUIN/BIG BEAR	2005-09	30-44000-01	76-04658	44,00
YFM250 RAPTOR	2008-13	4D3-2470F-00-00	76-04659	44,00
YFM350ER	1987-95	AM362	76-04660	32,50
YFM350FX WOLVERINE	1995-05	332207	76-04661	44,00
YFM350 BIG BEAR	1987-01	30-44093-01	76-04662	35,50
YZF350 BANSHEE	1987-06	30-43587-01	76-04663	44,00
YFM350 BRUIN	2004-06	30-44000-01	76-04658	44,00
YFM350/450 GRIZZLY/HUNTER	2005-13	30-44000-01	76-04658	44,00
YFM350X WARRIOR	1987-05	30-43593-01	76-04664	44,00
YFM350 RAPTOR	2004-13	30-43505-01	76-04665	44,00
YFM400 BIG BEAR	2000-06	30-43500-01	76-04666	44,00
YFM400 BIG BEAR/HUNTER	2007-12	30-44007-01	76-04667	44,00
YFM400 KODIAK	1993-95	332212	76-04676	44,00
YFM450 KODIAK	2000-06	30-44000-01	76-04658	44,00
YFM550 GRIZZLY	2009-11	30-47007-01	76-04668	44,00
YFM550 GRIZZLY	2012-13	AM9131	76-04669	41,00
YFM600	1997-01	30-46098-01	76-04670	44,00
YFM660F GRIZZLY	2002-08	30-46002-01	76-04671	44,00
YFM660R RAPTOR	2001-05	30-46601-01	76-04672	44,00
YFM700 GRIZZLY	2007-12	30-47007-01	76-04668	44,00
YFM700 GRIZZLY	2012-13	AM9131	76-04669	41,00
YFM700R RAPTOR	2006-12	30-47006-01	76-04673	44,00

PEITTEET

BRONCO
ATV COMPONENTS



Peite, tuulenkestävä

Vahvistettu, 600D Polyester

Tuotenro	Väri	Ovh.
76-131-1	camo	73,50

ATV LOGIC



Peite, musta XXL

PU-vahvistettu 210D Nylon

Tuotenro	Ovh.
76-132	103,00

BRONCO
ATV COMPONENTS



Peite, musta

150D Polyester

Tuotenro	Ovh.
76-131	72,00

uutuus!

BRONCO
ATV COMPONENTS



Peite, musta XXL

150D Polyester.
244 x 132 x 127 cm.

Tuotenro	Ovh.
76-134	49,50



Kuljetuspeite, musta

Vahvistettu, 600D Polyester, tuulenkestävä. Kuljetuspeite.

Tuotenro	Ovh.
76-131-2	99,90



Oxford Aquatex peite

OXFORD
Essential Rider Equipment

150D Polyester

Tuotenro	Koko	Ovh.
76-133-1	S - 195X122X80	43,50
76-133-2	M - 208X122X80	45,50
76-133-3	L - 220X125X85	48,50



Vantee ja renkaat



Talvituotteet



Vinsit



Laukut ja tuulisuojat



Sähköosot



Jousitus ja voimansiirto



Pakoputket ja suutinsarjat



Ohjauksen osat



Runگون osat ja peitteet



Jarrupalat ja rattaat



Moottori



Variaattorin osat



Maatalous-tarvikkeet



Kärryt ja reet

ATV





Vanteet ja renkaat



Talvituotteet



Vinssit



Laukut ja tuulisuojat



Sähköosat



Jousitus ja voimansiirto



Pakoputket ja suutinsarjat



Ohjaus



Rungon osat ja peitteet



Jarrupalat ja rattaat



Moottori



Variaattorin osat



Maatalous-tarvikkeet



Kärryt ja reet

ATV

sbs

JARRUPALAT

Käyttövaatimukset ja ajotyylit määrittävät sen, minkälainen jarrupalatarjoaja tarjoaa eri olosuhteissa parhaan ajotuntuman. SBS tarjoaa markkinoiden laajimman jarrupalavalikoiman moottoripyöriin, mönkijöihin, mopoihin yms. Lisäksi saatavilla useita materiaali- ja seosvaihtoehtoja cruisailusta kilpakäyttöön.

Alla olevasta jarrupalavertailusta näet SI- ja RSI-palojen erot eri käyttöolosuhteissa. ATV-käyttöön on tarjolla alla olevien vaihtoehtojen lisäksi mm. ATS-palat, jotka on kehitetty tiettyjen valmistajien (mm. Arctic Cat, Polaris) erikoisvaatimusten mukaisiksi.



sbs

A nice place to stop



Tanskalainen SBS on tunnettu korkeasta laadustaan. SBS tekee jatkuvaa kehitystyötä käyttäen tiedonkeruujärjestelmällä varustettuja moottoripyöriä ja jarrudynoa. Tämän vuoksi saavutetaan maksimaalinen jarruteho ja palojen kestävyys. SBS esitteli ensimmäisenä täysin asbestivapaan jarrupalan moottoripyöriin. Lisäksi SBS on yhteistyössä johtavien kilpatietien kanssa (esim. Ten Kate Honda) varmistamaan parhaan mahdollisen jarrujen suorituskyvyn vaativimmissa mahdollisissa olosuhteissa.



OFF-ROAD SINTER - SI

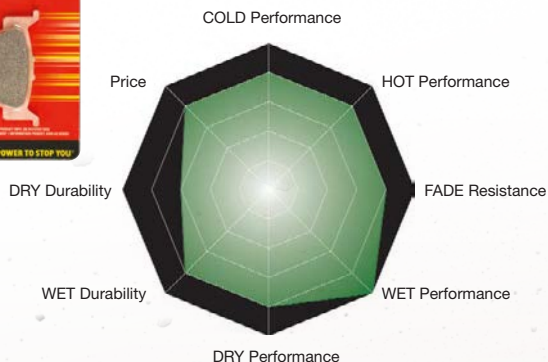

OFF-ROAD RACING SINTER - RSI

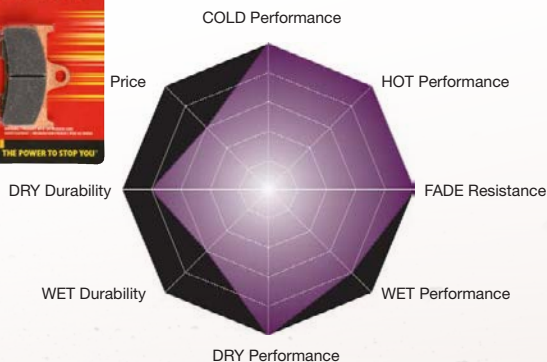

JARRUPALAT SOPIVUUDET

ARCTIC CAT	Vuosi-malli:	Eteen	Ovh	Taakse	Ovh
50 2WD	04-	23-2048*	21,00		
90 2WD	02-	23-2048*	21,00		
250 DVX	06-09	23-810SI*	31,50	23-775SI	31,50
300 2x4	10-	23-822ATS*	31,50	23-822ATS	31,50
300 DVX	09-	23-810SI*	31,50	23-775SI	31,50
400 2x4/4x4 (FIS)(Man. käsijarru)	05-			23-758ATS	31,50
400 TBX 4x4	04-04	23-758ATS*	31,50	23-758ATS	31,50
400 TRV	09-	23-822ATS*	31,50	23-822ATS	31,50
450 H1	10-	23-822ATS*	31,50	23-822ATS	31,50
450 XC	11-	23-822ATS*	31,50	23-822ATS	31,50
454 Bear Cat	96-98	23-758ATS*	31,50	23-758ATS	31,50
500 2x4/4x4 (FIS)	02-04	23-758ATS*	31,50	23-758ATS	31,50
550 H1	09-	23-822ATS*	31,50	23-822ATS	31,50
550 LTD	09-	23-822ATS*	31,50	23-822ATS	31,50
550 Prowler	09-	23-822ATS*	31,50	23-822ATS	31,50
550 TRV	09-	23-822ATS*	31,50	23-822ATS	31,50
650 Prowler	06-	23-822ATS*	31,50	23-822ATS	31,50
700 Diesel	06-	23-822ATS*	31,50	23-822ATS	31,50
700 H1	09-	23-822ATS*	31,50	23-822ATS	31,50
700 Prowler	08-	23-822ATS*	31,50	23-822ATS	31,50
700 TBX	12-	23-822ATS*	31,50	23-822ATS	31,50
700 TRV	09-	23-822ATS*	31,50	23-822ATS	31,50
1000 Prowler	09-	23-822ATS*	31,50	23-822ATS	31,50
1000 Thundercat	09-	23-822ATS*	31,50	23-822ATS	31,50
1000 TRV	09-	23-822ATS*	31,50	23-822ATS	31,50

*jarrut 2:lla levyllä/rummulla

CAN-AM	Vuosi-malli:	Eteen	Ovh	Taakse	Ovh
50 Quest	03-04	23-2048*	21,00	23-2041	30,50
DS 50	02-06	23-2048*	21,00	23-2041	30,50
DS 50	07-	23-2048*	21,00		
DS 70	08-	23-2048*	21,00		
90 Quest	03-04	23-2048*	21,00	23-2041	30,50
DS 90	02-06	23-2048*	21,00	23-2041	30,50
DS 90	07-	23-2048*	21,00		
DS 90 X	08-	23-544SI*	31,50	23-544SI	31,50
DS 250	08-	23-810SI*	31,50	23-810SI	31,50
400 Outlander vasen/ taka	03-	23-754SI	31,50	23-754SI	31,50
400 Outlander oikea	03-	23-767SI	31,50		
DS 450	08-12	23-907SI	32,00	23-642SI	31,50
500 Traxter vasen/taka	03-05	23-754SI	31,50	23-767SI	31,50
500 Traxter oikea	03-05	23-767SI	31,50		
500 Outlander vasen/ taka	07-12	23-754SI	31,50	23-767SI	31,50
500 Outlander oikea	07-12	23-767SI	31,50		
500 Outlander vasen/ taka	13-	23-910SI	32,00	23-910SI	32,00
500 Outlander oikea	13-	23-911SI	32,00		
500 Renegade vasen/ taka	08-11	23-754SI	31,50	23-767SI	31,50
500 Renegade oikea	08-11	23-767SI	31,50		
500 Renegade vasen	12-	23-910SI	32,00	23-910SI	32,00
500 Renegade oikea	12-	23-911SI	32,00	23-911SI	32,00
650 Outlander vasen/ taka	07-12	23-754SI	31,50	23-767SI	31,50
650 Outlander oikea	07-12	23-767SI	31,50		
650 Outlander vasen/ taka	13-	23-910SI	32,00	23-910SI	32,00
650 Outlander oikea	13-	23-911SI	32,00		
650 Quest vasen/taka	03-06	23-754SI	31,50	23-767SI	31,50
650 Quest oikea	03-06	23-767SI	31,50		
650 Traxter vasen/taka	03-05	23-754SI	31,50	23-767SI	31,50
650 Traxter oikea	03-05	23-767SI	31,50		
800 Outlander vasen/ taka	07-11	23-754SI	31,50	23-767SI	31,50

Malli	VM	Eteen	Ovh	Taakse	Ovh
CAN-AM (Bombardier)					
*jarrut 2:lla levyllä/rummulla					
800 Outlander oikea	07-11	23-767SI	31,50		
800 Outlander vasen/ taka	12-	23-910SI	32,00	23-910SI	32,00
800 Outlander oikea	12-	23-911SI	32,00		
800 Renegade vasen/ taka	07-11	23-754SI	31,50	23-767SI	31,50
800 Renegade oikea	07-11	23-767SI	31,50		
800 Renegade vasen	12-	23-910SI	32,00	23-910SI	32,00
800 Renegade oikea	12-	23-911SI	32,00	23-911SI	32,00
1000 Outlander vasen/ taka	12-	23-910SI	32,00	23-910SI	32,00
1000 Outlander oikea	12-	23-911SI	32,00		
1000 Renegade vasen	12-	23-910SI	32,00	23-910SI	32,00
1000 Renegade oikea	12-	23-911SI	32,00	23-911SI	32,00

*jarrut 2:lla levyllä/rummulla

CF MOTO	Vuosi-malli:	Eteen	Ovh	Taakse	Ovh
500 Terralander	13-	23-914SI	32,00	23-799SI	31,50
625 Terralander	11-	23-914SI	32,00	23-799SI	31,50
800 Terralander	12-	23-914SI	32,00	23-799SI	31,50

CPI	Vuosi-malli:	Eteen	Ovh	Taakse	Ovh
250 XS ATV	07-	23-810SI*	31,50		
XS 250 Quad	06-	23-544SI*	31,50	23-848SI	31,50

*jarrut 2:lla levyllä/rummulla

DERBI	Vuosi-malli:	Eteen	Ovh	Taakse	Ovh
DXR 200 Quad (etu levy)	04-	23-544SI*	31,50	23-586SI	31,50
DXR 200 Quad (etu rumpu)	04-	23-2028*	20,00	23-586SI	31,50
DXR 200 Quad (etu rumpu)	04-	23-2028*	20,00	23-611SI	31,50
DXR 250 Quad (etu levy)	04-	23-544SI*	31,50	23-586SI	31,50
DXR 250 Quad (etu rumpu)	04-	23-2028*	20,00	23-586SI	31,50
DXR 250 Quad (etu rumpu)	04-	23-2028*	20,00	23-611SI	31,50

*jarrut 2:lla levyllä/rummulla

E-TON	Vuosi-malli:	Eteen	Ovh	Taakse	Ovh
RXL 150 Viper	07-	23-2012*	15,00		
VXL 250 Vector, ST Vector	06-	23-544SI*	31,50		
VTX 300 Vortex, ST Vortex	07-	23-544SI*	31,50		
VXL 300 Vector, ST Vector	07-	23-544SI*	31,50		

*jarrut 2:lla levyllä/rummulla

HONDA	Vuosi-malli:	Eteen	Ovh	Taakse	Ovh
ATC 70 kaikki mallit	78-85			23-2069	29,50
TRX 70	86-87	23-2048*	21,00	23-2041	30,50
ATC 110 kaikki mallit	79-85			23-2019	26,50
ATC 125 ME, MF, MG, MH	84-87	23-2012	15,00	23-2019	26,50
TRX 125	85-88	23-2012*	15,00	23-2019	26,50
ATC 185 A, S, SB	80-83	23-2012	15,00	23-2019	26,50
ATC 200	81-83	23-2012	15,00	23-2019	26,50
ATC 200 X	83-85	23-592SI	31,50	23-562SI	31,50
TRX 200	84	23-2044*	42,00	23-2019	26,50
TRX 200 / D	90-97			23-2019	26,50
TRX 200 SX	86-88			23-2019	26,50
ATC 250 ES, SX	85-87	23-2019	26,50	23-2024	36,50
ATC 250 R	81	23-536SI	31,50	23-2014	21,00
ATC 250 R	82-86	23-584SI	31,50	23-562SI	31,50
ATC 250 X	85-85	23-558SI	31,50	23-562SI	31,50
FL 250 Odyssey	77-84	23-525HF	33,00	23-2019	26,50
TRX 250	85-87	23-2044*	42,00	23-2024	36,50



Vanteet ja renkaat



Talvituetteet



Vinsit



Laukut ja tuulisuojat



Sähköosat



Jousitus ja voimansiirto



Pakoputket ja suutinsarjat



Ohjaus



Rungon osat ja peitteet



Jarrupalat ja rattaat



Moottori



Variaattorin osat



Maatalous-tarvikkeet



Kärryt ja reet

ATV





JARRUPALAT JATKUU

HONDA	Vuosi-malli:	Eteen	Ovh	Taakse	Ovh
TRX 250 EX Sportrax	01-08	23-592SI*	31,50		
TRX 250 R	86-89	23-603SI*	31,50	23-558SI	31,50
TRX 250 X	08-	23-592SI*	31,50		
TRX 250 X Fourtrax	87	23-603SI*	31,50	23-558SI	31,50
TRX 300	88-00			23-2024	36,50
TRX 300 X	09-	23-592SI*	31,50	23-592SI	31,50
ATC 350 X	85	23-558SI	31,50	23-562SI	31,50
ATC 350 X	86-	23-603SI	31,50	23-562SI	31,50
FL 350 R Odyssey	85-87	23-2044*	42,00	23-610LF	32,00
TRX 350 kaikki mallit	86-89	23-2045	40,00	23-2046	51,50
TRX 350 Rancher /ES 2x4, 4x4	00-	23-2085*	40,00	23-2207	36,50
FL 400 R Pilot	89-90	23-2044*	42,00	23-610LF	32,00
TRX 400 AT	04-	23-2085*	40,00	23-2207	36,50
TRX 400 EX Sportrax	01-08	23-592SI*	31,50	23-592SI	31,50
TRX 400 FW Fourtrax Foreman	95-02	23-2085*	40,00	23-2207	36,50
TRX 400 X	09-	23-592SI*	31,50	23-592SI	31,50
TRX 420 FA / FPA	09-	23-592SI*	31,50	23-813SI	31,50
TRX 420 FPE / FPM	09-	23-592SI*	31,50		
TRX 450 Foreman ES / S	98-	23-2085*	40,00	23-2207	36,50
TRX 450 R	04-	23-694SI*	31,50	23-813SI	31,50
TRX 500 kaikki mallit	05-	23-829SI*	31,50	23-2046	51,50
TRX 500 Foreman, Rubicon	00-04	23-2085*	40,00	23-2072	48,50
TRX 680 FA6 Rincon	06-	23-829SI*	31,50	23-813SI	31,50
TRX 680 FGA6 Rincon	06-	23-829SI*	31,50	23-813SI	31,50
TRX 700 XX	08-	23-694SI*	31,50	23-829SI	31,50

*jarrut 2:lla levyllä/rummulla

HYOSUNG	Vuosi-malli:	Eteen	Ovh	Taakse	Ovh
TE 400	05-06	23-536SI*	31,50	23-649SI	31,50
TE 450	07-	23-536SI*	31,50	23-649SI	31,50

*jarrut 2:lla levyllä/rummulla

KAWASAKI	Vuosi-malli:	Eteen	Ovh	Taakse	Ovh
KLF 110 Mojave	87-88	23-2015*	15,00	23-2183	22,00
KLF 185 Bayou	85-85			23-2038	38,00
KLF 185 Bayou	86-88	23-2040*	32,50	23-2038	38,00
KLT 200	83-84	23-2015	15,00	23-2040	32,50
KLF 220 Bayou	88-02	23-2040*	32,50	23-2038	38,00
KLT 250 Prairie	83-85	23-2015	15,00	23-2040	32,50
KSF 250 Mojave	87-	23-591SI*	31,50	23-592SI	31,50
KXF 250 Tecate	87-88	23-591SI*	31,50	23-592SI	31,50
KXT 250 Tecate	84-84	23-2040	32,50	23-544HF	35,50
KXT 250 Tecate	85-86	23-546SI	31,50	23-586SI	31,50
KXT 250 Tecate	87-	23-591SI	31,50	23-592SI	31,50
KAF 300 Mule 500	92-95	23-2053*	48,00		
KAF 300 Mule 550		23-2053*	48,00		
KEF 300 Lakota	95-	23-591SI*	31,50	23-592SI	31,50
KLF 300 Bayou	86-87	23-2054*	37,00	23-2038*	38,00
KLF 300 Bayou	88-	23-546SI*	31,50	23-2038*	38,00
KLF 300 Bayou vasen/ taka	89-05	23-611SI	31,50	23-2197	48,50
KLF 300 Bayou oikea	89-05	23-638SI	31,50		
KVF 300 Brute Force	13-	23-536SI*	31,50	23-810SI	31,50
KVF 360 Prairie	03-	23-536SI*	31,50		
KFX 400	02-	23-592SI*	31,50	23-649SI	31,50
KLF 400 Bayou vasen/ taka	93-99	23-611SI	31,50	23-2197	48,50
KLF 400 Bayou oikea	93-99	23-638SI	31,50		
KVF 400 Prairie	97-98	23-536SI*	31,50	23-2197	48,50
KVF 400 Prairie	99-	23-536SI*	31,50		
KFX 450 vasen/taka	07-	23-801SI	31,50	23-592SI	31,50
KFX 450 oikea	07-	23-798SI	31,50		
KVF 650 Brute Force vasen	05-	23-801SI	31,50		
KVF 650 Brute Force oikea	05-	23-798SI	31,50		
KVF 650 Prairie vasen	01-03	23-801SI	31,50		

KAWASAKI	Vuosi-malli:	Eteen	Ovh	Taakse	Ovh
KVF 650 Prairie oikea	01-03	23-798SI	31,50		
KFX 700 V-Force vasen	04-	23-801SI	31,50		
KFX 700 V-Force oikea	04-	23-798SI	31,50		
KVF 700 Prairie vasen	04-	23-801SI	31,50		
KVF 700 Prairie oikea	04-	23-798SI	31,50		
KRF 750 Teryx vasen	08-	23-611SI	31,50		
KRF 750 Teryx oikea	08-	23-638SI	31,50		
KVF 750 Brute Force vasen	05-	23-611SI	31,50		
KVF 750 Brute Force oikea	05-	23-638SI	31,50		
KRF/KRT 800 Teryx vasen	14-	23-611SI	31,50		
KRF/KRT 800 Teryx oikea	14-	23-638SI	31,50		

*jarrut 2:lla levyllä/rummulla

KTM	Vuosi-malli:	Eteen	Ovh	Taakse	Ovh
SX 450	08-	23-866RSI*	35,00	23-867RSI	35,00
XC 450	08-	23-866SI*	31,50	23-867SI	31,50
SX 505	08-	23-866RSI*	35,00	23-867RSI	35,00
XC 505	08-	23-866SI*	31,50	23-867SI	31,50

*jarrut 2:lla levyllä/rummulla

KYMCO	Vuosi-malli:	Eteen	Ovh	Taakse	Ovh
50 Mxer	03-	23-2012*	15,00	23-749HF	35,50
50 MXU	05-	23-2012*	15,00	23-749HF	35,50
125 MXer	03-	23-2012*	15,00	23-749HF	35,50
150 MXer	03-	23-2012*	15,00	23-749HF	35,50
150 MXU	05-	23-2012*	15,00	23-749HF	35,50
250 MXU	06-	23-810SI*	31,50	23-775SI	31,50
250 Urban Quad	06-	23-810SI*	31,50	23-775SI	31,50
KXR 250	04-	23-810SI*	31,50	23-775SI	31,50
300 Maxxer	06-	23-810SI*	31,50	23-775SI	31,50
300 MXU	06-	23-810SI*	31,50	23-810SI*	31,50
400 Maxxer	08-	23-822ATS*	31,50	23-822ATS	31,50
400 MXU	08-	23-822ATS*	31,50	23-822ATS	31,50
450 i MXU	13-	23-810SI*	31,50	23-810SI	31,50
450 Maxxer	09-	23-822ATS*	31,50	23-822ATS	31,50
500 MXU	06-	23-810SI*	31,50	23-810SI*	31,50
500 UXV	08-	23-810SI*	31,50	23-810SI	31,50

*jarrut 2:lla levyllä/rummulla

POLARIS	Vuosi-malli:	Eteen	Ovh	Taakse	Ovh
EV-LSV	10-	23-897SI*	31,50	23-800ATS	31,50
LSV 4x4	11-	23-897SI*	31,50	23-800ATS	31,50
MV Diesel Crew	13-	23-897SI*	31,50	23-897SI	31,50
Ranger 2x4, 4x4, 6x6	02-	23-800ATS*	31,50	23-800ATS*	31,50
Ranger 48v EV	13-	23-897SI*	31,50	23-800ATS	31,50
Ranger XP	06-	23-800ATS*	31,50	23-800ATS	31,50
Trail Blazer	90-93	23-716ATS*	31,50	23-717ATS	31,50
Trail Boss 2x4	85-87	23-2028*	20,00		
Trail Boss 2x4, 4x4	88-89	23-716ATS*	31,50	23-717ATS	31,50
50 Predator	04-	23-2048*	21,00		
50 Scrambler	01-03	23-2048*	21,00		
90 Predator	03-	23-2043*	22,00		
90 Scrambler	01-03	23-2048*	21,00		
90 Sportsman	01-	23-2048*	21,00		
200 Phoenix	05-	23-544SI*	31,50	23-546SI	31,50
200 Sawtooth	06-	23-544SI*	31,50	23-544SI	31,50
250 2x4, 4x4	90	23-716ATS*	31,50	23-717ATS	31,50
250 2x4, 4x4	93	23-716ATS*	31,50	23-717ATS	31,50
250 Big Boss 4x6, 6x6	89-93	23-716ATS*	31,50	23-717ATS	31,50
250 Cyclone	87-87	23-2028	20,00	23-643LF	25,50
250 Trail Blazer	94-98	23-716ATS*	31,50	23-717ATS	31,50
250 Trail Blazer	99-	23-716ATS*	31,50	23-755ATS	31,50
250 Trail Boss	88-90	23-642ATS*	31,50	23-643LF	25,50

JARRUPALAT JATKUU



POLARIS	Vuosi-malli:	Eteen	Ovh	Taakse	Ovh
250 Trail Boss	91-99	23-716ATS*	31,50	23-717ATS	31,50
250 Xplorer 4x4	00-	23-716ATS*	31,50	23-755ATS	31,50
300 2x4, 4x4	94-95	23-716ATS*	31,50	23-717ATS	31,50
300 Big Boss 6x6	94	23-716ATS*	31,50	23-717ATS	31,50
300 Hawkeye 2x4, 4x4	06-06	23-822ATS*	31,50	23-822ATS	31,50
300 Hawkeye 2x4, 4x4	07-	23-716ATS*	31,50	23-716ATS	31,50
300 Sportsman 4x4	08-	23-642ATS*	31,50	23-642ATS	31,50
300 Xplorer 4x4	96-	23-716ATS*	31,50	23-717ATS	31,50
300 Xpress 2x4	98-	23-716ATS*	31,50	23-717ATS	31,50
300 Xpress L	96-97	23-716ATS*	31,50	23-717ATS	31,50
325 Magnum 2x4, 4x4	00-02	23-716ATS*	31,50	23-755ATS	31,50
325 Trail Boss	00-02	23-716ATS*	31,50	23-755ATS	31,50
330 ATP	04-05	23-716ATS*	31,50	23-716ATS*	31,50
330 ATP	06-	23-716ATS*	31,50	23-787ATS	31,50
330 E Trail Blazer	08-	23-642ATS*	31,50	23-787ATS	31,50
330 Magnum 2x4, 4x4	03-	23-716ATS*	31,50	23-787ATS	31,50
330 Trail Boss	03-	23-716ATS*	31,50	23-755ATS	31,50
335 Sportsman 4x4	99-	23-716ATS*	31,50	23-755ATS	31,50
350 Big Boss	93	23-716ATS*	31,50	23-717ATS	31,50
350 L 2x4, 4x4	90	23-716ATS*	31,50	23-717ATS	31,50
350 L 4x4	93	23-716ATS*	31,50	23-717ATS	31,50
350 Sportsman 4x4	93	23-716ATS*	31,50	23-717ATS	31,50
350 Trail Boss L 2x4	91-93	23-716ATS*	31,50	23-717ATS	31,50
350 Trail Boss L 4x4	91	23-716ATS*	31,50	23-717ATS	31,50
400 Big Boss L 6x6	96	23-716ATS*	31,50	23-717ATS	31,50
400 Big Boss L 6x6 Middle Axle Brake	96	23-756ATS	31,50		
400 L 2x4	94-95	23-716ATS*	31,50	23-717ATS	31,50
400 L 4x4	94	23-716ATS*	31,50	23-717ATS	31,50
400 Scrambler 2x4	00-	23-716ATS*	31,50	23-755ATS	31,50
400 Scrambler 4x4	98	23-716ATS*	31,50	23-717ATS	31,50
400 Scrambler 4x4	99-	23-716ATS*	31,50	23-755ATS	31,50
400 Scrambler L 4x4	95-97	23-716ATS*	31,50	23-717ATS	31,50
400 Sport L	94-98	23-716ATS*	31,50	23-717ATS	31,50
400 Sportsman	01-	23-716ATS*	31,50	23-755ATS	31,50
400 Sportsman L 4x4	94-97	23-716ATS*	31,50	23-717ATS	31,50
400 Xplorer L 4x4	95-99	23-716ATS*	31,50	23-717ATS	31,50
400 Xplorer L 4x4	00-	23-716ATS*	31,50	23-755ATS	31,50
400 Xpress L	96-97	23-716ATS*	31,50	23-717ATS	31,50
425 2x4, 4x4 Magnum	95-98	23-716ATS*	31,50	23-717ATS	31,50
425 Magnum 6x6	96-96	23-716ATS*	31,50	23-717ATS	31,50
425 Magnum 6x6 Middle Axle Brake	96-96	23-756ATS	31,50		
425 Xpedition 4x4	00-	23-716ATS*	31,50	23-755ATS	31,50
450 Outlaw MXR	09-	23-898SI*	31,50	23-642SI	31,50
450 Outlaw S	08-	23-898SI*	31,50	23-642SI	31,50
450 Sportsman	06-	23-716ATS*	31,50	23-787ATS	31,50
455 Diesel EBS 4x4	99-	23-716ATS*	31,50	23-755ATS	31,50
500 ATP HO	04-	23-716ATS*	31,50	23-716ATS*	31,50
500 Scrambler 2x4, 4x4	08-	23-642ATS*	31,50	23-787ATS	31,50
500 Magnum 2x4, 4x4	02-	23-716ATS*	31,50	23-787ATS	31,50
500 Magnum 4x4	00-01	23-716ATS*	31,50	23-755ATS	31,50
500 Outlaw	06-	23-716ATS*	31,50	23-716ATS	31,50
500 Predator	03-	23-716ATS*	31,50	23-716ATS	31,50
500 Predator	06-	23-716ATS*	31,50	23-787ATS	31,50
500 Ranger 2x4	08-	23-897SI*	31,50	23-800ATS	31,50
500 Ranger 4x4	12-	23-897SI*	31,50	23-800ATS	31,50
500 Ranger 6x6	00-02	23-716ATS*	31,50		
500 Revolver	06-	23-642ATS*	31,50	23-642ATS	31,50
500 Scrambler 2x4	01-	23-716ATS*	31,50	23-755ATS	31,50
500 Scrambler 4x4	97	23-716ATS*	31,50	23-717ATS	31,50
500 Scrambler 4x4	98-	23-716ATS*	31,50	23-755ATS	31,50
500 Sportsman 4x4	96-	23-716ATS*	31,50	23-717ATS	31,50
500 Sportsman 6x6	00-	23-716ATS*	31,50	23-757ATS	31,50

POLARIS	Vuosi-malli:	Eteen	Ovh	Taakse	Ovh
500 Sportsman HO (from 16.12.2008)	09-	23-642SI*	31,50	23-899SI	31,50
500 Sportsman HO (to 15.12.2008)	03-08	23-642ATS*	31,50	23-787ATS	31,50
500 Xplorer 4x4	97	23-716ATS*	31,50	23-717ATS	31,50
525 Outlaw	07-	23-898SI*	31,50	23-642SI	31,50
525 Outlaw IRS	08-	23-898SI*	31,50	23-642SI	31,50
525 Outlaw S	08-	23-898SI*	31,50	23-642SI	31,50
550 Sportsman	11-	23-899SI*	31,50	23-899SI	31,50
550 Sportsman EPS	10-	23-899SI*	31,50	23-899SI	31,50
550 Sportsman Touring EPS	10-	23-899SI*	31,50	23-899SI	31,50
550 Sportsman X2	10-	23-899SI*	31,50	23-899SI	31,50
550 Sportsman XP	09-	23-899SI*	31,50	23-899SI	31,50
550 Sportsman XP EPS	09-	23-899SI*	31,50	23-899SI	31,50
570 Ranger RZR EFi	12-	23-898SI*	31,50	23-642SI	31,50
600 Sportsman	03-	23-642ATS*	31,50	23-787ATS*	31,50
700 MVRs 4x4	08-	23-897SI*	31,50	23-897SI	31,50
700 Ranger 4x4 EFi	08-	23-897SI*	31,50	23-897SI	31,50
700 Ranger 6x6 EFi	12-	23-897SI*	31,50	23-800ATS	31,50
700 Sportsman	02-	23-642ATS*	31,50	23-787ATS*	31,50
700 Sportsman MV 700	05-	23-642ATS*	31,50	23-787ATS	31,50
800 MVRs 4x4	08-	23-897SI*	31,50	23-897SI	31,50
800 Ranger 4x4	10-	23-897SI*	31,50	23-897SI	31,50
800 Ranger 6x6	10-	23-897SI*	31,50	23-897SI	31,50
800 Ranger Crew	12-	23-897SI*	31,50	23-897SI	31,50
800 Ranger RZR	08-	23-898SI*	31,50	23-642SI	31,50
800 Ranger RZR S	09-	23-898SI*	31,50	23-642SI	31,50
800 Ranger RZR4	12-	23-897SI*	31,50	23-800ATS	31,50
800 Ranger XP	12-	23-897SI*	31,50	23-800ATS	31,50
800 RZR	08-			23-642ATS	31,50
800 RZR-4	10-			23-800ATS	31,50
800 Sportsman (from 16.12.2008)	09-	23-642SI*	31,50	23-899SI	31,50
800 Sportsman (to 15.12.2008)	05-08	23-642ATS*	31,50	23-787ATS	31,50
850 Scrambler HO / HO EPS	13-	23-899SI*	31,50	23-899SI	31,50
850 Sportsman MV	12-	23-899SI*	31,50	23-899SI	31,50
850 Sportsman Touring EPS	10-	23-899SI*	31,50	23-899SI	31,50
850 Sportsman Touring HO EPS	13-	23-899SI*	31,50	23-899SI	31,50
850 Sportsman X2	11-	23-899SI*	31,50	23-899SI	31,50
850 Sportsman XP	09-	23-899SI*	31,50	23-899SI	31,50
850 Sportsman XP EPS	09-	23-899SI*	31,50	23-899SI	31,50
850 Sportsman XP HO EPS	13-	23-899SI*	31,50	23-899SI	31,50
900 Ranger Diesel	10-	23-897SI*	31,50	23-897SI	31,50
900 Ranger RZR4 XP EFi	12-	23-897SI*	31,50	23-897SI	31,50
900 Ranger RZR4 XP4 EFi	12-	23-897SI*	31,50	23-897SI	31,50

*jarrut 2:lla levyllä/rummulla

SUZUKI	Vuosi-malli:	Eteen	Ovh	Taakse	Ovh
LT 50	84-02			23-2020	19,00
LT-A 50 Quadmaster	01-	23-2101	18,00	23-2017	22,00
LT-Z 50 Quadport	06-	23-2101*	18,00	23-2017	22,00
LT 80	87-06	23-2101*	18,00	23-2104	27,50
LT-Z 90 Quadport	07-	23-2017*	22,00	23-2104	27,50
LT 125	83			23-2107	32,50
LT 125	84-87			23-2016	33,50
LT 160 E	89-92	23-2181*	25,50	23-2016	33,50
LT 185	84-87			23-2016	33,50
LT 230 E	86-93	23-591SI*	31,50	23-592SI	31,50
LT 230 G	85-86	23-2051*	48,00	23-2016	33,50



Vanteet ja renkaat



Talvituoitteet



Vinsit



Laukut ja tuulisuojat



Sähköosat



Jousitus ja voimansiirto



Pakoputket ja suutinsarjat



Ohjaus



Rungon osat ja peitteet



Jarrupalat ja rattaat



Moottori



Variaattorin osat



Maatalous-tarvikkeet



Kärtyt ja reet

ATV





JARRUPALAT JATKUU

SUZUKI	Vuosi-malli:	Eteen	Ovh	Taakse	Ovh
LT 230 S	85-88	23-591SI*	31,50	23-584SI	31,50
LT-F 230	86-87	23-2051*	48,00	23-2016	33,50
LT 250 EF	85-86	23-2051*	48,00	23-2098	48,50
LT 250 R	85-87	23-591SI*	31,50	23-584SI	31,50
LT 250 R	88-94	23-591SI*	31,50	23-649SI	31,50
LT 250 S	89-90	23-591SI*	31,50	23-592SI	31,50
LT-F 250 4WD Quad-runner	97-98	23-2053*	48,00		
LT-F 250	88-01	23-2053*	48,00	23-2110	44,00
LT-F 250 Ozark	03-	23-536SI*	31,50		
LT-Z 250 Quad Sport	04-	23-536SI*	31,50		
LT 300 E	87-89	23-2051*	48,00	23-2098	48,50
LT-F 300	88-90	23-2051	48,00	23-2052	51,50
LT-F 300 King Quad	91-01			23-2052	51,50
LT-F 300 King Quad vasen/taka	02-	23-611SI	31,50	23-2052	51,50
LT-F 300 King Quad oikea	02-	23-638SI	31,50		
LT-A 400 Eiger 2WD/4WD	02-07	23-536SI*	31,50	23-2018	36,50
LT-A 400 King Quad vasen	08-	23-835SI	31,50		
LT-A 400 King Quad oikea	08-	23-836SI	31,50		
LT-F 400 King Quad vasen	08-	23-835SI	31,50		
LT-F 400 King Quad oikea	08-	23-836SI	31,50		
LT-Z 400 Quad Sport	02-	23-592SI*	31,50	23-649SI	31,50
LT-A 450 King Quad vasen	08-	23-835SI	31,50		
LT-A 450 King Quad oikea	08-	23-836SI	31,50		
LT-R 450 vasen/taka	06-	23-611SI	31,50	23-649SI	31,50
LT-R 450 oikea	06-	23-638SI	31,50		
LT 500 R	87-95	23-591SI*	31,50	23-649SI	31,50
LT-A 500 F Vinson	02-	23-536SI*	31,50		
LT-A 500 F Quadmaster vasen	00-	23-611SI	31,50		
LT-A 500 F Quadmaster oikea	00-	23-638SI	31,50		
LT-A 500 King Quad vasen	11-	23-835SI	31,50		
LT-A 500 King Quad oikea	11-	23-836SI	31,50		
LT-F 500 F vasen	98-	23-638SI	31,50		
LT-F 500 F oikea	98-	23-611SI	31,50		
LT-A 700 King Quad vasen	05-	23-835SI	31,50		
LT-A 700 King Quad oikea	05-	23-836SI	31,50		
LT-V 700 Quadrunner Twin Peaks vasen	04-	23-801SI	31,50		
LT-V 700 Quadrunner Twin Peaks oikea	04-	23-798SI	31,50		
LT-A 750 King Quad vasen	08-	23-835SI	31,50		
LT-A 750 King Quad oikea	08-	23-836SI	31,50		

*jarrut 2:lla levyllä/rummulla

YAMAHA	Vuosi-malli:	Eteen	Ovh	Taakse	Ovh
YF 60 S Moto 4	86-86			23-2050	20,00
YT 60 Tri Zinger	84-85			23-2050	20,00
YFM 80 Badger	95-	23-2028*	20,00	23-2034	20,00
YFM 80	87-88	23-2050*	20,00	23-2034	20,00
YFM 90 R Raptor	09-			23-586SI	31,50
YFA-1 125 Breeze	95-	23-2028*	20,00	23-2034	20,00
YT 125 Tri Moto	80-81			23-617LF	31,50
YT 175 Tri Moto	82-83	23-2028	20,00	23-576HF	33,00
YFM 200 Moto 4	85-89	23-2028*	20,00	23-576HF	33,00

YAMAHA	Vuosi-malli:	Eteen	Ovh	Taakse	Ovh
YFS 200 Blaster	88-02	23-2028	20,00	23-637SI	31,50
YFS 200 Blaster	03-	23-536SI*	31,50	23-592SI	31,50
YTM 200 Tri Moto	83-85	23-2028	20,00	23-576HF	33,00
YFM 225 Moto 4	86-88	23-2028*	20,00	23-576HF	33,00
YTM 225 Tri Moto	83-86	23-2028	20,00	23-576HF	33,00
YFM 250 Bruin 2x4	05-	23-536SI*	31,50		
YFM 250 Bear Tracker	01-	23-536SI*	31,50		
YFM 250 Raptor vasen/taka	09-	23-850 SI	31,50	23-592SI	31,50
YFM 250 Raptor oikea	09-	23-849 SI	31,50		
YFM 250 Timberwolf	95	23-2035*	35,50	23-2035	35,50
YFM 250 Moto 4	89-91	23-2035*	35,50	23-576SI	31,50
YFU1W 250 Pro Hauler	89-	23-2035*	35,50	23-2177	20,00
YTZ 250 Tri Moto	85-86	23-575SI	31,50	23-575SI	31,50
YFM 300 Warrior	89	23-536SI	31,50	23-584SI	31,50
YFM 350 Bruin 2x4, 4x4	04-	23-536SI*	31,50		
YFM 350 ER Moto 4	87-88	23-2028*	20,00	23-576HF	33,00
YFM 350 ER Moto 4	89-95	23-2035*	35,50	23-576HF	33,00
YFM 350 Big Bear 2WD	96-98	23-2178*	39,00	23-2066	34,50
YFM 350 Big Bear 2WD	99	23-536SI*	31,50	23-2066	34,50
YFM 350 Big Bear 4WD	99	23-536SI*	31,50	23-2066	34,50
YFM 350 Big Bear	87-88	23-2114*	39,00	23-576HF	33,00
YFM 350 Big Bear	89-95	23-2178*	39,00	23-576HF	33,00
YFM 350 Wolverine (4KB)	95-	23-536SI*	31,50	23-592SI	31,50
YFM 350 R Raptor	04-	23-592SI*	31,50	23-592SI	31,50
YFM 350 Warrior	87-88	23-575SI*	31,50	23-592SI	31,50
YFM 350 Warrior	89-94	23-536SI*	31,50	23-536SI	31,50
YFM 350 Warrior (3GD)	95-96	23-536SI*	31,50	23-592SI	31,50
YFP 350 U Terrapro	88-88	23-2035*	35,50	23-2177	20,00
YFZ 350 Banshee	87-89	23-575SI*	31,50	23-592SI	31,50
YFZ 350 Banshee	90-06	23-536SI*	31,50	23-592SI	31,50
YFM 400 F Kodiak (AJ03)	00-	23-536SI*	31,50	23-754SI	31,50
YFM 400 F Kodiak Automatic	03	23-536SI*	31,50	23-2066	34,50
YFM 400 F Big Bear 4WD (AJ03)	00-	23-536SI*	31,50	23-754SI	31,50
YFM 400 F Big Bear 4WD (VJ06)	00-	23-536SI*	31,50	23-754SI	31,50
YFM 400 Big Bear 2WD (VJ06)	00-	23-536SI*	31,50	23-754SI	31,50
YFM 450 F Kodiak	03-	23-536SI*	31,50	23-754SI	31,50
YFZ 450 S vasen/taka	04-05	23-638SI	31,50	23-592SI	31,50
YFZ 450 S oikea	04-05	23-611SI	31,50		
YFZ 450 S vasen/taka	06-	23-638SI	31,50	23-709SI	31,50
YFZ 450 S oikea	06-	23-611SI	31,50		
YFM 550 Grizzly vasen	09-	23-850 SI	31,50	23-852SI	31,50
YFM 550 Grizzly oikea	09-	23-849 SI	31,50	23-851SI	31,50
YFM 600 F Grizzly (AM03)	98-01	23-592SI*	31,50	23-2066	34,50
YXR 660 Rhino vasen/taka	05-	23-611SI	31,50	23-816SI	31,50
YXR 660 Rhino oikea	05-	23-638SI	31,50		
YFM 660 F Grizzly (AM02)	02-	23-592SI*	31,50	23-799SI	31,50
YFM 660 R Raptor (AM01)	01-	23-592SI*	31,50	23-592SI	31,50
YFM 700 F Grizzly vasen	07-	23-850 SI	31,50	23-852SI	31,50
YFM 700 F Grizzly oikea	07-	23-849 SI	31,50	23-851SI	31,50
YFM 700 R Raptor vasen/taka	06-	23-611SI	31,50	23-816SI	31,50
YFM 700 R Raptor oikea	06-	23-638SI	31,50		
YXR 700 Rhino vasen/taka	08-	23-638SI	31,50	23-638SI	31,50
YXR 700 Rhino oikea/taka	08-	23-611SI	31,50	23-611SI	31,50

*jarrut 2:lla levyllä/rummulla



uutuus!

SX Sintered Off-Road and Supermotard

Huomattavan aggressiivinen jarrupala tuntumaltaan. Suunniteltu kestävämaan hyvinkin korkeita lämpötiloja. Suositellaan motocross ja supermoto käyttöön.

SD Sintered Off-Road

Sintterijarrupala crossiin. Hyvä suorituskyky ja vakaus kaikissa olosuhteissa. Ei niin aggressiivinen tuntumaltaan kuin SX antaen joustavamman hallinnan.

TT Carbon Ceramic, Semi-metallic

Helposti hallittava jarrupala, suunniteltu toimimaan hyvin sekä kuivissa että märissä olosuhteissa. Toimii erityisen jos on huono pito helpon hallinnan ansiosta.



MOTORRAD
BEST BRAND 2014
Kategorie:
Bremsbeläge



GAMMA PASTIGLIE AFTERMARKET AFTERMARKET BRAKE PADS RANGE

	PRESTAZIONI PERFORMANCE	MODULABILITÀ CONTROL	DURATA DURABILITY
OFF-ROAD (front & rear)			
SX	⊙ ⊙ ⊙ ⊙	⊙ ⊙	⊙ ⊙ ⊙ ⊙
SD	⊙ ⊙ ⊙	⊙ ⊙ ⊙	⊙ ⊙ ⊙ ⊙
TT	⊙ ⊙	⊙ ⊙ ⊙ ⊙	⊙ ⊙ ⊙

*Original Equipment Quality

JARRUPALAT SOPIVUUDET

ARCTIC CAT	VM	Tupla-levy	Eteen	Ovh	Taakse	Ovh
50 DVX	06->	On			231-YA2206	32,00
90 DVX	06->	On			231-YA2206	32,00
250 2x4/4x4	99-04	On	231-GR54SD	34,50	231-GR54SD	34,50
250 2x4	05->	On	231-GR53SD	34,50	231-GR53SD	34,50
250 DVX	06-09	On	231-GR5209	32,00		
300 2x4/4x4	98-04	On	231-GR54SD	34,50	231-GR54SD	34,50
300 2x4	10->	On	231-GR53SD	34,50		
300 4x4	05->	On	231-GR53SD	34,50	231-GR53SD	34,50
300 DVX	09->	On	231-GR5209	32,00		
375 2x4/4x4	02->	On	231-GR54SD	34,50	231-GR54SD	34,50
400 2x4/4x4	98-04	On	231-GR54SD	34,50	231-GR54SD	34,50
400 2x4/4x4	05->	On	231-GR53SD	34,50	231-GR53SD	34,50
400 DVX	04->	On	231-H032SD	37,50	231-SU29SD	34,50
400 TBX	04->	On	231-GR54SD	34,50	231-GR54SD	34,50
400 TRV	09->	On	231-GR53SD	34,50	231-GR53SD	34,50
450 H1	10->	On	231-GR53SD	34,50	231-GR53SD	34,50
450 XC	11->	On	231-GR53SD	34,50	231-GR53SD	34,50
454 Arctic Cat 4x4	98->	On	231-GR54SD	34,50	231-GR54SD	34,50
454 Bear Cat 2x4/4x4	96-98	On	231-GR54SD	34,50	231-GR54SD	34,50
500 2x4/4x4	98-04	On	231-GR54SD	34,50	231-GR54SD	34,50
500 2x4/4x4	05->	On	231-GR53SD	34,50	231-GR53SD	34,50
500 TBX 4x4	02-04	On	231-GR54SD	34,50	231-GR54SD	34,50
500 TBX 4x4	05->	On	231-GR53SD	34,50	231-GR53SD	34,50
500 TRV 4x4	03-04	On	231-GR54SD	34,50	231-GR54SD	34,50
500 TRV 4x4	05->	On	231-GR53SD	34,50	231-GR53SD	34,50
550 H1	09->	On	231-GR53SD	34,50	231-GR53SD	34,50

ARCTIC CAT	VM	Tupla-levy	Eteen	Ovh	Taakse	Ovh
550 LTD	09->	On	231-GR53SD	34,50	231-GR53SD	34,50
550 Prowler	09->	On	231-GR53SD	34,50	231-GR53SD	34,50
550 TRV	09->	On	231-GR53SD	34,50	231-GR53SD	34,50
650 H1 4x4	05->	On	231-GR53SD	34,50	231-GR53SD	34,50
650 Prowler	06->	On	231-GR53SD	34,50	231-GR53SD	34,50
650 Twin	05->	On	231-GR53SD	34,50	231-GR53SD	34,50
700 Diesel	06->	On	231-GR53SD	34,50	231-GR53SD	34,50
700 H1	09->	On	231-GR53SD	34,50	231-GR53SD	34,50
700 Prowler	08->	On	231-GR53SD	34,50	231-GR53SD	34,50
700 TBX	12->	On	231-GR53SD	34,50	231-GR53SD	34,50
700 TRV	09->	On	231-GR53SD	34,50	231-GR53SD	34,50
1000 Prowler	09->	On	231-GR53SD	34,50	231-GR53SD	34,50
1000 Thundercat	09->	On	231-GR53SD	34,50	231-GR53SD	34,50
1000 TRV	09->	On	231-GR53SD	34,50	231-GR53SD	34,50
CAN AM	VM	Tupla-levy	Eteen	Ovh	Taakse	Ovh
90 DS X	08->	On	231-KA07SD	32,00	231-KA07SD	32,00
200 Rally 2x4	03-04	On	231-KA0717	26,50		
200 Rally 2x4	05-06	On	231-KA07SD	32,00	231-KS0432	29,50
250 DS Left/Rear	06->	On	231-GR49SD	37,50	231-GR49SD	37,50
250 DS Right	06->	On	231-GR50SD	37,50		
330 Outlander Left/Rear	03->	On	231-GR49SD	37,50	231-GR49SD	37,50
330 Outlander Right	03->	On	231-GR50SD	37,50		
400 Outlander Left/Rear	03-06	On	231-GR49SD	37,50	231-GR49SD	37,50
400 Outlander Left/Rear	07->	On	231-GR49SD	37,50	231-GR50SD	37,50



Vanteet ja renkaat



Talvituotteet



Vinsit



Laukut ja tuulisuojat



Sähköosat



Jousitus ja voimansiirto



Pakoputket ja suutinsarjat



Ohjaus



Rungon osat ja peitteet



Jarrupalat ja rattaat



Moottori



Variaattorin osat



Maatalous-tarvikkeet



Kärryt ja reet

ATV





CAN AM	VM	Tupla-levy	Eteen	Ovh	Taakse	Ovh
400 Outlander Right	03->	On	231-GR50SD	37,50		
500 Outlander Left/Rear	13->	On	231-GR26SD	37,50	231-GR25SD	37,50
500 Outlander Right	13->	On	231-GR27SD	37,50		
500 Renegade Left	12->	On	231-GR26SD	37,50	231-GR26SD	37,50
500 Renegade Right	12->	On	231-GR27SD	37,50	231-GR27SD	37,50
500 Quest Left/Rear	02->	On	231-GR49SD	37,50	231-GR49SD	37,50
500 Quest Right	02->	On	231-GR50SD	37,50		
500 Traxter	99-00	On	231-BB2035	31,00	231-BB2035	31,00
500 Traxter Left/Rear	01->	On	231-GR49SD	37,50	231-GR49SD	37,50
500 Traxter Right	01->	On	231-GR50SD	37,50		
500 Traxter Max Left/Rear	03-05	On	231-GR49SD	37,50	231-GR50SD	37,50
500 Traxter Max Right	03-05	On	231-GR50SD	37,50		
650 DS Left/Rear	01->	On	231-GR49SD	37,50	231-GR49SD	37,50
650 DS Right	01->	On	231-GR50SD	37,50		
650 Outlander Left/Rear	13->	On	231-GR26SD	37,50	231-GR25SD	37,50
650 Outlander Right	13->	On	231-GR27SD	37,50		
650 Quest Left/Rear	02->	On	231-GR49SD	37,50	231-GR49SD	37,50
650 Quest Right	02->	On	231-GR50SD	37,50		
650 Quest Max Left/Rear	03->	On	231-GR49SD	37,50	231-GR50SD	37,50
650 Quest Max Right	03->	On	231-GR50SD	37,50		
650 Traxter Max Left/Rear	03-05	On	231-GR49SD	37,50	231-GR50SD	37,50
650 Traxter Max Right	03-05	On	231-GR50SD	37,50		
800 Outlander Left/Rear	06-11	On	231-GR49SD	37,50	231-GR49SD	37,50
800 Outlander Right	06-11	On	231-GR50SD	37,50		
800 Outlander Left/Rear	12->	On	231-GR26SD	37,50	231-GR25SD	37,50
800 Outlander Right	12->	On	231-GR27SD	37,50		
800 Renegade Left	12->	On	231-GR26SD	37,50	231-GR26SD	37,50
800 Renegade Right	12->	On	231-GR27SD	37,50	231-GR27SD	37,50
1000 Outlander Left/Rear	12->	On	231-GR26SD	37,50	231-GR25SD	37,50
1000 Outlander Right	12->	On	231-GR27SD	37,50		
1000 Renegade Left	12->	On	231-GR26SD	37,50	231-GR26SD	37,50
1000 Renegade Right	12->	On	231-GR27SD	37,50	231-GR27SD	37,50

HONDA	VM	Tupla-levy	Eteen	Ovh	Taakse	Ovh
ATC 200 X	83-85	Ei	231-HO32SD	37,50		
ATC 250 R	81->	Ei	231-HO0906	23,50		
TRX 250 EX SPORTRAX	01-08	On	231-HO32SD	37,50		
TRX 250 R	86-89	Ei	231-HO2506	32,00		
TRX 250 X	08->	On	231-HO32SD	37,50		
TRX 250 X Fourtrax	87-	On	231-HO2506	32,00		
TRX 300 EX SPORTRAX	01-08	On	231-HO32SD	37,50	231-HO32SD	37,50
TRX 300 X	09->	On	231-HO32SD	37,50	231-HO32SD	37,50
ATC 350 X	86->	Ei	231-HO2506	32,00		
TRX 400 EX SPORTRAX	99-08	On	231-HO32SD	37,50	231-HO32SD	37,50
TRX 400 X	09->	On	231-HO32SD	37,50	231-HO32SD	37,50
TRX 420 FA / FPA	09->	On	231-HO32SD	37,50	231-HO55SD	69,00

HONDA	VM	Tupla-levy	Eteen	Ovh	Taakse	Ovh
TRX 420 FPE / FPM	09->	On	231-HO32SD	37,50		
TRX 450 EX SPORTRAX	01->	On	231-HO32SD	37,50	231-HO32SD	37,50
TRX 450 R	04->	Ei	231-HO55SD	69,00		
TRX 450 X	04->	Ei	231-KA07SD	32,00	231-HO48SD	37,50
TRX 500	05->	Ei	231-HO58SD	48,50		
TRX 650 FA Rincon	03-05	On			231-HO55SD	69,00
TRX 650 FGA Rincon	04-05	On			231-HO55SD	69,00
TRX 680 FA6 Rincon	06->	On	231-HO55SD	69,00	231-HO55SD	69,00
TRX 680 FGA6 Rincon	06->	On	231-HO55SD	69,00	231-HO55SD	69,00
TRX 700 INTEGRA	12->	Ei	231-HO57SA	62,00	231-HO36SP	45,50
TRX 700 XX	08->	On	231-KA07SD	32,00	231-HO58SD	48,50

KAWASAKI	VM	Tupla-levy	Eteen	Ovh	Taakse	Ovh
KFX 250 Mojave	87->	On			231-HO32SD	37,50
KEF 300 Lakota	95->	On			231-HO32SD	37,50
KLF 300 Bayou	88->	On	231-KS0432	29,50		
KLF 300 Bayou Left	89->	On	231-YA21SD	37,50		
KLF 300 Bayou Right	89->	On	231-YA22SD	34,50		
KVF 300 Brute Force	13->	Ei	231-HO0906	23,50	231-GR5209	32,00
KFX 400	02->	On	231-HO0906	23,50	231-SU29SD	34,50
KLF 400 Bayou Left	93-99	Ei	231-YA21SD	37,50		
KLF 400 Bayou Right	93-99	Ei	231-YA22SD	34,50		
KVF 400 Prairie	97-98	On	231-HO0906	23,50		
KVF 400 Prairie 2x4	99->	On	231-HO0906	23,50		
KVF 400 Prairie 4x4	99->	On	231-HO0906	23,50		
KFX 450 Left	07->	On	231-KA25SD	37,50	231-HO32SD	37,50
KFX 450 Right	07->	On	231-KA24SD	37,50		
KVF 650 Left	01-03	Ei	231-KA25SD	37,50		
KVF 650 Right	01-03	Ei	231-KA24SD	37,50		
KVF 650 Brute Force Left	05->	On	231-YA21SD	37,50		
KVF 650 Brute Force Right	05->	On	231-YA22SD	34,50		
KFX 700 V-Force Left	04->	Ei	231-KA25SD	37,50		
KFX 700 V-Force Right	04->	Ei	231-KA24SD	37,50		
KVF 700 Prairie Left	04->	Ei	231-KA25SD	37,50		
KVF 700 Prairie Right	04->	Ei	231-KA24SD	37,50		
KVX 700 Left	04->	Ei	231-KA25SD	37,50		
KVX 700 Right	04->	Ei	231-KA24SD	37,50		
KRF 750 Teryx Left	08->	On	231-YA21SD	37,50		
KRF 750 Teryx Right	08->	On	231-YA22SD	34,50		
KVF 750 Brute Force Left	05->	Ei	231-YA22SD	34,50		
KVF 750 Brute Force Right	05->	Ei	231-YA21SD	37,50		

KTM	VM	Tupla-levy	Eteen	Ovh	Taakse	Ovh
450 XC	08->	On	231-GR07SD	41,50	231-GR08SD	37,50
505 XC	08->	On	231-GR07SD	41,50	231-GR08SD	37,50



KYMCO	VM	Tupla-levy	Eteen	Ovh	Taakse	Ovh
300 MAXXER	06->	Ei	231-GR5209	32,00		
300 MXU	06->	Ei	231-GR5209	32,00	231-GR5209	32,00
400 MAXXER	09->	On	231-GR53SD	34,50	231-GR53SD	34,50
400 MXU	08->	On	231-GR53SD	34,50	231-GR53SD	34,50
450 MAXXER	09->	On	231-GR53SD	34,50	231-GR53SD	34,50
450 MXU i	13->	On	231-GR5209	32,00	231-GR5209	32,00
500 MXU	06->	On	231-GR5209	32,00	231-GR5209	32,00
500 UXV	08->	On	231-GR5209	32,00	231-GR5209	32,00
POLARIS	VM	Tupla-levy	Eteen	Ovh	Taakse	Ovh
200 Phoenix	05->	On	231-PO02SD	34,50	231-KS0432	29,50
200 Sawtooth	06->	On	231-KA07SD	32,00	231-KA07SD	32,00
250 2x4, 4x4	90->	On	231-PO02SD	34,50	231-PO03SD	34,50
250 2x4, 4x4	93->	On	231-PO02SD	34,50	231-PO03SD	34,50
250 Big Boss 4x6, 6x6	89-93	On	231-PO02SD	34,50	231-PO03SD	34,50
250 Big Boss 4x6, 6x6 Middle Axle Brake	89-93	On	231-PO03SD	34,50		
250 Trail Blazer	94-98	On	231-PO02SD	34,50	231-PO03SD	34,50
250 Trail Blazer	99->	On	231-PO02SD	34,50	231-PO04SD	34,50
250 Trail Boss	88-90	On	231-PO01SD	34,50		
250 Trail Boss	91-99	On	231-PO02SD	34,50	231-PO03SD	34,50
250 Trail Boss 2x4, 4x4	91-92	On	231-PO02SD	34,50	231-PO03SD	34,50
250 Xplorer 4x4	00->	On	231-PO02SD	34,50	231-PO04SD	34,50
300 2x4, 4x4	94-95	On	231-PO02SD	34,50	231-PO03SD	34,50
300 Big Boss 6x6	94->	On	231-PO02SD	34,50	231-PO03SD	34,50
300 Big Boss 6x6 Middle Axle Brake	94->	On	231-PO03SD	34,50		
300 Hawkeye 2x4/4x4	06->	On	231-PO02SD	34,50	231-PO02SD	34,50
300 Sportsman 4x4	08->		231-PO01SD	34,50	231-PO01SD	34,50
300 Xplorer 4x4	96->	On	231-PO02SD	34,50	231-PO03SD	34,50
300 Xpress 2x4	98->	On	231-PO02SD	34,50	231-PO03SD	34,50
300 Xpress L	96-97	On	231-PO02SD	34,50	231-PO03SD	34,50
325 Magnum 2x4, 4x4	00-02	On	231-PO02SD	34,50	231-PO04SD	34,50
325 Trail Boss	00-02	On	231-PO02SD	34,50	231-PO04SD	34,50
325 Xpedition	00-01	On	231-PO01SD	34,50	231-PO04SD	34,50
325 Xpedition	02->	On	231-PO01SD	34,50	231-PO06SD	45,50
330 ATP	04-05	On	231-PO02SD	34,50	231-PO02SD	34,50
330 ATP	06->	On	231-PO02SD	34,50	231-PO06SD	45,50
330 E TRIAL BLAZER	08->	On	231-PO01SD	34,50	231-PO06SD	45,50
330 Magnum 2x4, 4x4	03->	On	231-PO02SD	34,50	231-PO06SD	45,50
330 Trail Boss	03->	On	231-PO02SD	34,50	231-PO04SD	34,50
335 Sportsman 4x4	99->	On	231-PO02SD	34,50	231-PO04SD	34,50
350 Big Boss	93->	On	231-PO02SD	34,50	231-PO03SD	34,50
350 Big Boss Middle Axle Brake	93->	On	231-PO03SD	34,50		
350 L 2x4, 4x4	90->	On	231-PO02SD	34,50	231-PO03SD	34,50
350 L 4x4	93->	On	231-PO02SD	34,50	231-PO03SD	34,50
350 Sportsman 4x4	93->	On	231-PO02SD	34,50	231-PO03SD	34,50
350 Trail Boss L 2x4	91-93	On	231-PO02SD	34,50	231-PO03SD	34,50
350 Trail Boss L 4x4	91->	On	231-PO02SD	34,50	231-PO03SD	34,50
400 Big Boss L 6x6	96->	On	231-PO02SD	34,50	231-PO03SD	34,50
400 L 2x4	94-95	On	231-PO02SD	34,50	231-PO03SD	34,50
400 L 4x4	94->	On	231-PO02SD	34,50	231-PO03SD	34,50
400 Scrambler 2x4, 4x4	00->	On	231-PO02SD	34,50	231-PO04SD	34,50
400 Scrambler 4x4	98-98	On	231-PO02SD	34,50	231-PO03SD	34,50
400 Scrambler 4x4	99->	On	231-PO02SD	34,50	231-PO04SD	34,50
400 Scrambler L 4x4	95-97	On	231-PO02SD	34,50	231-PO03SD	34,50
400 Sport	99-00	On	231-PO02SD	34,50	231-PO04SD	34,50

POLARIS	VM	Tupla-levy	Eteen	Ovh	Taakse	Ovh
400 Sport L	94-98	On	231-PO02SD	34,50	231-PO03SD	34,50
400 Sportsman	01->	On	231-PO02SD	34,50	231-PO04SD	34,50
400 Sportsman L 4x4	94-97	On	231-PO02SD	34,50	231-PO03SD	34,50
400 Trail Blazer	03->	On	231-PO02SD	34,50	231-PO04SD	34,50
400 Xplorer L 4x4	95-99	On	231-PO02SD	34,50	231-PO03SD	34,50
400 Xplorer L 4x4	00->	On	231-PO02SD	34,50	231-PO04SD	34,50
400 Xpress L	96-97	On	231-PO02SD	34,50	231-PO03SD	34,50
425 2x4, 4x4 Magnum	95-98	On	231-PO02SD	34,50	231-PO03SD	34,50
425 Magnum 6x6	96->	On	231-PO02SD	34,50	231-PO04SD	34,50
425 Xpedition 4x4	00->	On	231-PO02SD	34,50	231-PO04SD	34,50
450 Sportsman	06->	On	231-PO02SD	34,50	231-PO06SD	45,50
450 Outlaw MXR	09->	On	231-PO09SD	48,00	231-PO01SD	34,50
450 Outlaw S	08->	On	231-PO09SD	48,00	231-PO01SD	34,50
455 Diesel EBS 4x4	99->	On	231-PO02SD	34,50	231-PO04SD	34,50
500 ATP HO	04->	On	231-PO02SD	34,50	231-PO02SD	34,50
500 Big Boss 6x6	98-99	On	231-PO02SD	34,50	231-PO03SD	34,50
500 Big Boss 6x6 Middle Axle Brake	98-99	On	231-PO03SD	34,50		
500 Magnum 2x4, 4x4	02->	On	231-PO02SD	34,50	231-PO06SD	45,50
500 Magnum 4x4	00-01	On	231-PO02SD	34,50	231-PO04SD	34,50
500 Outlaw	06->	On	231-PO02SD	34,50	231-PO02SD	34,50
500 Predator	03->	On	231-PO02SD	34,50	231-PO02SD	34,50
500 Predator e	06->	On	231-PO02SD	34,50	231-PO06SD	45,50
500 Ranger 2x4	08->	On	231-PO10SD	48,00	231-PO07SD	48,50
500 Ranger 4x4	12->	On	231-PO10SD	48,00	231-PO07SD	48,50
500 Ranger 6x6	00-02	On	231-PO02SD	34,50		
500 Revolver	06->	On	231-PO01SD	34,50	231-PO01SD	34,50
500 Scrambler	08->	On	231-PO01SD	34,50	231-PO06SD	45,50
500 Scrambler 2x4	01->	On	231-PO02SD	34,50	231-PO04SD	34,50
500 Scrambler 4x4	97-97	On	231-PO02SD	34,50	231-PO03SD	34,50
500 Scrambler 4x4	98->	On	231-PO02SD	34,50	231-PO04SD	34,50
500 Sportsman 4x4	96->	On	231-PO02SD	34,50	231-PO03SD	34,50
500 Sportsman 6x6	00->	On	231-PO02SD	34,50		
500 Sportsman HO	03->	On	231-PO01SD	34,50	231-PO06SD	45,50
500 Xplorer 4x4	97->	On	231-PO02SD	34,50	231-PO03SD	34,50
525 Outlaw	07->	On	231-PO09SD	48,00	231-PO01SD	34,50
525 Outlaw IRS	08->	On	231-PO09SD	48,00	231-PO01SD	34,50
525 Outlaw S	08->	On	231-PO09SD	48,00	231-PO01SD	34,50
550 Sportsman ,X2, XP, Touring	09->	On	231-PO11SD	48,00	231-PO11SD	48,00
570 Ranger RZR Efi	12->	On	231-PO09SD	48,00	231-PO01SD	34,50
600 Sportsman	03->	On	231-PO01SD	34,50	231-PO06SD	45,50
700 MVRS 4x4	08->	On	231-PO10SD	48,00	231-PO10SD	48,00
700 Ranger 4X4	08->	On	231-PO10SD	48,00	231-PO10SD	48,00
700 Ranger 6X6	12->	On	231-PO10SD	48,00	231-PO07SD	48,50
700 Sportsman	02->	On	231-PO01SD	34,50	231-PO06SD	45,50
700 Sportsman MV 700	05->	On	231-PO01SD	34,50	231-PO06SD	45,50
800 MVRS 4x4	08->	On	231-PO10SD	48,00	231-PO10SD	48,00
800 RZR	08->	On	231-PO01SD	34,50		
800 Ranger RZR	08->	On	231-PO09SD	48,00	231-PO01SD	34,50
800 Ranger RZR S	09->	On	231-PO09SD	48,00	231-PO01SD	34,50
800 Ranger 4x4	10->	On	231-PO10SD	48,00	231-PO10SD	48,00
800 Ranger 6x6 Efi	10->	On	231-PO10SD	48,00	231-PO10SD	48,00
800 Ranger crew	12->	On	231-PO10SD	48,00	231-PO10SD	48,00
800 Ranger RZR4 Efi	12->	On	231-PO10SD	48,00	231-PO07SD	48,50
800 Ranger XP	12->	On	231-PO10SD	48,00	231-PO07SD	48,50
800 Sportsman	05->	On	231-PO01SD	34,50	231-PO06SD	45,50
850 Scrambler	13->	On	231-PO11SD	48,00	231-PO11SD	48,00



Vanteet ja renkaat



Talvituotteet



Vinsit



Laukut ja tuulisuojat



Sähköosat



Jousitus ja voimansiirto



Pakoputket ja suutinsarjat



Ohjauksen osat



Runnon osat ja peitteet



Jarrupalat ja rattaat



Moottori



Variaattorin osat



Maatalous-tarvikkeet



Kärryt ja reet



ATV



ATV

-  Vanteet ja renkaat
-  Talvituotteet
-  Vinssit
-  Laukut ja tuulisuojat
-  Sähköosat
-  Jousitus ja voimansiirto
-  Pakoputket ja suutinsarjat
-  Ohjaus
-  Rungon osat ja peitteet
-  Jarrupalat ja ratat
-  Moottori
-  Variaattorin osat
-  Maatalous-tarvikkeet
-  Kärryt ja reet

POLARIS	VM	Tupla-levy	Eteen	Ovh	Taakse	Ovh
850 Sportsman MV	12->	On	231-PO11SD	48,00	231-PO11SD	48,00
850 Sportsman, XP, X2, Touring, HO	09->	On	231-PO11SD	48,00	231-PO11SD	48,00
900 Ranger 4x4 diesel	10->	On	231-PO10SD	48,00	231-PO10SD	48,00
900 Ranger RZR4 XP, XP4	12->	On	231-PO10SD	48,00	231-PO10SD	48,00
EV-LSV	10->	On	231-PO10SD	48,00	231-PO07SD	48,50
LSV 4x4	11->	On	231-PO10SD	48,00	231-PO07SD	48,50
MV DIESEL CREW	13->	On	231-PO10SD	48,00	231-PO10SD	48,00
Ranger 48v EV	13->	On	231-PO10SD	48,00	231-PO07SD	48,50
Ranger 2x4, 4x4, 6x6	02->	On	231-PO07SD	48,50	231-PO07SD	48,50
Ranger XP	06->	On	231-PO07SD	48,50	231-PO07SD	48,50
Trail Blazer	90-93	On	231-PO02SD	34,50	231-PO03SD	34,50
Trail Boss 2x4, 4x4	88-89	On	231-PO02SD	34,50	231-PO03SD	34,50

SUZUKI	VM	Tupla-levy	Eteen	Ovh	Taakse	Ovh
LT 230 S	86-93	Ei	231-KS0432	29,50		
LT 230 E	86-93	On			231-HO32SD	37,50
LT 250 R	85-87	On	231-KS0432	29,50	231-YA21SD	37,50
LT 250 R	88-94	Ei	231-KS0432	29,50	231-SU29SD	34,50
LT 250 S	89-90	On			231-HO32SD	37,50
LT-Z 250 Quad Sport	04->	Ei	231-HO0906	23,50		
LT-A 400 Eiger 2WD/4WD	02->	On	231-HO0906	23,50		
LT-F 400 Eiger 2WD/4WD	02->	On	231-HO0906	23,50		
LT-Z 400 Quad Sport	02->	On	231-HO0906	23,50	231-SU29SD	34,50
LT-A 400 King Quad Left	08->	On	231-GR73SD	37,50		
LT-A 400 King Quad Right	08->	On	231-GR74SD	37,50		
LT-R 450 Right	06->	On	231-YA22SD	34,50		
LT-R 450 Left	06->	On	231-YA21SD	37,50	231-SU29SD	34,50
LT 500 R	87-95	On			231-SU29SD	34,50
LT 500 R	88->	On	231-KA0717	26,50		
LT-A 400 F Quad-master Left	00->	On	231-YA21SD	37,50		
LT-A 400 F Quad-master Right	00->	On	231-YA22SD	34,50		
LT-A 500 King Quad Left	11->	Ei	231-GR73SD	37,50		
LT-A 500 King Quad Right	11->	Ei	231-GR74SD	37,50		
LT-A 500 Vinson	02->	On	231-HO0906	23,50		
LT-F 500 F Left	98->	On	231-YA22SD	34,50		
LT-F 500 F Right	98->	On	231-YA21SD	37,50		
LT-A 700 King Quad Left	05->	Ei	231-GR73SD	37,50		
LT-A 700 King Quad Right	05->	Ei	231-GR74SD	37,50		
LT-V 700 Quad-runner Twin Peaks Left	04->	Ei	231-KA25SD	37,50		
LT-V 700 Quad-runner Twin Peaks Right	04->	Ei	231-KA24SD	37,50		
LT-A 750 King Quad Left	08->	On	231-GR73SD	37,50		
LT-A 750 King Quad Right	08->	On	231-GR74SD	37,50		

YAMAHA	VM	Tupla-levy	Eteen	Ovh	Taakse	Ovh
YFS 200 R Blaster	03->	On	231-HO0906	23,50	231-HO32SD	37,50
YFM 250 Bruin	05->	On	231-HO0906	23,50		
YFM 250 Bear Tracker	01->	Ei	231-HO0906	23,50		
YFM 250 Raptor Left/Rear	09->	On	231-YA49SD	47,50	231-HO32SD	37,50

YAMAHA	VM	Tupla-levy	Eteen	Ovh	Taakse	Ovh
YFM 250 Raptor Right	09->	On	231-YA48SD	47,50		
YTZ 250 Tri Moto	85-86	On	231-YA1407	32,00	231-YA1407	32,00
YFM 350 Bruin 2x4, 4x4	04->	On	231-HO0906	23,50		
YFM 350 Big Bear 4x4	99->	On	231-HO0906	23,50		
YFM 350 Wolverine	95-96	On	231-HO0906	23,50	231-HO32SD	37,50
YFM 350 R RAPTOR	04->	On	231-HO32SD	37,50	231-HO32SD	37,50
YFM 350 Warrior	87-88	On	231-YA1407	32,00	231-HO32SD	37,50
YFM 350 Warrior	89-94	On	231-HO0906	23,50	231-HO0906	23,50
YFM 350 Warrior (3GD)	95-96	On	231-HO0906	23,50	231-HO32SD	37,50
YFZ 350 Banshee	87-89	On	231-YA1407	32,00	231-HO32SD	37,50
YFZ 350 Banshee	90-06	On	231-HO0906	23,50	231-HO32SD	37,50
YFM 400 F Kodiak	00->	On	231-HO0906	23,50	231-GR49SD	37,50
YFM 400F Big Bear 4WD	00->	On	231-HO0906	23,50	231-GR49SD	37,50
YFM 400 Big Bear 2WD	00->	On	231-HO0906	23,50	231-GR49SD	37,50
YFM 450 F Kodiak	03->	On	231-HO0906	23,50	231-GR49SD	37,50
YFM 450 Wolverine	06->	On	231-HO0906	23,50	231-GR49SD	37,50
YXR 450 RhiEi Left/Rear	06->	On	231-YA21SD	37,50	231-GR74SD	37,50
YXR 450 RhiEi Right	06->	On	231-YA22SD	34,50		
YZF 450 S Left/Rear	04-05	On	231-YA22SD	34,50	231-HO32SD	37,50
YZF 450 S Right	04-05	On	231-YA21SD	37,50		
YFM 550 F Grizzly Left	09->	On	231-YA49SD	47,50	231-YA51SD	47,50
YFM 550 F Grizzly Right	09->	On	231-YA48SD	47,50	231-YA50SD	47,50
YFM 600 F Grizzly	98-01	On	231-HO32SD	37,50		
YFM 660 F Grizzly	02->	On	231-HO32SD	37,50	231-YA45SD	45,50
YFM 660 R Raptor	01->	On	231-HO32SD	37,50	231-HO32SD	37,50
YFM 700 F Grizzly Right	07->	On	231-YA48SD	47,50	231-YA50SD	47,50
YFM 700 F Grizzly Left	07->	On	231-YA49SD	47,50	231-YA51SD	47,50
YFM 700 R Raptor Left/Rear	06->	On	231-YA21SD	37,50	231-GR74SD	37,50
YFM 700 R Raptor Right	06->	On	231-YA22SD	34,50		
YXR 700 RhiEi Right/Rear	08->	Ei	231-YA21SD	37,50	231-YA21SD	37,50
YXR 700 RhiEi Left/Rear	08->	Ei	231-YA22SD	34,50	231-YA22SD	34,50

JARRUPALAT



uutuus!



ProX jarrupalat

- Sintterijarrupaloilla erinomainen pysähtyvyys ja kulutuskestävyys
- Takapaloissa kovempi seos kuin etupaloissa

Hinta: 20,- / srj

E-TON	Vuosi	Eteen	Taakse
Viper 50 RXL	2003-2007	-	400-37-106002
Draco 50 BXL	2005-2006	-	400-37-106002
Viper 70 RXL	2005-2007	-	400-37-106002
Viper 90 RXL	2003-2007	-	400-37-106002
Draco 100 BXL	2005-2006	-	400-37-106002
Viper 150 EXL	2005-2007	400-37-106002	-
Viper 150	2005-2006	400-37-204302	-
Vector 250 VXL	2006-2007	400-37-106002	-
Vector 300 VXL	2007	400-37-106002	-

GAS GAS	Vuosi	Eteen	Taakse
50 Wild HP	2004-2007	400-37-102202	400-37-102202
250 Wild HP	2003-2008	400-37-102202	400-37-102202
300 Wild HP	2003-2008	400-37-102202	400-37-102202
450 Wild HP	2004-2009	400-37-102202	400-37-102202
515 Wild HP	2009	400-37-102202	400-37-102202

HONDA	Vuosi	Eteen	Taakse
ATC200X	1983-1987	400-37-207002	400-37-207002
ATC250R	1981	400-37-202002	-
ATC250R	1982	400-37-202002	400-37-207002
ATC250R	1983-1984	400-37-207002	400-37-207002
TRX250X Fourtrax	1987-1992	400-37-207002	400-37-207002
TRX250EX	2001-2008	400-37-207002	-
TRX250X	2009-2014	400-37-207002	-
TRX300EX	1993-2008	400-37-207002	400-37-207002
TRX300X	2009	400-37-207002	400-37-207002
TRX400EX	1999-2008	400-37-207002	400-37-207002
TRX400X	2009-2014	400-37-207002	400-37-207002
TRX420 Rancher	2007-2014	400-37-207002	-
TRX450R	2004-2014	400-37-103202	400-37-208502
TRX500 Rubicon	2005-2006	400-37-207002	-
TRX650F Rincon	2003-2005	-	400-37-208502
TRX680F Rincon	2006-2014	-	400-37-208502
TRX700XX	2008-2011	400-37-103202	-

KAWASAKI	Vuosi	Eteen	Taakse
KXF250 Tecate	1987-1988	-	400-37-207002
KSF250 Mojave	1987-2004	-	400-37-207002
KEF300 Lakota	1995-2003	-	400-37-207002
KVF300 Prairie	1999-2002	400-37-202002	-
KVF360 Prairie	2003-2013	400-37-202002	-
KVF400 Prairie	1997-2002	400-37-202002	-
KFX400	2003-2006	400-37-207002	400-37-207402
KFX450R (Left)	2008-2014	400-37-209402	400-37-207002
KFX450R (Right)	2008-2014	400-37-106202	-
KVF650 Brute Force (Left)	2005-2013	400-37-209402	-
KVF650 Brute Force (Right)	2005-2013	400-37-106202	-

KAWASAKI	Vuosi	Eteen	Taakse
KFX700 (Left)	2004-2009	400-37-209402	-
KFX700 (Right)	2004-2009	400-37-106202	-
KVF700 Prairie (Left)	2004-2006	400-37-209402	-
KVF700 Prairie (Right)	2004-2006	400-37-106202	-
KVF750 Brute Force (Left)	2004-2014	400-37-204302	-
KVF750 Brute Force (Right)	2004-2014	400-37-100202	-

KTM	Vuosi	Eteen	Taakse
450 XC ATV	2008-2009	400-37-217102	400-37-227102
450 SX ATV	2009-2010	400-37-217102	400-37-227102
505 SX ATV	2009-2010	400-37-217102	400-37-227102
525 XC ATV	2008-2011	400-37-217102	400-37-227102
525 XC ATV	2012	400-37-217102	-

POLARIS	Vuosi	Eteen	Taakse
Trail Blazer 250	1990-1998	400-37-206402	400-37-204402
Trail Blazer 250	1999-2004	400-37-206402	400-37-201402
Trail Blazer 250	2005-2006	400-37-206402	400-37-209502
Trail Boss 250	1985-1999	400-37-206402	400-37-204402
Trail Boss 250 4x4	1987-1993	400-37-206402	400-37-204402
Xplorer 250 4x4	2000-2002	400-37-206402	400-37-201402
Sportsman 300 4x4	2008-2010	400-37-206402	400-37-206402
Trail Blazer 330	2008-2013	400-37-206402	400-37-209502
Trail Boss 330	2003-2004	400-37-206402	400-37-201402
Trail Boss 330	2005-2012	400-37-206402	400-37-209502
Scrambler 400 4x4	1995-1997	400-37-206402	400-37-204402
Scrambler 400 4x4	1998-2002	400-37-206402	400-37-201402
Sport 400	1994-1998	400-37-206402	400-37-204402
Sport 400	1999	400-37-206402	400-37-201402
Sportsman 400 4x4	1994-1997	400-37-206402	400-37-204402
Sportsman 400 4x4	1998-2005	400-37-206402	400-37-209502
Sportsman 400 HO 4x4	2008-2013	400-37-206402	400-37-206402
Xplorer 400L 4x4	1995-1998	400-37-206402	400-37-204402
Xplorer 400L 4x4	1999-2002	400-37-206402	400-37-201402
450 MXR Outlaw	2008-2010	400-37-167102	400-37-206402
Scrambler 500 4x4	1997	400-37-206402	400-37-204402
Scrambler 500 4x4	1998-2012	400-37-206402	400-37-201402
Sportsman 500 4x4	1996-1997	400-37-206402	400-37-204402
Sportsman 500 4x4	1998-2002	400-37-206402	400-37-201402
Sportsman 500 HO 4x4	2001-2002	400-37-206402	400-37-201402
Sportsman 500 HO 4x4	2003-2008	400-37-206402	400-37-209502
Sportsman 500	2008-2012	400-37-206402	-
525 Outlaw	2008-2011	400-37-167102	400-37-206402
Sportsman 800 EFI	2005-2014	400-37-206402	400-37-209502



Vanteet ja renkaat



Talvituotteet



Vinsit



Laukut ja tuulisuojat



Sähköosat



Jousitus ja voimansiirto



Pakoputket ja suutinsarjat



Ohjaukset



Rungon osat ja peitteet



Jarrupalat ja rattaat



Moottori



Variaattorin osat



Maatalous-tarvikkeet



Kärryt ja reet

ATV





Vanteet ja renkaat



Talvituotteet



Vinssit



Laukut ja tuulisuojat



Sähköosat



Jousitus ja voimansiirto



Pakoputket ja suutinsarjat



Ohjaus



Rungon osat ja peitteet



Jarrupalat ja rattaat



Moottori



Variaattorin osat



Maatalous-tarvikkeet



Kärryt ja reet

JARRUPALAT SOPIVUUDET JATKUU



SUZUKI	Vuosi	Eteen	Taakse
LT-F250 Ozark	2002-2013	400-37-202002	-
LT-Z250 Quadsport	2004-2009	400-37-207002	-
LT-F300F King Quad (Left)	1999-2002	400-37-100202	-
LT-F300F King Quad (Right)	1999-2002	400-37-204302	-
LT-A400 Eiger	2002-2007	400-37-202002	-
LT-A/F400 King Quad (Left)	2008-2013	400-37-236102	-
LT-A/F400 King Quad (Right)	2008-2013	400-37-246102	-
LT-Z400	2003-2014	400-37-207002	400-37-207402
LT-A450X King Quad (Left)	2007-2010	400-37-236102	-
LT-A450X King Quad (Right)	2007-2010	400-37-246102	-
LT-R450 (Left)	2006-2011	400-37-100202	400-37-207402
LT-R450 (Right)	2006-2011	400-37-204302	-
LT-A/F500F Vinson	2002-2007	400-37-202002	400-37-105002
LT-A700X King Quad (Left)	2005-2007	400-37-236102	-
LT-A700X King Quad (Right)	2005-2007	400-37-246102	-
LT-V700F Twin Peaks (Left)	2004-2005	400-37-209402	-
LT-V700F Twin Peaks (Right)	2004-2005	400-37-106202	-
LT-A750X King Quad (Left)	2008-2013	400-37-236102	-
LT-A750X King Quad (Right)	2008-2013	400-37-246102	-

YAMAHA	Vuosi	Eteen	Taakse
YFS200 Blaster	2003-2006	400-37-202002	400-37-207002
YFM250 Beartracker	2001-2004	400-37-202002	-
YFM250 Big Bear	2005-2009	400-37-202002	-
YFM250R Raptor (Left)	2008-2013	400-37-255102	400-37-207002
YFM250R Raptor (Right)	2008-2013	400-37-265102	-
YFM350 Bruin	2004-2006	400-37-202002	-
YFM350 Wolverine	1995-2005	400-37-202002	400-37-207002
YFM350 Wolverine	2006-2009	400-37-202002	-
YFM350 Warrior	1989-2004	400-37-202002	400-37-207002
YFM350R Raptor	2005-2013	400-37-207002	400-37-207002
YFM350F Grizzly	2007-2014	400-37-202002	-
YFZ350 Banshee	1987-2006	400-37-202002	400-37-207002
YFZ450 (Left)	2004-2005	400-37-100202	400-37-207002
YFZ450 (Right)	2004-2005	400-37-204302	-
YFZ450 (Left)	2006-2009	400-37-100202	400-37-208002
YFZ450 (Right)	2006-2009	400-37-204302	-
YFZ450	2012-2013	400-37-207002	400-37-208002
YFZ450R (Left)	2009-2014	400-37-100202	400-37-208002
YFZ450R (Right)	2009-2014	400-37-204302	-
YFM550 Grizzly (Left)	2009-2014	400-37-255102	400-37-275102
YFM550 Grizzly (Right)	2009-2014	400-37-265102	400-37-285102
YFM600F Grizzly	1998-2001	400-37-207002	-
YFM660R Raptor	2001-2005	400-37-207002	400-37-207002
YFM660F Grizzly	2002-2008	400-37-207002	-
YXR660 Rhino (Left)	2004-2007	400-37-100202	400-37-226102
YXR660 Rhino (Right)	2004-2007	400-37-204302	-
YFM700R Raptor (Left)	2006-2012	400-37-100202	400-37-226102
YFM700R Raptor (Right)	2006-2012	400-37-204302	-
YFM700R Raptor (Left)	2013-2014	400-37-100202	400-37-208002
YFM700R Raptor (Right)	2013-2014	400-37-204302	-
YFM700F Grizzly (Left)	2007-2014	400-37-255102	400-37-275102
YFM700F Grizzly (Right)	2007-2014	400-37-265102	400-37-285102
YXR700 Rhino (Left)	2008-2013	400-37-204302	400-37-204302
YXR700 Rhino (Right)	2008-2013	400-37-100202	400-37-100202



ATV

JARRUPALAT BRONCO

BRONCO

ATV COMPONENTS

Laadukkaat ja pitkäikäiset jarrupalat Broncolta. Täyttävät kaikki valmistajien vaatimukset ja toimivat erinomaisesti märissä, pölyisissä ja mutaisissa olosuhteissa. Helppo asennus. Eivät sisällä asbestia.



78-05000



78-05011



78-05012



78-05015



78-05016



78-05019



78-05025



78-05026



78-05027



78-05028



78-05029



78-05030



78-05032



78-05032



78-05038



78-05039



78-05057



78-05156



78-05265



78-05286



78-05401



78-05403



78-05404



78-05406



78-05408



78-05411



78-05415



78-05416



78-05419



78-05453



78-05561



78-05562



78-05600



78-05611



78-05612



78-05654



78-05655

ARCTIC CAT	VM	Eteen	Hinta	Taakse	Hinta
250 2X4	99-02	78-05600	24,30	78-05600	24,30
250 4X4	00-02	78-05600	24,30	78-05600	24,30
250 4X4	02-04	78-05600	24,30	78-05600	24,30
250 2X4	99-04	78-05600	24,30	78-05600	24,30
250 4X4	2001	78-05600	24,30	78-05600	24,30
BEAR CAT 250	96-97			78-05600	24,30
250 2X4	2005	78-05026	26,50	78-05026	26,50
300 2X4/4X4	98-01	78-05600	24,30	78-05600	24,30
300 2X4/4X4	1999			78-05600	24,30
300 2X4/4X4	2002	78-05600	24,30	78-05600	24,30
300 2X4/4X4	02-03	78-05600	24,30	78-05600	24,30
300 4X4	2005	78-05026	26,50	78-05026	26,50
300 2X4	2010	78-05026	26,50	78-05026	26,50
375 2X4/4X4 AUTO-MATIC	2002	78-05600	24,30	78-05600	24,30
375	2002	78-05600	24,30	78-05600	24,30
375 2X4/4X4	2002	78-05600	24,30	78-05600	24,30
375 2X4/4X4	2002	78-05600	24,30	78-05600	24,30
400i 2X4/4X4	02-03	78-05600	24,30	78-05600	24,30
400 4X4	98-99	78-05600	24,30	78-05600	24,30
400 2X4/4X4	00-01	78-05600	24,30	78-05600	24,30
400FIS 2X4/4X4	2002	78-05600	24,30	78-05600	24,30
400 4X4	02-03	78-05600	24,30	78-05600	24,30
400 2X4/4X4	98-01	78-05600	24,30	78-05600	24,30
DVX 400	04-08	78-05404	19,30	78-05026	26,50
400 TRV	09-13	78-05026	26,50	78-05026	26,50
400 4X4/FIS (AUTO/MANUEL)	05-08	78-05026	26,50		

ARCTIC CAT	VM	Eteen	Hinta	Taakse	Hinta
PARKING BRAKE		78-05600	24,30	78-05026	26,50
400 ATV CR	13-14	78-05026	26,50	78-05026	26,50
425i /SE	2012	78-05026	26,50	78-05026	26,50
450 TRV 4X4 2up	2010	78-05026	26,50	78-05026	26,50
450 HI	2010	78-05026	26,50	78-05026	26,50
450i	11-12	78-05026	26,50	78-05026	26,50
450 TRV	11-12	78-05026	26,50	78-05026	26,50
450 ATV CR	13-14	78-05026	26,50	78-05026	26,50
XC450i	11-12	78-05026	26,50	78-05026	26,50
450 lxc	13-14	78-05026	26,50	78-05600	24,30
454 2X4	1998	78-05600	24,30	78-05600	24,30
454 2X4/4X4	98-99	78-05600	24,30	78-05600	24,30
BEAR CAT 454 2X4	97-98	78-05600	24,30	78-05600	24,30
454 4X4	1998	78-05600	24,30	78-05600	24,30
500 4X4 (ALL MODELS)	98-04	78-05600	24,30	78-05600	24,30
500 4X4	99-02	78-05600	24,30	78-05600	24,30
500 4X4 AUTOMATIC	2002	78-05600	24,30	78-05600	24,30
500 FIS	2002	78-05600	24,30	78-05026	26,50
500 FIS (AUTO/MANUEL)	05-09	78-05026	26,50		
PARKING BRAKE		78-05600	24,30		
500 TBX 4X4	2002	78-05600	24,30	78-05600	24,30
500 TRV/TBX AUTO	05-09	78-05026	26,50	78-05026	26,50
PARKING BRAKE		78-05600	24,30		
500 4X4	98-01	78-05600	24,30	78-05600	24,30
500 4x4 AUTO UTILITY	05-08	78-05026	26,50	78-05026	26,50
500 4X4 MAUNUAL G/ BOX UTILITY	98-04	78-05600	24,30	78-05600	24,30



Vanteet ja renkaat



Talvituotteet



Vinssi



Laukut ja tuulisuojat



Sähköosat



Jousitus ja voimansiirto



Pakoputket ja suutinsarjat



Ohjaus



Rungon osat ja peitteet



Jarrupalat ja rattaat



Moottori



Variaattorin osat



Maatalous-tarvikkeet



Kärryt ja reet



ATV



ATV



ATV



ATV



Vanteet ja renkaat



Talvituotteet



Vinssit



Laukut ja tuulisuojat



Sähköosat



Jousitus ja voimansiirto



Pakoputket ja suutinsarjat



Ohjauk



Rungon osat ja peitteet



Jarrupalat ja rattaat



Moottori



Variaattorin osat



Maatalous-tarvikkeet



Kärryt ja reet

ATV

JARRUPALAT BRONCO JATKUU

BRONCO
ATV COMPONENTS

ARCTIC CAT		Eteen	Hinta	Taakse	Hinta
500 4X4 MAUNUAL G/ BOX UTILITY	05-09	78-05026	26,50	78-05026	26,50
500 4X4 AUTOMATIC TBX	2004	78-05600	24,30	78-05600	24,30
500 4X4 AUTOMATIC TBX	05-06	78-05026	26,50	78-05026	26,50
500 4X4 AUTOMATIC TRV UTILITY	2005	78-05600	24,30	78-05600	24,30
500 4X4 AUTOMATIC TRV MULTI RIDER	05-08	78-05026	26,50	78-05026	26,50
500 XT/TRV	13-14	78-05026	26,50	78-05026	26,50
500i	2002	78-05600	24,30	78-05600	24,30
550 (ALL MODELS)	11-14	78-05026	26,50	78-05026	26,50
650 HI 4X4 AUTO	04-08	78-05600	24,30	78-05600	24,30
650 HI 4X4 AUTO	2010	78-05026	26,50	78-05026	26,50
650 MUDPRO	10-11	78-05026	26,50	78-05026	26,50
650 HI TRV/MUDPRO	09-10	78-05026	26,50	78-05026	26,50
650 HI TRV/TBX PLUS MULTI RIDER	2007	78-05027	26,50	78-05027	26,50
650 HI TRV 4X4 AUTO	2008	78-05027	26,50	78-05027	26,50
650 TBX	2009	78-05027	26,50	78-05027	26,50
650 V2 4X4 AUTO UTILITY	04-06	78-05027	26,50	78-05027	26,50
650 (4X4 AUTO/AUTO LE)	04-08	78-05026	26,50	78-05026	26,50
PARKING BRAKE		78-05600	24,30	----	
650 H1 4X4 AUTO	05-09	78-05026	26,50	78-05026	26,50
PARKING BRAKE		78-05600	24,30	----	
700 (ALL MODELS)	06-14	78-05026	26,50	78-05026	26,50
ARCTIC CAT 1000 (ALL MODELS)	08-14	78-05026	26,50	78-05026	26,50

CAN-AM	VM	Eteen	Hinta	Taakse	Hinta
DS 250	07-14	78-05025	26,50	78-05025	26,50
DS 70 (2X4.4T)	08-14			78-05611	25,50
DS250	07-12	78-05025	26,50	78-05025	26,50
DS450 (ALL)	08-12	78-05268	27,50	AT-05810	
DS650 BAJA L	01-06	78-05611	25,50	78-05611	25,50
DS650 BAJA R	01-06	78-05612	25,50		
DS650 L	00-05	78-05611	25,50	78-05611	25,50
DS650 R	00-05	78-05612	25,50		
DS650 X LEFT	2007	78-05611	25,50	78-05611	25,50
DS650 X RIGHT	2007	78-05612	25,50		
DS90(2 AND 4 STROKE)	08-12	78-05612	25,50	78-05611	25,50
MAVERICK 1000 Left	13-14	78-05266	27,50	78-05267	27,50
MAVERICK 1000 Right	13-14	78-05267	27,50		
OUTLANDER 1000 STD/ XT Left	12-13	78-05266	27,50	78-05267	27,50
OUTLANDER 1000 STD/ XT Right	12-13	78-05267	27,50		
OUTLANDER 330 L	04-05	78-05611	25,50	78-05611	25,50
OUTLANDER 330 R	04-05	78-05612	25,50		
OUTLANDER 400 (ALL) Left	07-14	78-05611	25,50	78-05611	25,50
OUTLANDER 400 (ALL) Right	07-14	78-05612	25,50		
OUTLANDER 400 EFI Left	09-14	78-05611	25,50	78-05611	25,50
OUTLANDER 400 EFI Right	09-14	78-05612	25,50		
OUTLANDER 400 MAX HO/EFI/STD L	07-14	78-05611	25,50	78-05611	25,50
OUTLANDER 400 MAX HO/EFI/STD R	07-14	78-05612	25,50		
OUTLANDER 500 (ALL) Left	07-12	78-05611	25,50	78-05611	25,50
OUTLANDER 500 (ALL) Right	07-12	78-05612	25,50		
OUTLANDER 500 (ALL) Left	13-14	78-05267	27,50	78-05266	27,50
OUTLANDER 500 (ALL) Right	13-14	78-05266	27,50		
OUTLANDER 650 ALL Left	07-12	78-05611	25,50	78-05611	25,50
OUTLANDER 650 ALL Right	07-12	78-05612	25,50		

CAN-AM	VM	Eteen	Hinta	Taakse	Hinta
OUTLANDER 650 ALL Left	13-14	78-05267	27,50	78-05266	
OUTLANDER 650 ALL Right	13-14	78-05266	27,50		
OUTLANDER 800 L (ALL)	2006	78-05611	25,50	78-05611	25,50
OUTLANDER 800 R (ALL)	2006	78-05612	25,50		
OUTLANDER 800 R STD/ XT(P)/DPS Left	12-14	78-05266	27,50	78-05266	
OUTLANDER 800 R STD/ XT(P)/DPS Right	12-14	78-05267	27,50		
OUTLANDER 800 R Xmr/ EFI/MAX/XT/Xxc/TP Left	07-12	78-05611	25,50	78-05611	25,50
OUTLANDER 800 R Xmr/ EFI/MAX/XT/Xxc/TP Right	07-12	78-05612	25,50		
OUTLANDER 800 STD/XT (4x4/EFI) Left	07-08	78-05611	25,50	78-05611	25,50
OUTLANDER 800 STD/XT (4x4/EFI) Right	07-08	78-05612	25,50		
OUTLANDER MAX 800 (ALL) Left	07-12	78-05611	25,50	78-05611	25,50
OUTLANDER MAX 800 (ALL) Right	07-12	78-05612	25,50		
QUEST 500 L	2002	78-05611	25,50	78-05612	25,50
QUEST 500 R	2002	78-05612	25,50		
QUEST 650 (4X4) L	02-04	78-05611	25,50	78-05612	25,50
QUEST 650 (4X4) R	02-04	78-05612	25,50		
QUEST 650 XT L	2002	78-05611	25,50	78-05612	25,50
QUEST 650 XT R	2002	78-05612	25,50		
QUEST MAX /STD/XT L	04-05	78-05611	25,50	78-05612	25,50
QUEST MAX /STD/XT R	04-05	78-05612	25,50		
QUEST MAX 650 L	03-05	78-05611	25,50	78-05612	25,50
QUEST MAX 650 R	03-05	78-05612	25,50		
RALLY 200	2007			78-05611	25,50
RENEGADE 1000 STD/XXC Left	12-14	78-05267	27,50	78-05267	27,50
RENEGADE 1000 STD/XXC Right	12-14	78-05266	27,50	78-05266	27,50
RENEGADE 500 (4x4/EFI) Left	07-12	78-05611	25,50	78-05611	25,50
RENEGADE 500 (4x4/EFI) Right	07-12	78-05612	25,50		
RENEGADE 500 STD LEFT	13-14	78-05267	27,50	78-05267	27,50
RENEGADE 500 STD RIGHT	13-14	78-05266	27,50	78-05266	27,50
RENEGADE 800 ALL Left	12-14	78-05266	27,50	78-05267	27,50
RENEGADE 800 ALL Right	12-14	78-05267	27,50		
RENEGADE 800 ALL Left	07-11	78-05611	25,50	78-05611	25,50
RENEGADE 800 ALL Right	07-11	78-05612	25,50		
TRAXTER MAX 650 L	04-05	78-05611	25,50	78-05612	25,50
TRAXTER MAX 650 R	04-05	78-05612	25,50		
TRAXTER 4X4	2001	78-05611	25,50	78-05611	25,50
TRAXTER 4X4	2001	78-05612	25,50		
TRAXTER AUTOSHIFT L	01-05	78-05612	25,50		
TRAXTER AUTOSHIFT R	01-05	78-05611	25,50	78-05612	25,50
TRAXTER FOOTSHIFT L	2001	78-05611	25,50	78-05612	25,50
TRAXTER MAX L	03-05	78-05611	25,50	78-05612	25,50
TRAXTER MAX L	03-05	78-05612	25,50	78-05612	25,50
TRAXTER MAX R	03-05	78-05612	25,50		
TRAXTER MAX R	03-05	78-05611	25,50	78-05612	25,50
TRAXTER XL (4X4) L	01-04	78-05611	25,50	78-05612	25,50
TRAXTER XL (4X4) R	01-04	78-05612	25,50		
TRAXTER XL R	2004	78-05611	25,50	78-05612	25,50
TRAXTER XL R	2004	78-05612	25,50		
TRAXTER XT (4X4) L	2001	78-05611	25,50	78-05612	25,50
TRAXTER XT (4X4) R	2001	78-05612	25,50		
COMMANDER 800 Left	11-14	78-05562	24,30	78-05561	24,30
COMMANDER 800 Right	11-14	78-05561	24,30		
COMMANDER 1000 Left	11-14	78-05562	24,30	78-05561	24,30

COMMANDEER 1000 Right	11-14	78-05561	24,30		
CANNONDALE	VM	Eteen	Hinta	Taakse	Hinta
FX 400 Left	2001	78-05611	25,50	78-05611	25,50
FX 400 right	2001	78-05612	25,50		
CANNIBAL Left	02-03	78-05611	25,50	78-05611	25,50
CANNIBAL Right	02-03	78-05612	25,50		
SPEED/GLAMIS Left	02-03	78-05611	25,50	78-05611	25,50
SPEED/GLAMIS Right	02-03	78-05612	25,50		
BLAZE 440 Left	02-03	78-05611	25,50	78-05611	25,50
BLAZE 440 Right	02-03	78-05612	25,50		
MOTO 440 Left	02-03	78-05611	25,50	78-05611	25,50
MOTO 440 Right	02-03	78-05612	25,50		
HONDA	VM	Eteen	Hinta	Taakse	Hinta
ATC200X	83-85	78-05404	19,30	78-05404	19,30
ATC200X	86-87	78-05404	19,30	78-05404	19,30
ATC 250 R	1981	78-05453	19,30		
ATC250R	1982	78-05453	19,30	78-05404	19,30
ATC250R	83-84	78-05404	19,30	78-05404	19,30
TRX250EX	01-08	78-05404	19,30		
TRX250X	09-13	78-05404	19,30		
TRX250 RECON ALL	97-14	78-05012	24,30		
TRX300 (2WD)	88-00	78-05012	24,30	78-05411	22,30
TRX300FW FOURTRAX(4WD)	88-00	78-05416	22,30	78-05411	22,30
TRX300EX	93-08	78-05404	19,30	78-05404	19,30
TRX300X	09-11	78-05404	19,30	78-05404	19,30
TRX350/350D	86-89			78-05000	30,50
TRX350 RANCHER 4X4 ALL MODELS	00-06	78-05416	22,30	78-05011	24,30
TRX400EX FOURTRAX/SPORTRAX	99-08	78-05404	19,30	78-05404	19,30
TRX400X	09-13	78-05404	19,30	78-05404	19,30
"TRX400 FW FOURTRAX FOREMAN "	95-01/03	78-05416	22,30	78-05011	24,30
TRX400FM FORTAX FOREMAN	2002	78-05416	22,30	78-05011	24,30
TRX400FA/FGA FORTAX RANCHER/GPSCAPE	04-07	78-05416	22,30	78-05011	24,30
TRX420 TM7/8/9 FORTAX RANCHER	07-14	78-05404	19,30	78-05011	24,30
TRX420 TE FOURTRAX RANCHER ES	07-11	78-05404	19,30	78-05011	24,30
TRX420 FA/FPA FORTAX RANCHER AT	09-12	78-05404	19,30	78-05401	30,50
TRX420 FPE FOURTRAX RANCHER ES/EP	09-14	78-05404	19,30	78-05011	24,30
TRX420 FE/FM FORTAX RANCHER 4X4/ES	07-14	78-05404	19,30	78-05011	24,30
TRX420 FPM FOURTRAX RANCHER 4X4 PS	09-14	78-05404	19,30	78-05011	24,30
TRX450ES FOURTRAX FOREMAN	98-01	78-05416	22,30	78-05011	24,30
"TRX450FE FOURTRAX FOURMAN"	02-04	78-05416	22,30	78-05011	24,30
"TRX450FM FOURTRAX FOURMAN"	02-04	78-05416	22,30	78-05011	24,30
"TRX450S FOURTRAX FOURMAN"	98-01	78-05416	22,30	78-05011	24,30
TRX450R/ER	04-11	78-05286	27,50	78-05401	30,50
TRX500 FOREMAN ALL	01-04	78-05416	22,30	78-05000	30,50
TRX500 FOREMAN ALL	05-11	78-05403	27,50	78-05000	30,50
TRX500 FOREMAN ALL	12-13	78-05404	19,30	78-05000	30,50
TRX650FA RINCON	03-05	78-05416	22,30	78-05401	30,50
TRX650FGA RINCON/GPSCAPE	04-05	78-05416	22,30	78-05401	30,50
TRX680FGA RINCON/GPSCAPE	06-09	78-05403	27,50	78-05401	30,50
TRX680FA RINCON	06-12	78-05403	27,50	78-05401	30,50
TRX700 XX	08-11	78-05286	27,50		
MUV 700 BIG RED	09-13	78-05416	22,30		

HYOSUNG ATV	VM	Eteen	Hinta	Taakse	Hinta
TE 450 S	07-12	78-05453	19,30	78-05453	19,30
JOHN DEERE	VM	Eteen	Hinta	Taakse	Hinta
TRAILBUCK 500/650 UTILITY R	04-08	78-05612	25,50		78-05612
TRAILBUCK 500/650 UTILITY L	04-08	78-05611	25,50		
BUCK 500/650 R	04-08	78-05612	25,50		78-05612
BUCK 500/650 L	04-08	78-05611	25,50		
KAWASAKI	VM	Eteen	Hinta	Taakse	Hinta
KXT250 B2 TECATE	1987			78-05404	19,30
KSF250 A1-A13 MOJAVE	87-04			78-05404	19,30
KXF250 A1/2 TECATE	87-88			78-05404	19,30
KEF300 A1-5 LAKOTA	95-00			78-05404	19,30
KEF300 LAKOTA SPORT	01-03			78-05404	19,30
KLF300 BAYOU 4X4 LEFT	89-05	78-05561(L)	24,30		
KLF300 BAYOU 4X4 RIGHT	89-05	78-05562(R)	24,30		
KVF300 A1(4X4)PRAIRIE	99-02	78-05453	19,30		
KVF300 B1(2X4)PRAIRIE	99-02	78-05453	19,30		
KVF360 B1/B2/B3/B6F PRAIRIE	03-09	78-05453	19,30		
KVF360A PRAIRIE 4X4	03-12	78-05453	19,30		
KVF360B PRAIRIE	03-09	78-05453	19,30		
KVF360C PRAIRIE 4X4 HARDWOODS GREEN	03-11	78-05453	19,30		
KLF400 BAYOU 4X4	93-99	78-05561(L)	24,30		
KLF400 BAYOU 4X4	93-99	78-05562(R)	24,30		
"KVF400 A1/A2/B1 PRAIRIE "	97-98	78-05453	19,30		
KVF400 B2 (2X4)	99-02	AT-05543	19,30		
KVF400 A3 (4X4)	99-02	78-05453	19,30		
KFX400/KFS400	03-06	78-05404	19,30		
KFX450R Left	08-14	78-05016(L)	27,50	78-05404	19,30
KFX450R Right	08-14	78-05265(R)	27,50		
KVF650 PRAIRIE (all) left	02-03	78-05016(L)	27,50		
KVF650 PRAIRIE (all) left	02-03	78-05265(R)	27,50		
KVF650 BRUTE FORCE 4X4 Left	05-11	78-05016(L)	27,50		
KVF650 BRUTE FORCE 4X4 Right	05-11	78-05265(R)	27,50		
KVF650 BRUTE FORCE 4X4i	06-12	78-05561(L)	24,30		
KVF 700 PRAIRIE 4X4/HARDWOODS GREEN HD	04-06	78-05562(R)	24,30		
KSV 700 (KFX 700 V FORCE)	04-08	78-05016(L)	27,50		
KSV 700 (KFX 700 V FORCE)	04-08	78-05265(R)	27,50		
KVF/KSV 700 PRAIRIE 4X4	04-09	78-05016(L)	27,50		
KVF/KSV 700 PRAIRIE 4X4	04-09	78-05265(R)	27,50		
KVF750 BRUTE FORCE Right	05-14	78-05561(R)	24,30		
KVF750 BRUTE FORCE Left	05-14	78-05562(L)	24,30		
KAF450 B1 MULE 1000	Kaikki			78-05156	27,50
KAF540 C1 MULE 2010	Kaikki			78-05156	27,50
KAF540 D1 MULE 2020	Kaikki			78-05156	27,50
KAF540 E1 MULE 2030	Kaikki			78-05156	27,50
KAF 620 E1-E5 MULE 3010	Kaikki	78-05156	27,50		
KAF 620 MULE 3000	Kaikki	78-05156	27,50		
KAF 620 MULE 3020	Kaikki	78-05156	27,50		
"KAF620 A1-A6 MULE 2510 "	Kaikki			78-05156	27,50
"KAF620 B1-B6 MULE 2520"	Kaikki			78-05156	27,50
"KAF620 C1-/C6 MULE 2500"	Kaikki			78-05156	27,50
KAF620 E/F1 E/F2 E/F3 E4/E5MULE	Kaikki	78-05156	27,50		





JARRUPALAT BRONCO JATKUU



KAWASAKI	VM	Eteen	Hinta	Taakse	Hinta
KAF620 H1/H2/H3 MULE	03-05			78-05156	27,50
KAF620 K1/K6F/K7F MULE	05-07			78-05156	27,50
KAF620 J1 MULE	2005			78-05156	27,50
KAF620 M/R/S MULE 4000	09-10			78-05156	27,50
KAF620 M/R/S MULE 4010	09-12			78-05156	27,50
KVF 650 F9F BRUTE FORCE	2008	78-05561 (R)	24,30		
KVF 650 F9F BRUTE FORCE	2008	78-05562 (L)	24,30		
KRF750 TERYX	08-13	78-05561 (R)	24,30		
KRF750 TERYX	08-13	78-05562 (L)	24,30		
KAF 950 MULE DIESEL	03-05			78-05156	27,50
KAF 950 MULE DIESEL 3010 DIESEL	2008			78-05156	27,50
KAF 950 MULE DIESEL 4010 DIESEL	09-12			78-05156	27,50

KYMCO	VM	Eteen	Hinta	Taakse	Hinta
KXR250 Mongoose	04-09	78-05025	26,50		
MXU250	04-10	78-05025	26,50		
Urban Quad 250	06-08	78-05025	26,50		
300 Mongoose	06-14	78-05025	26,50		
Maxxer 300	06-08	78-05025	26,50		
MXU300 (S/D)	05-14	78-05025	26,50	78-05025	26,50
MXU 375 4X4 IRS	08-14	78-05026	26,50	78-05026	26,50
MAXXER 450I IRS	11-14	78-05026	26,50	78-05026	26,50
MXU 500 4X4 ALL	06-10	78-05025	26,50	78-05025	26,50
MXU 500 4X4 IRS	06-10	78-05025	26,50	78-05025	26,50
MXU 500 4X4 IRS PARKING BRAKE	10-12	78-05025	26,50		
MXU 500i IRS 4X4	12-13	78-05074	32,00	78-05074	32,00
UXV 500 4X4 SIDE BY SIDE (ALL)	08-14	78-05025	26,50	78-05025	26,50
MXU 550i IRS 4X4	12-13	78-05074	32,00	78-05074	32,00
MXU 700i IRS 4X4	13-14	78-05074	32,00	78-05074	32,00
UVX 700i	2014-	78-05025	26,50		

POLARIS	VM	Eteen	Hinta	Taakse	Hinta
BIG BOSS 4X6 250	89-92	78-05654	25,50	78-05655	26,50
BIG BOSS 6X6 250	1991	78-05654	25,50	78-05655	26,50
BIG BOSS 6X6 250 Mid Axle Brake	1991	78-05654	25,50		
BIG BOSS 6X6 250	92-93	78-05654	25,50	78-05655	26,50
BIG BOSS 6X6 250 Mid Axle Brake	92-93	78-05654	25,50		
TRAIL BLAZER 250	99-04	78-05654	25,50	78-05657	24,30
TRAIL BLAZER 250	90-98	78-05654	25,50	78-05655	26,50
TRAIL BLAZER 250	05-06	78-05654	25,50		
TRAIL BLAZER 250 FREEDOM	01-04	78-05654	25,50	78-05657	24,30
TRAIL BOSS 250	88-99	78-05654	25,50	78-05655	26,50
TRAIL BOSS 4X4	1987	78-05453	19,30	78-05655	26,50
TRAIL BOSS 2X4/4X4 250	88-92	78-05654	25,50	78-05655	26,50
XPLORER 250 4X4	2000	78-05654	25,50	78-05657	24,30
HAWKEYE 300 2X4/4X4	2006	78-05026	26,50	78-05026	26,50
HAWKEYE 300 2X4	07-09	78-05654	25,50	78-05654	25,50
HAWKEYE 400	13-14	78-05654	25,50	78-05038	25,50
SPORTSMAN 300 4X4	08-10	78-05654	25,50	78-05654	25,50
XPLORER 300 4X4	96-00	78-05654	25,50	78-05655	26,50
300 / 400 XPRESS L	96-97	78-05654	25,50	78-05655	26,50
300 XPRESS 2 X 4	96-97	78-05654	25,50	78-05655	26,50
MAGNUM 325 2X4/4X4	2000	78-05654	25,50	78-05657	24,30
MAGNUM 325 2X4/4X4 MOSE	2001	78-05654	25,50	78-05657	24,30
MAGNUM 325 4X4 HDS	2002	78-05654	25,50	78-05015	30,00
MAGNUM 325 2X4	2002	78-05654	25,50	78-05015	30,00
MAGNUM 325 4X4 (A02CD32AA/AB/AC)	2002	78-05654	25,50	78-05015	30,00
TRAILBOSS 325	2000	78-05654	25,50	78-05657	24,30
TRAILBOSS 325	01-02	78-05654	25,50	78-05657	24,30

POLARIS	VM	Eteen	Hinta	Taakse	Hinta
XPEDITION 325	2000	78-05654	25,50	78-05657	24,30
XPEDITION 325	2002	78-05654	25,50	78-05015	
ATP330 (4X4)	04-05	78-05654	25,50	78-05654	25,50
MAGNUM 330 2X4/4X4 HDS	03-06	78-05654	25,50	78-05015	30,00
TRAILBOSS 330	03-04	78-05654	25,50	78-05657	24,30
TRAILBOSS 330	05-12	78-05654	25,50	78-05015	30,00
TRAILBLAZER 330	08-13	78-05654	25,50	78-05015	30,00
SPORTSMAN 335 4X4	99-00	78-05654	25,50	78-05657	24,30
SPORTSMAN 335 (WORKER)	99-00	78-05654	25,50	78-05657	24,30
350 L 2X4 / 4X4	90-93	78-05654	25,50	78-05655	26,50
BIG BOSS 400L 6X6	94-97	78-05654	25,50	78-05655	26,50
BIG BOSS 400L 6X6 MID AXLE BRAKE	94-97	78-05654	25,50		
SCRAMBLER 400 2X4/4X4	95-97	78-05654	25,50	78-05655	26,50
SCRAMBLER 400 2X4/4X4	98-02	78-05654	25,50	78-05657	24,30
400 SPORT L	94-98	78-05654	25,50	78-05655	26,50
400 SPORT	99-00	78-05654	25,50	78-05657	24,30
SPORTSMAN 4X4 400L	94-97	78-05654	25,50	78-05655	26,50
SPORTSMAN 400	01-02	78-05654	25,50	78-05657	24,30
SPORTSMAN 400	03-04	78-05654	25,50	78-05015	30,00
SPORTSMAN 400 HO	08-10	78-05654	25,50	78-05654	25,50
SPORTSMAN 400 HO	11-14	78-05654	25,50	78-05038	25,50
400 TRAIL BLAZER	2003	78-05654	25,50	78-05657	24,30
XPLORER 400L 4X4	95-98	78-05654	25,50	78-05655	26,50
XPLORER 400L 4X4	99-02	78-05654	25,50	78-05657	24,30
MAGNUM 425 2X4/4X4	95-98	78-05654	25,50	78-05655	26,50
MAGNUM 425 6X6	96-97	78-05654	25,50	78-05655	26,50
450 OUTLAW MXR	09-10			78-05654	25,50
SPORTSMAN 450	06-07	78-05654	25,50	78-05015	30,00
DIESEL 455 4X4	99-01	78-05654	25,50	78-05657	24,30
500 ATP HO (4X4)	04-05	78-05654	25,50	78-05654	25,50
500 ATV PRO 4X4 PPS	2002	78-05654	25,50	78-05015	30,00
BIG BOSS 6X6 500	98-99	78-05654	25,50	78-05655	26,50
BIG BOSS 6X6 500 MID AXLE BRAKE	98-99	78-05654	25,50		
MAGNUM 500	99-01	78-05654	25,50	78-05657	24,30
MAGNUM 500 2X4/4X4 HDS	02-03	78-05654	25,50	78-05015	30,00
OUTLAW 500	06-07	78-05654	25,50	78-05654	25,50
PREDATOR 500/TLD 500	03-07	78-05654	25,50	78-05654	25,50
SCRAMBLER 500 2X4	01-02	78-05654	25,50	78-05657	24,30
SCRAMBLER 500 2X4	07-08	78-05654	25,50	78-05015	30,00
SCRAMBLER 500 4X4	1997	78-05654	25,50	78-05655	26,50
SCRAMBLER 500 4X4	98-04	78-05654	25,50	78-05657	24,30
SCRAMBLER 500 4X4	05-13	78-05654	25,50	78-05015	30,00
SPORTSMAN 500	96-97	78-05654	25,50	78-05655	26,50
SPORTSMAN 500/WORKER 4X4 EBS	98-02	78-05654	25,50	78-05657	24,30
SPORTSMAN 500 HO/EFI/X2	03-08	78-05654	25,50	78-05015	30,00
SPORTSMAN 500 6X6	00-08	78-05654	25,50		
SPORTSMAN 500 X2 EFI	07-09	78-05654	25,50	78-05654	25,50
SPORTSMAN 500 FOREST	2012	78-05654	25,50	78-05015	30,00
SPORTSMAN 500 TOURING HO	08-11	78-05654	25,50	78-05654	25,50
SPORTSMAN 500 TOURING HO	11-13	78-05654	25,50	78-05019	
SPORTSMAN 500 EFI QUAD HO	08-11	78-05654	25,50	78-05015	30,00
LSV 4X4	10-11			78-05057	30,50
RANGER 2X4 500 CARB	08-09			78-05057	30,50
RANGER 500 2X4/4X4	05-10			78-05057	30,50
500 XP SPORTSMAN	2009	78-05038	25,50	78-05038	25,50
XPLORER 500	1997	78-05654	25,50	78-05655	26,50
525 S OUTLAW/IRS	08-10	78-05419	28,50	78-05015	30,00
525 OUTLAW IRS	08-11	78-05419	28,50	78-05015	30,00
550 SPORTSMAN	11-13	78-05038	25,50	78-05038	25,50
550 SPORTSMAN XP EPS	09-10	78-05038	25,50	78-05038	25,50

POLARIS	VM	Eteen	Hinta	Taakse	Hinta
550 SPORTSMAN TOURING EPS	10-13	78-05038	25,50	78-05038	25,50
SPORTSMAN 600	03-05	78-05654	25,50	78-05015	30,00
RANGER 4X4 700 EFI/XP ALL OPTIONS	07-09			78-05057	30,50
RANGER XP 4X4 700	05-06			78-05057	30,50
RANGER 700 6X6	05-09			78-05057	30,50
SPORTSMAN 700 EFI	02-07	78-05654	25,50	78-05015	30,00
SPORTSMAN MV 700	05-06	78-05654	25,50	78-05015	30,00
SPORTSMAN 700 X2	2008	78-05654	25,50	78-05015	30,00
SPORTSMAN 800 EFI	05-09	78-05654	25,50	78-05015	30,00
SPORTSMAN 800 EFI	10-12	78-05654	25,50	78-05038	25,50
SPORTSMAN 800 EFI X2	07-09	78-05654	25,50	78-05015	30,00
SPORTSMAN 800 EFI Intl./HO	07-11	78-05654	25,50	78-05015	30,00
800 SPORTSMAN FOREST / TRACTOR	2012	78-05038	25,50	78-05038	25,50
SPORTSMAN 800 TOURING/EFI	08-09	78-05654	25,50	78-05015	30,00
SPORTSMAN 800 EFI 6X6	09-12	78-05654	25,50	78-05015	30,00
RANGER 4X4 800 EFI ALL OPTIONS	10-11			78-05057	30,50
RANGER XP 800	2012			78-05057	30,50
RANGER CREW 800	2012			78-05057	30,50
RANGER 6X6 800/CREW 800	10-12			78-05057	30,50
RANGER 900 DIESEL/ CREW 900	11-14			78-05057	30,50
RANGER EV 4X4/INTL	10-11			78-05057	30,50
RANGER EV MIDSIZED/ INTL	13-14			78-05057	30,50
850 SPORTSMAN TOURING EPS	10-13	78-05038	25,50	78-05038	25,50
SPORTSMAN HO SC-RAMBLER	2013	78-05038	25,50	78-05038	25,50
850 XP SPORTSMAN/EPS SPORTSMAN	09-12	78-05038	25,50	78-05038	25,50
PPS/PTV 4X4/SERIES 10		78-05651	18,30	78-05015	30,00
PPS/PTV 6X6/SERIES 10		78-05651	18,30		
PPS/PTV 2X4/SERIES 10		78-05019	27,50	78-05019	27,50
PPS/PTV 4X6/SERIES 10		78-05019	27,50	78-05019	27,50
1500 PPS/UTV 2X4 SERIES 11		78-05019	27,50	78-05019	27,50
PPS LUH 6X6	2002	78-05019	27,50	78-05019	27,50
PPS/SERIES 11 2X4/4X4		78-05019	27,50	78-05019	27,50
PPS/SERIES 11 6X6		78-05019	27,50	78-05019	27,50
RANGER SERIES 10/11		78-05019	27,50	78-05019	27,50
RANGER 2X4/4X4	04-05	78-05019	27,50	78-05019	27,50
RANGER 6X6	04-05	78-05019	27,50	78-05019	27,50
RANGER TM/XP	04-06	78-05019	27,50	78-05019	27,50
RANGER 500 SERIES 10 6X6		78-05019	27,50	78-05019	27,50
RANGER 6X6 (NO MID AXLE BRAKE) 4 REAR DISCS	1999	78-05651	18,30		
400 RANGER HO	10-13	78-05019	27,50	78-05019	27,50
RANGER 500 2X4/4X4	06-07	78-05019	27,50	78-05019	27,50
RANGER 500 4X4 EFI	06-07	78-05019	27,50	78-05019	27,50
500 RANGER (EFI) 4X4	08-10	78-05039	25,50	78-05019	27,50
500 RANGER (EFI) 4X4	11-13	78-05019	27,50	78-05019	27,50
500 RANGER (CARB) 2X4	08-09	78-05039	25,50	78-05019	27,50
500 RANGER CREW	11-12	78-05039	25,50	78-05019	27,50
550 SPORTSMAN X2	2010	78-05038	25,50	78-05038	25,50
RZR 570 (ALL MODELS)	12-13	78-05419	28,50	78-05654	25,50
RANGER 700 6X6 EFI	06-09	78-05019	27,50	78-05019	27,50
RANGER XP 700 4X4	2006	78-05019	27,50	78-05019	27,50
700 RANGER 4X4 EFI/LE	2007	78-05019	27,50	78-05019	27,50
RANGER 6X6 EFI 700	2008	78-05039	25,50	78-05019	27,50
700 RANGER 4X4 EFI/LE	2009	78-05039	25,50	78-05019	27,50
700 RANGER CREW (EFI)	2009	78-05039	25,50	78-05019	27,50
700 RANGER	2008	78-05039	25,50	78-05019	27,50
700 RANGER CREW EFI 4X4	2009	78-05039	25,50	78-05039	25,50

POLARIS	VM	Eteen	Hinta	Taakse	Hinta
RANGER XP 700 4X4	2008	78-05039	25,50	78-05019	27,50
RANGER 800 RZR	08-13	78-05419	28,50	78-05654	25,50
RANGER 800 RZR-4	10-13	78-05039	25,50	78-05019	27,50
800 RANGER EV (ELECTRIC)	10-13	78-05039	25,50	78-05019	27,50
RANGER 800	10-13	78-05039	25,50	78-05019	27,50
RANGER 800 MID SIZE	2013	78-05019	27,50	78-05019	27,50
800 RANGER XP/HD	10-11	78-05039	25,50	78-05019	27,50
800 RANGER 6X6	10-13	78-05039	25,50	78-05039	25,50
RANGER 900 D CREW CAB DIESEL	2013	78-05039	25,50	78-05039	25,50
900 D RANGER 4X4 DIESEL	11-13	78-05039	25,50	78-05019	27,50
900 RANGER RXR XP / EFI / EPS	11-13	78-05039	25,50	78-05019	27,50
RANGER 900 RZR XP 4	2013	78-05039	25,50	78-05039	25,50
SUZUKI	VM	Eteen	Hinta	Taakse	Hinta
LT-F 4WD V/W QUAD-RUNNER 4WD 250	97-98	78-05453	19,30		
LT-F 250 FK2/FK3 OZARK	02-13	78-05453	19,30	78-05406	25,50
LT-Z 250 K4 QUADSPORT	04-11			78-05406	25,50
LT-F300F KING QUAD Left	2002	78-05561(L)	24,30		
LT-F300F KING QUAD Right	2002	78-05562(R)	24,30		
LTA/-F 400 KING QUAD (ALL) left	08-11	78-05032(L)	17,30		
LTA/-F 400 KING QUAD (ALL) right	08-11	"			
78-05033(R)"	17,30				
LT-F 400F K2,K3,K4, K5 EIGER 4WD	02-07	78-05453	19,30		
LT-A 400 K2, K3,K4,K5,K6,FCK5,FCK6 EIGER 2WD	02-07	78-05453	19,30		
LT-A 400 FK8 FING QUAD AUTO 4WD L	08-09	78-05032(L)	17,30		
LT-A 400 FK8 FING QUAD AUTO 4WD R		"			
78-05033(R)"	17,30				
LT-F 400F K8 MANUAL 2WD	2002	78-05453	19,30		
LT-F 400F K2,K3,K4,K5,K6,K7	03-08	78-05453	19,30		
LT-F 400 FL1/FCL KING QUAD 400 Fsi L	2011	78-05032(L)	17,30		
LT-F 400 FL1/FCL KING QUAD 400 Fsi R		"			
78-05033(R)"	17,30				
LT-Z400 QUADSPORT	03-13	78-05404	19,30		
LT-R450 (ALL) L	06-11	78-05561(L)	24,30		
LT-R450 (ALL) R	06-11	78-05562(R)	24,30		
LT-A 450 KING QUAD (ALL) L	07-10	78-05032(L)	17,30		
LT-A 451 KING QUAD (ALL) R	07-10	"			
78-05033(R)"	17,30				
LT500 RH/RJ/RK/RL	87-90	AT-05504			
LT-F500F QUADRUNNER L	98-02	78-05561(L)	24,30		
LT-F500F QUADRUNNER R	98-02	78-05562(R)	24,30		
LT-F500F QUADRUNNER VINSON QUADRUNNER	03-07	78-05453	19,30		
LT-F500F QUADMAS-TER L	00-01	78-05561(L)	24,30		
LT-F500F QUADMAS-TER R	00-01	78-05562(R)	24,30		
LT-A500 FK2 VINSON 4WD	02-07	78-05453	19,30	78-05612	25,50
LT-A500 FK3,KF4,FK5,FCK5,FCK6,FCK7,FCK8	03-07	78-05453	19,30		
VINSON 4WD	03-07	78-05453	19,30		
LT-A 500 KING QUAD (ALL)	09-11	78-05032(L)	17,30		



Vanteet ja renkaat



Talvituuotteet



Vinsit



Laukut ja tuulisuojat



Sähköosat



Jousitus ja voimansiirto



Pakoputket ja suutinsarjat



Ohjaus



Rungon osat ja peitteet



Jarrupalat ja rattaat



Moottori



Variaattorin osat



Maatalous-tarvikkeet



Kärryt ja reet

ATV





JARRUPALAT BRONCO JATKUU



Vanteet ja renkaat



Talvituotteet



Vinssit



Laukut ja tuulisuojat



Sähköosat



Jousitus ja voimansiirto



Pakoputket ja suutinsarjat



Ohjaukset



Rungon osat ja peitteet



Jarrupalat ja rattaat



Moottori



Variaattorin osat



Maatalous-tarvikkeet



Kärryt ja reet

SUZUKI	VM	Eteen	Hinta	Taakse	Hinta
78-05033(R)"	17,30	"			
LT-A 700 KING QUAD	05-11	78-05032(L)	17,30		
78-05033(R)"	17,30	"			
LT-V 700 TWIN PEAKS	04-05	78-05016(L)	27,50		
78-05265(R)"	27,50	"			
LT-A 750 KING QUAD (ALL)	08-11	78-05032(L)	17,30		
78-05033(R)"	17,30	"			
SYM ATV	VM	Eteen	Hinta	Taakse	Hinta
QUADLANDER 300	07-10	78-05025	26,50	78-05025	26,50
QUADLANDER 600	08-10	78-05453	19,30	78-05025	19,30

TGB	VM	Eteen	Hinta	Taakse	Hinta
OUTBACK 425 ALL	07-09	78-05025	26,50	78-05025	26,50

YAMAHA	VM	Eteen	Hinta	Taakse	Hinta
YFM125 RAPTOR	11-13	78-05453	19,30	78-05404	19,30
YFS200 BLASTER	03-06	78-05453	19,30	78-05404	19,30
YFM 250 BEARTRACKER	00-04	78-05453	19,30		
YFM250 BRUIN	05-06	78-05453	19,30	78-05408	22,30
YFB250 D/E/F 4X4	01-04	78-05453	19,30		
YFM BIG BEAR	07-09	78-05453	19,30	78-05408	22,30
YFM 250 RAPTOR	08-13	78-05028(L)	26,50	78-05404	19,30

YFM 250 RSPX/RSEY	08-09-11	78-05028(L)	26,50	78-05404	19,30
-------------------	----------	--------------------	-------	-----------------	-------

YFM350 WOLVERINE	95-05	78-05453	19,30	78-05404	19,30
YFM350 WOLVERINE (2WD)	2006	78-05453	19,30	78-05408	22,30
YFM 350 GRIZZLY AYTO IRS 4X4	07-11	78-05453	19,30		

YFM 350 GRIZZLY AUTO 4X4/ 2X4	07-11	78-05453	19,30	78-05408	22,30
-------------------------------	-------	-----------------	-------	-----------------	-------

YFM350 XT	1987			78-05404	19,30
YFM 350 BIG BEAR	1999	78-05453	19,30		
YFM350 WARRIOR XU	1988			78-05404	19,30
YFM350 WARRIOR XW	1989	78-05453	19,30	78-05404	19,30
YFM350 WARRIOR	90-04	78-05453	19,30	78-05404	19,30
YFZ350 BANSHEE	87-89			78-05404	19,30
YFZ350 BANSHEE	90-06	78-05453	19,30	78-05404	19,30

YFM350 UL/ULC	1999	78-05453	19,30		
YFM350 BRUIN 2X4,4X4	04-06	78-05453	19,30	78-05408	22,30
YFM350 RAPTOR	04-13	78-05404	19,30	78-05404	19,30
YFM350 WOLVERINE (2WD)	06-09	78-05453	19,30	78-05408	22,30

YFP350 U TERRAPRO	1988				
YFUITW PRO HAULER	1989				
YFM 400 KODIAK	1999	78-05453	19,30		
YFM 400 BIG BEAR 2X4	03-04	78-05453	19,30		
YFM400FAR KODIAK AUTO	2003	78-05453	19,30		

YFM400 FAM/FAN/FAP KODIAK 4WD	00-02	78-05453	19,30	78-05611	25,50
YFM400FAH KODIAK 4WD	00-01	78-05453	19,30	78-05611	25,50

YFM 400 BIG BEAR 2WD	00-02	78-05453	19,30		
YFM 400 S BIG BEAR 2WD	2004	78-05453	19,30		

YAMAHA	VM	Eteen	Hinta	Taakse	Hinta
YFM 400 BIG BEAR 4X4	05-06	78-05453	19,30	78-05408	22,30
YFM400 AR/AS KODIAK 2X4	03-04	78-05453	19,30	78-05408	22,30
YFM400 FAS KODIAK 4X4	2004	78-05453	19,30	78-05408	22,30
YFM400 FAT/FAHT/FAV KODIAK 4X4	05-06	78-05453	19,30	78-05611	25,50
YFM400 FGV GRIZZLY 4X4	07-08	78-05453	19,30	78-05611	25,50
YFM400 FS/FT/FV BIG BEAR 4WD	04-06	78-05453	19,30	78-05611	25,50
YFM 400 BIG BEAR HUNTER IRS	07-12	78-05453	19,30		
YFM400 AR/AS KODIAK 2X4,4X4	03-04	78-05453	19,30	78-05408	22,30
YFM400A KODIAK 2WD	00-01	78-05453	19,30	78-05611	25,50
YFM400FHA KODIAK 4WD	2002	78-05453	19,30	78-05611	25,50
YFM400FWAH KODIAK 4WD	2000	78-05453	19,30	78-05611	25,50
YXR450 RHINO 4X4	06-09	78-05561(L)	24,30	78-05562(R)	24,30
YFZ450	04-05	78-05561(L)	24,30	78-05404	19,30
		78-05562(R)	24,30	78-05404	19,30
YFZ450	06-11	78-05561(L)	24,30		
SEW/SPX/RV/RZ/RA/RB BILL BALANCE ED		78-05562(R)	24,30		
YFZ450 BB/DB	12-13	78-05404	19,30		
YFM450FAR/FAS KODIAK	03-04	78-05453	19,30	78-05611	25,50
YFM450FAT/FAHT/FAV KODIAK (AUTO)	05-06	78-05453	19,30	78-05611	25,50
YFM450FXV WOLVERINE	06-10	78-05453	19,30	78-05611	25,50
YFM450 GRIZZLY (ALL)	07-12	78-05453	19,30	78-05611	25,50
YFM450 GRIZZLY	2013	78-05453	19,30		
YFM 550 GRIZZLY 4X4 (ALL)	09-13	78-05028(L)	26,50	78-05030(L)	27,50
		"			
78-05027 (R)"	26,50	"			
78-05029 (R)"	27,50				
YFM600 GRIZZLY	98-01	78-05404	19,30		
YFM660 RAPTOR	01-05	78-05404	19,30	78-05404	19,30
YFM660FH HUNTER EDITION	02-08	78-05404	19,30		
YXR660 FAR/FAS RHINO 4X4 AUTO SIDE x SIDE	04-07	78-05561(L)	24,30	78-05562(R)	24,30
YFM 700 RDW RAPTOR	2013	78-05561(L)	24,30	78-05562(R)	24,30
YFM 700 RAPTOR 4X4	06-12	78-05561(L)	24,30	78-05562(R)	24,30
YFM 700 GRIZZLY 4X4 (ALL)	07-13	78-05028(L)	26,50	78-05030(L)	27,50
		"			
78-05027 (R)"	26,50	"			
78-05029 (R)"	27,50				
YXR RHINO 700	08-09/11-12	78-05561(L)	24,30	78-05561(L)	24,30
		78-05562(R)	24,30	78-05562(R)	24,30

ATV

JARRULEVYT BRONCO



Malli	Vuosim.	Eteen Tuotenro.	Hinta	Taakse Tuotenro.	Hinta
ARTIC CAT					
250 2x4	1999-09	78-05980	59,90	78-05980	59,90
250 4x4	2001-08	78-05980	59,90	78-05980	59,90
300 4x4 /UTILITY	1998-05	78-05980	59,90	78-05980	59,90
350 ATV	2012	78-05980	59,90		
366 Auto	2008-09	78-05980	59,90	78-05980	59,90
366 SE	2010	78-05980	59,90	78-05980	59,90
Artic Cat 375 (2x4/4x4 Auto)	2002	78-05980	59,90	78-05980	59,90
Artic Cat 400 2x4/4x4 Auto/Manual UTILITY	1998-08	78-05980	59,90	78-05980	59,90
400 FIS (Manual)	2005-07	78-05980	59,90	78-05980	59,90
400 4x4 FIS (Auto)	2005-08	78-05980	59,90	78-05980	59,90
400 TRV/TRV H1	2009-10	78-05980	59,90	78-05980	59,90
400 TRV	2013	78-05750	59,90	78-05750	59,90
400 ATV CR	2013	78-05750	59,90	78-05750	59,90
425i /SE	2012	78-05980	59,90	78-05980	59,90
450 H1 EFI	2010	78-05980	59,90	78-05980	59,90
450i ALL	2011-12	78-05980	59,90	78-05980	59,90
450 TRV	2011-12	78-05980	59,90	78-05980	59,90
XC450i	2011-12	78-05980	59,90	78-05980	59,90
450i XC	2013	78-05750	59,90	78-05750	59,90
Bear Cat 454 2x4/4x4	1996-98	78-05980	59,90	78-05980	59,90
500 (4x4/2x4 Auto/ MAN) UTILITYAll Models	1998-09	78-05980	59,90	78-05980	59,90
500 TRV/TBX (Auto)	2005-06	78-05980	59,90	78-05980	59,90
500 ATV /XT	2013	78-05750	59,90	78-05750	59,90
500 TRV	2013	78-05750	59,90	78-05750	59,90
550 ALL	2009-12	78-05980	59,90	78-05980	59,90
550 ALL	2013	78-05750	59,90	78-05750	59,90
650 H1 ALL	2004-10	78-05980	59,90	78-05980	59,90
650 Mudpro	2010-11	78-05980	59,90	78-05980	59,90
650 V-Twin Auto FIS	2006	78-05980	59,90	78-05980	59,90
650 V-Twin 4x4 FIS	2004-06	78-05980	59,90	78-05980	59,90
700 ALL	2006-12	78-05980	59,90	78-05980	59,90
700 ALL	2013	78-05750	59,90	78-05750	59,90
1000 ALL	2008-10	78-05980	59,90	78-05980	59,90
1000 TRV CRUISER	2011	78-05980	59,90	78-05980	59,90
1000 XT	2013	78-05750	59,90	78-05750	59,90
BOMBARDIER / CAN AM					
Outlander 330 HO	2004-05	78-05981	59,90	78-05985	59,90
Outlander 400 ALL	2003-13	78-05981	59,90	78-05985	59,90
Outlander 500 ALL	2007-12	78-05981	59,90	78-05985	59,90
Outlander 650 ALL	2006-12	78-05981	59,90	78-05985	59,90
Outlander 800 ALL	2006-10	78-05981	59,90	78-05985	59,90
HONDA					
ATC250R	1985-86	78-05757	59,90		
TRX250R	1988-89	78-05757	59,90		
TRX250X	1987-92	78-05757	59,90		

Malli	Vuosim.	Eteen Tuotenro.	Hinta	Taakse Tuotenro.	Hinta
HONDA					
TRX250EX	2001-08	78-05757	59,90		
TRX250X	2009-13	78-05757	59,90		
TRX300EX	1993-08	78-05757	59,90		
TRX300X	2009	78-05757	59,90		
TRX400EX FOURT- RAX	1999-08	78-05757	59,90		
TRX400X	2009-12	78-05757	59,90		
TRX420 ALL (EXCEPT FA/FPA)	2007-12	78-05962	59,90		
TRX420 FA/FPA	2009-12	78-05962	59,90	78-05747	110,00
TRX450R	2004-11	78-05757	59,90		
TRX500 (ALL)	2005-11	78-05748	59,90		
TRX650 FA RINCON	2003-05			78-05747	110,00
TRX650 FGA FOURTRAX RINCON/ GPSCAPE	2004-05			78-05747	110,00
TRX680 FGA6 RIN- CON/GPSCAPE	2006-09	78-05748	59,90	78-05747	110,00
TRX680 FA RINCON	2006-12	78-05748	59,90	78-05747	110,00
TRX700XX	2008-11	78-05757	59,90		
KAWASAKI					
KVF360 Prairie/Hard- woods	2003-13	78-05787	59,90		
KVF650 Prairie	2002-03	78-05787	59,90		
KVF650 Brute Force/ Hardwoods Green 4X4	2005-13	78-05787	59,90		
KVF700 Team Green SE 4X4	2005	78-05787	59,90		
KVF750 Brute Force/ Hardwoods Green 4X4	2005-12	78-05787	59,90		
POLARIS					
Xplorar 4x4	2000	78-05765	59,90	78-05766	59,90
Magnum 325 2x4/4x4	2000	78-05765	59,90	78-05766	59,90
Magnum 500	2000			78-05766	59,90
Scrambler 400 2x4	2000	78-05765	59,90		
Scrambler 400 4x4	1998-01	78-05765	59,90	78-05766	59,90
Scrambler 500L	1998-00	78-05765	59,90	78-05766	59,90
Sport 400L	1999-00	78-05765	59,90	78-05766	59,90
Trail Blazer 250	1999-06	78-05765	59,90		
Trail Boss 325	2000	78-05765	59,90	78-05766	59,90
Trail Boss 325	2003	78-05765	59,90		
Trail Boss 330	2003-04	78-05765	59,90		
Xpedition 325	2000	78-05765	59,90	78-05766	59,90
Trail Blazer 400	2003	78-05765	59,90		
325 Magnum	2002	78-05988	59,90	78-05990	59,90
330 ATP	2004-05	78-05988	59,90	78-05990	59,90
330 Magnum	2003-04	78-05988	59,90	78-05990	59,90
Sportsman 400 HO	2011-12	78-05988	59,90	78-05991	59,90
Xpedition 4x4 425	2000			78-05766	59,90



Malli	Vuosim.	Eteen		Taakse	
		Tuoteno.	Hinta	Tuoteno.	Hinta
POLARIS					
Sportsman 450	2006	78-05988	59,90	78-05991	59,90
Sportsman 450	2007	78-05988	59,90	78-05991	59,90
ATV Pro 500 4x4 PPS	2002	78-05988	59,90	78-05990	59,90
Magnum 500 4x4 HDS	2003-05	78-05988	59,90	78-05990	59,90
Sportsman 500 HO/EFI	2003-06	78-05988	59,90	78-05991	59,90
Sportsman 500 EFI	2007-08	78-05988	59,90	78-05991	59,90
Sportsman 500 X2	2006-08	78-05988	59,90	78-05991	59,90
Sportsman 6x6 Big Boss	2000-08	78-05988	59,90		
Sportsman 500 EFI Intl	2007-09	78-05988	59,90	78-05991	59,90
Sportsman X 2 500 EFI	2007-09	78-05988	59,90	78-05991	59,90
Sportsman 500 Touring	2008-09	78-05988	59,90	78-05991	59,90
Sportsman X 2 500 EFI Quad	2008-09	78-05988	59,90	78-05991	59,90
Sportsman 600 4x4	2003-05	78-05988	59,90	78-05991	59,90
Sportsman 700 4x4/EFI	2002-06	78-05988	59,90	78-05991	59,90
Sportsman MV 700	2005-06	78-05988	59,90	78-05991	59,90
Sportsman 700 EFI	2007	78-05988	59,90	78-05991	59,90
Sportsman X 2 800 EFI	2007	78-05988	59,90	78-05991	59,90
Sportsman 800 EFI/HO/Touring	2007-09	78-05988	59,90	78-05991	59,90
Sportsman 800 6X6	2009	78-05988	59,90	78-05991	59,90
PPS/PTV 4x4 Series 10		78-05988	59,90	78-05990	59,90
PPS/Series 11 2x4, 4x4, 6x6		78-05988	59,90	78-05991	59,90
Ranger Series 10/"500 4x4"		78-05988	59,90	78-05991	59,90
Ranger 500 2x4, 4x4	2006-09	78-05988	59,90	78-05991	59,90
Ranger 500 (4x4 EFI)	2006-13	78-05988	59,90	78-05991	59,90
Ranger Series 11		78-05988	59,90	78-05991	59,90
Ranger 6x6	2004-05	78-05988	59,90	78-05991	59,90
Ranger 6x6 EFlI 700	2006	78-05988	59,90	78-05991	59,90
Ranger TM	2004-05	78-05988	59,90	78-05991	59,90
Ranger TM	2006	78-05988	59,90	78-05991	59,90
Ranger XP	2005	78-05988	59,90	78-05991	59,90
Ranger XP 700 4x4	2006	78-05988	59,90	78-05991	59,90
Ranger 700 6x6 EFI	2006-09	78-05988	59,90	78-05991	59,90
Ranger 700 4x4 EFI/Crew/6x4	2008-09	78-05988	59,90	78-05991	59,90
SUZUKI					
LT-A 400 Eiger 4WD	2002-07	78-05784	59,90		
LT-A 400 Eiger 2WD	2002-04/06	78-05784	59,90		
LT-F 400 Eiger 4WD	2002-08	78-05784	59,90		
LT-F 400 Eiger 2WD	2002-04	78-05784	59,90		
LT-A 400 KING QUAD	2008-11	78-05784	59,90		
LT-A 450 King Quad	2007-10	78-05786	59,90		
LT-A 450 King Quad	2003-07	78-05784	59,90		
LT-A 500 FK2/FK6 Vinson 4WD	2002-07	78-05784	59,90		
LT-A 500 FK3/FK4/FK5 Vinson 4WD	2003-07	78-05784	59,90		
LT-F 500 FW/FX/FY/FK1/FK2 Quadsport	1998-02	78-05784	59,90		
LT-A700 King Quad	2005-07	78-05786	59,90		
LT-V700 FK4/FK5 Twin Peaks 700 4X4	2004-05	78-05787	59,90		
LT-A750 King Quad	2008-11	78-05786	59,90		

Malli	Vuosim.	Eteen		Taakse	
		Tuoteno.	Hinta	Tuoteno.	Hinta
YAMAHA					
YFM125R RAPTOR RA/RB/RD	2011-13	78-05789	59,90		
YFS200 BLASTER	2003-06	78-05789	59,90		
YFS250 BEART-RACKER	2001-04	78-05789	59,90		
YFM250 BRUIN	2004-06	78-05790	59,90		
YFM250 XW BIG BEAR	2007-09	78-05790	59,90		
YFM250 RAPTOR	2008-13	78-05789	59,90		
YFM350 WARRIOR	1988-89	78-05789	59,90		
YFM350 WARRIOR	1990-04	78-05789	59,90		
YFM350 BRUIN 2X4/4X4	2004-06	78-05789	59,90		
YFM350 WOLVERINE	1995-05	78-05791	59,90		
YFM350 WOLVERINE	2006-09	78-05790	59,90		
YFM350 GRIZZLY 2WD	2007-11	78-05790	59,90		
YFM350 GRIZZLY AUTO IRS 4X4	2007-13	78-05790	59,90		
YFZ350 BANSHEE	1987-89	78-05789	59,90		
YFZ350 BANSHEE	1990-06	78-05789	59,90		
YFM350 RAPTOR	2004-12	78-05789	59,90		
YFM400 FWBL KODIAK	1999	78-05791	59,90		
YFM400 2X4 BIG BEAR	2003-04	78-05791	59,90		
YFM 400 KODIAK	2000-02	78-05791	59,90		
YFM400 KODIAK 4X4/HUNTER	2000-02	78-05791	59,90		
YFM400 KODIAK 2X4	2000-01	78-05791	59,90		
YFM400 KODIAK 2WD	2003-04	78-05790	59,90		
YFM400 KODIAK 4X4 AUTO	2005-06	78-05790	59,90	78-05797	59,90
YFM 400 GRIZZLY	2007-11	78-05790	59,90	78-05797	59,90
YFM400 BIG BEAR 2X4	2000-02	78-05791	59,90		
YFM400 BIG BEAR	2000-01	78-05791	59,90		
YFM400 BIG BEAR/Real Tre-Tra	2000-05	78-05791	59,90		
YFM400 BIG BEAR BUCKMASTER	2001	78-05791	59,90		
YFM400 BIG BEAR 2X4/4X4	2004-06	78-05791	59,90		
YFM400 BIG BEAR 2X4/4X4	2007-12	78-05790	59,90		
YFM 450 FAR/FAS KODIAK	2003-04	78-05790	59,90		
YFM 450 WOLVERINE	2006-10	78-05790	59,90	78-05797	59,90
YFM 450 KODIAK	2005-07	78-05790	59,90	78-05797	59,90
YFM 450 GRIZZLY	2007-13	78-05790	59,90	78-05797	59,90
YFZ450	2004-05	78-05789	59,90		
YFZ450	2006-12	78-05789	59,90		
YFZ450 SEW/SPX	2007-08	78-05789	59,90		
YFZ450	2006-10				
YFM550 Grizzly	2007-11			78-05994	59,90
YFM660 RAPTOR	2001-05	78-05789	59,90		
YFM700 Grizzly	2007-11			78-05994	59,90
YFM700 RAPTOR	2006-13	78-05789	59,90		

KETJUHINNAT

Regina on yli 300 maailmanmestaruudellaan todistetusti ketjujen aatelia. Lisää ketjuvaihtoehtoja crossi-sivuilla.



Ehkä ajatkin jo Reginan ketjuilla?

Valmistajat luottavat Reginaan vahvasti. Se on mm. seuraavien valmistajien ensiasennusketju:



	REGINA PROFESSIONAL	
415 ORO	BASIC	Moped
281-41502-110	Regina 415 ORO	17,50
281-41502-120	Regina 415 ORO	19,00
281-41502-C	Jousilukko 415 ORO	2,50
420 OROY	BASIC	Moped
281-42002-088	Regina 420 ORO	15,00
281-42002-090	Regina 420 ORO	15,50
281-42002-120	Regina 420 ORO	20,00
281-42002-130	Regina 420 ORO	21,50
281-42002-136	Regina 420 ORO	22,50
281-42002-140	Regina 420 ORO	23,00
281-42002-ORO	Regina 420 ORO 10M/Rulla	119,50
281-42002-C	Jousilukko ORO 4,08MM	2,50
420 RH2	PREMIUM	Cross/Supermotard/Street
281-42020-140	Regina 420 RH2	36,50
281-42020-C	Jousilukko RH2	4,50
420 RX3	ULTRA	Cross/Supermotard
281-42006-140	Regina 420 RX3	43,00
281-42006-146	Regina 420 RX3	44,50
281-42006-RX3	Regina 420 RX3 10M/Rulla	224,50
281-42006-C	Jousilukko RX3	4,50
428 EB-ORO	BASIC	Street/Enduro
281-42801-114	Regina 428 EB	25,00
281-42801-130	Regina 428 EB	28,50
281-42801-134	Regina 428 EB	29,50
281-42801-140	Regina 428 EB	31,00
281-42801-C	Regina Jousilukko 428EB	2,50
428 RH2	PREMIUM	Cross/Supermotard/Street
281-42820-118	REGINA 428 RH2	49,00
281-42820-120	REGINA 428 RH2	49,50
281-42820-124	REGINA 428 RH2	52,00
281-42820-126	REGINA 428 RH2	52,50
281-42820-128	REGINA 428 RH2	53,50
281-42820-130	REGINA 428 RH2	54,50
281-42820-132	REGINA 428 RH2	55,00
281-42820-134	REGINA 428 RH2	56,00
281-42820-136	REGINA 428 RH2	56,50
281-42820-140	REGINA 428 RH2	58,50
281-42820-146	REGINA 428 RH2	61,00
281-42820-C	Jousilukko 428RH2	3,50
281-42820-R	Jousilukko 428RH2	2,50
520 RH2	PREMIUM	Cross/Supermotard/Street
281-52003-106	Regina 520 RH2	63,00
281-52003-108	Regina 520 RH2	64,00
281-52003-110	Regina 520 RH2	65,00
281-52003-112	Regina 520 RH2	66,50
281-52003-114	Regina 520 RH2	67,50
281-52003-120	Regina 520 RH2	71,00
281-52003-RH	Regina 520 RH2 10M/Rulla	346,00
281-52003-C	Jousilukko 520RH2	4,50

520 RX3	ULTRA	Cross/Motard
281-52006-120	REGINA 520 RX3	87,00
281-52006-RX3	REGINA 520 RX3 10M/Rulla	422,00
281-52006-C	Jousilukko 520RX3	5,50
281-52006-R	Niittilukko 520RX3	4,50
520 ORN6	TOP	Street/Enduro
281-52008-098	Regina 520 ORN O-rengasketju	83,50
281-52008-102	Regina 520 ORN O-rengasketju	87,00
281-52008-104	Regina 520 ORN O-rengasketju	88,50
281-52008-106	Regina 520 ORN O-rengasketju	90,50
281-52008-108	Regina 520 ORN O-rengasketju	92,00
281-52008-110	Regina 520 ORN O-rengasketju	93,50
281-52008-112	Regina 520 ORN O-rengasketju	95,50
281-52008-114	Regina 520 ORN O-rengasketju	97,00
281-52008-120	Regina 520 ORN O-rengasketju	102,50
281-52008-C	Jousilukko 520 ORN	6,50
281-52008-R	Niittilukko 520 ORN	4,50
520 ZRE	ULTRA	Enduro
281-52021-110	REGINA 520 ZRE Z-rengasketju	123,00
281-52021-112	REGINA 520 ZRE Z-rengasketju	125,00
281-52021-116	REGINA 520 ZRE Z-rengasketju	129,50
281-52021-120	REGINA 520 ZRE Z-rengasketju	134,00
281-52021-C	Jousilukko 520 ZRE	8,50
281-52021-R	Niittilukko 520 ZRE	6,50
	REGINA EXTRA ERIKOISKETJUT	
520 GPXV	EXTRA OFFROAD	CROSS/SUPERMOTARD/RACING
281-520G3-120	Regina 520 GPXV	159,00
281-520G3-R	Niittilukko GPXV	6,50
520 EBSORO	EXTRA OFFROAD	SPEEDWAY
281-52002-120	Regina 520 EBS-120/S-W Rear Drivet	64,00
281-52002-C	Jousilukko 520EBS/S-W	4,50
281-52002-R	Niittilukko 520EBS/S-W	2,50
428 SP3	EXTRA OFFROAD	SPEEDWAY
281-42805-062	Regina 428 SP3 Primary drive	53,00
281-42805-064	Regina 428 SP3 Primary drive	54,50
281-42805-066	Regina 428 SP3 Primary drive	56,00
281-42805-068	Regina 428 SP3 Primary drive	57,50
281-42805-070	Regina 428 SP3 Primary drive	59,00
281-42805-R	Niittilukko SP3	4,50
520 QUAD	EXTRA OFFROAD	ATV
281-52013-088	REGINA 520 QUAD Z-rengasketju	119,00
281-52013-090	REGINA 520 QUAD Z-rengasketju	121,50
281-52013-096	REGINA 520 QUAD Z-rengasketju	129,50
281-52013-100	REGINA 520 QUAD Z-rengasketju	135,00
281-52013-116	REGINA 520 QUAD Z-rengasketju	157,00
281-52013-C	Jousilukko QUAD	9,50
281-52013-R	Niittilukko QUAD	7,50



Vanteet ja renkaat



Talvituotteet



Vinssit



Laukut ja tuulisuojat



Sähköosat



Jousitus ja voimansiirto



Pakoputket ja suutinsarjat



Ohjaukset



Runnon osat ja peitteet



Jarrupalat ja rattaat



Moottori



Variaattorin osat



Maatalous-tarvikkeet



Kärryt ja reet

ATV





RK

Racing Chain

KETJUT

Japanilainen RK on yksi maailman suurimmista ketjujen valmistajista. RK:n ketjut edustavat huippuunsa hiottua laatua ja kaikki japanilaiset moottoripyörävalmistajat, sekä eurooppalaisista mm. KTM, Ducati ja Triumph ovatkin valinneet RK:n alkuperäisketjuksi moottoripyöriinsä.



Markkinoiden parhaat O-rengasketjut tekee RK. Saatavana 420,428 ja 520 -tyyppisinä. Jopa 3 kertaa pidempi käyttöikä kuin tavallisilla ketjuilla.

XW-rengasketjut todella kovaan ajoon. Äärimmäinen suorituskyky ja kestävyys. Kehitetty erityisesti ATV käyttöön. Erittäin korkea lämmön-sietokyky.

420 SO	ATV -125cc	OVH
282-420180-132	RK 420SO O-rengasketju	55,00
282-420180-140	RK 420SO O-rengasketju	59,00
282-420180-146	RK 420SO O-rengasketju	61,00
428 SO	ATV -200cc	OVH
282-428180-120	RK 428SO O-rengasketju	65,00
282-428180-124	RK 428SO O-rengasketju	67,00
282-428180-126	RK 428SO O-rengasketju	68,00
282-428180-130	RK 428SO O-rengasketju	70,00
282-428180-132	RK 428SO O-rengasketju	71,00
282-428180-134	RK 428SO O-rengasketju	72,00
282-428180-140	RK 428SO O-rengasketju	75,00
282-428180-146	RK 428SO O-rengasketju	78,00
520 SO	ATV -400cc	OVH
282-520180-106	RK 520SO O-rengasketju	76,00
282-520180-108	RK 520SO O-rengasketju	77,50
282-520180-110	RK 520SO O-rengasketju	79,00
282-520180-112	RK 520SO O-rengasketju	80,50
282-520180-114	RK 520SO O-rengasketju	82,00
282-520180-116	RK 520SO O-rengasketju	83,50

520 SO	ATV -400cc	OVH
282-520180-118	RK 520SO O-rengasketju	85,00
282-520180-120	RK 520SO O-rengasketju	86,50
GB 520 EXW	ATV -750cc	OVH
282-520201-088	GB520EXW XW-rengasketju Atv Kulta	87,00
282-520201-090	GB520EXW XW-rengasketju Atv Kulta	90,00
282-520201-096	GB520EXW XW-rengasketju Atv Kulta	96,00
282-520201-100	GB520EXW XW-rengasketju Atv Kulta	100,00
282-520201-116	GB520EXW XW-rengasketju Atv Kulta	118,00
282-520201-120	GB520EXW XW-rengasketju Atv Kulta	120,00
KETJULUKOT		OVH
282-420180-CL	RK 420SO Ketjulukko	4,00
282-420180-CLF	RK 420SO Niittilukko	4,00
282-428180-CL	RK 428SO Ketjulukko	4,00
282-428180-CLF	RK 428SO Niittilukko	4,00
282-520180-CL	RK 520SO Jousilukko	4,50
282-520180-CLF	RK 520SO Niittilukko	4,50
282-520201-CL	GB520EXW Jousilukko	5,00
282-520201-CLF	GB520EXW Niittilukko	5,00

D.I.D.[®]

Racing Chain
Powered by Technology



KETJUT

Japanilainen D.I.D on yksi maailman johtavista ketjujen valmistajista ja sen mallisto on yksi markkinoiden kattavimmista. D.I.D myös toimittaa lukuisille moottoripyörävalmistajalle OEM-ketjut.

D.I.D näkyvästi esillä kilpaurheilussa ja on auttanut vuosien varrella monet kilpakuljettajat voittoon, tunnetuimpina Valentino Rossi, Jorge Lorenzo ja Ryan Villopoto.



Tuoteno.	Perusketju mopoihin/ mönkijöihin -85cc	Ovh
283-420001-088	D.I.D 420D Ketju+Jousil. (RJ)	13,20
283-420001-090	D.I.D 420D Ketju+Jousil. (RJ)	13,50
283-420001-120	D.I.D 420D Ketju+Jousil. (RJ)	18,00
283-420001-130	D.I.D 420D Ketju+Jousil. (RJ)	19,50
283-420001-140	D.I.D 420D Ketju+Jousil. (RJ)	21,00
283-420001-RJ	D.I.D 420D Jousilukko (RJ)	1,50
Tuoteno.	O-rengasketju 50-125cc	Ovh
283-420015-140	D.I.D 420V Ketju+Jousil. (RJ)	75,00
283-420015-RJ	D.I.D 420V Jousilukko (RJ)	4,00
283-420015-ZJ	D.I.D 420V Niittilukko (ZJ)	4,00
Tuoteno.	Vahvistettu ketju	Ovh
283-428002-118	D.I.D 428HD Ketju+Jousil. (RJ)	32,00
283-428002-120	D.I.D 428HD Ketju+Jousil. (RJ)	32,50
283-428002-124	D.I.D 428HD Ketju+Jousil. (RJ)	34,50
283-428002-126	D.I.D 428HD Ketju+Jousil. (RJ)	35,00
283-428002-128	D.I.D 428HD Ketju+Jousil. (RJ)	35,50
283-428002-130	D.I.D 428HD Ketju+Jousil. (RJ)	36,00
283-428002-132	D.I.D 428HD Ketju+Jousil. (RJ)	37,00
283-428002-134	D.I.D 428HD Ketju+Jousil. (RJ)	38,00
283-428002-136	D.I.D 428HD Ketju+Jousil. (RJ)	39,00
283-428002-140	D.I.D 428HD Ketju+Jousil. (RJ)	40,00
283-428002-146	D.I.D 428HD Ketju+Jousil. (RJ)	41,00
283-428002-RJ	D.I.D 428HD Jousilukko (RJ)	2,00

Tuoteno.	X-rengasketju	Ovh
283-428040-124	D.I.D 428VX Ketju+Jousil. (FJ)	83,50
283-428040-132	D.I.D 428VX Ketju+Jousil. (FJ)	89,00
283-428040-134	D.I.D 428VX Ketju+Jousil. (FJ)	90,00
283-428040-140	D.I.D 428VX Ketju+Jousil. (FJ)	94,00
283-428040-146	D.I.D 428VX Ketju+Jousil. (FJ)	98,00
283-428040-FJ	D.I.D 428VX Jousilukko (FJ) Press-Fit	4,50
283-428040-ZJ	D.I.D 428VX Niittilukko (ZJ)	4,50
Tuoteno.	Offroad&Streetketju 125-450cc	Ovh
283-520075-106	D.I.D 520DZ2 G&B Ketju+Jousil. (RJ)	59,00
283-520075-108	D.I.D 520DZ2 G&B Ketju+Jousil. (RJ)	60,00
283-520075-110	D.I.D 520DZ2 G&B Ketju+Jousil. (RJ)	61,00
283-520075-112	D.I.D 520DZ2 G&B Ketju+Jousil. (RJ)	62,50
283-520075-114	D.I.D 520DZ2 G&B Ketju+Jousil. (RJ)	63,50
283-520075-116	D.I.D 520DZ2 G&B Ketju+Jousil. (RJ)	64,50
283-520075-120	D.I.D 520DZ2 G&B Ketju+Jousil. (RJ)	67,00
283-520075-RJ	D.I.D 520DZ2 G&B Jousilukko (RJ)	3,50
283-520075-ZJ	D.I.D 520DZ2 G&B Niittilukko (ZJ)	3,50

Tuoteno.	X-rengasketju 125-750cc	Ovh
283-520040-100	D.I.D 520VX2 Ketju+Jousil. (FJ)	83,00
283-520040-102	D.I.D 520VX2 Ketju+Jousil. (FJ)	85,00
283-520040-104	D.I.D 520VX2 Ketju+Jousil. (FJ)	86,00
283-520040-106	D.I.D 520VX2 Ketju+Jousil. (FJ)	89,00
283-520040-108	D.I.D 520VX2 Ketju+Jousil. (FJ)	90,00
283-520040-110	D.I.D 520VX2 Ketju+Jousil. (FJ)	92,00
283-520040-112	D.I.D 520VX2 Ketju+Jousil. (FJ)	93,00
283-520040-114	D.I.D 520VX2 Ketju+Jousil. (FJ)	94,00
283-520040-116	D.I.D 520VX2 Ketju+Jousil. (FJ)	95,00
283-520040-120	D.I.D 520VX2 Ketju+Jousil. (FJ)	99,00
283-520040-FJ	D.I.D 520VX2 Jousilukko (FJ) Press-Fit	6,00
283-520040-ZJ	D.I.D 520VX2 Niittilukko (ZJ)	6,00
Tuoteno.	ATV Racing X-ring Max 750cc	Ovh
283-520070-088	D.I.D 520ATV G&B Ketju+Jousil. (FJ)	90,00
283-520070-090	D.I.D 520ATV G&B Ketju+Jousil. (FJ)	93,00
283-520070-096	D.I.D 520ATV G&B Ketju+Jousil. (FJ)	99,00
283-520070-100	D.I.D 520ATV G&B Ketju+Jousil. (FJ)	105,00
283-520070-116	D.I.D 520ATV G&B Ketju+Jousil. (FJ)	120,00
283-520070-FJ	D.I.D 520ATV G&B Jousilukko (FJ) Press-Fit	8,00
283-520070-ZJ	D.I.D 520ATV G&B Niittilukko (ZJ)	8,00



			Eturatas		Takaratas		KETJU	REGINA	RK	D.I.D
CAN-AM			Til.no.		Til.no.		Tyyppi/pit.	Til.no.	Til.no.	Til.no.
DS 450	08		27-1-394-14		27-2-1421-40		520-102	281-52013-116	282-520201-116	283-520070-116
DS 650 X	04-07		27-1-3411-16				530-			
HONDA			Til.no.		Til.no.		Tyyppi/pit.	Til.no.		
TRX90 X	09-12		27-1-277-13		27-2-1355-50		428-98	281-42820-118	282-428151-116	283-428002-118
TRX90 X	13-14		27-1-277-13		27-2-1355-50		428-100	281-42820-118	282-428151-116	283-428002-118
TRX 250 X	87-88		27-1-1352-13		27-2-1350-38		520-86	281-52013-088	282-520201-088	283-520070-088
TRX 250 R	91-92		27-1-1352-13		27-2-1350-38		520-86	281-52013-088	282-520201-088	283-520070-088
TRX 300 EX Fourtrax	93-08		27-1-1352-13		27-2-1350-38		520-86	281-52013-088	282-520201-088	283-520070-088
TRX 300 X	09		27-1-1352-13		27-2-1350-38		520-86	281-52013-088	282-520201-088	283-520070-088
TRX 400 EX Sportrax	99-04		27-1-1322-15		27-2-1350-38		520-94	281-52013-096	282-520201-096	283-520070-096
TRX 400 EX Sportrax	05-08		27-1-1309-14		27-2-1350-39		520-94	281-52013-096	282-520201-096	283-520070-096
TRX 400 X	09-14		27-1-1309-14		27-2-1350-39		520-94	281-52013-096	282-520201-096	283-520070-096
TRX 450 R	04-05		27-1-284-14		27-2-1350-38		520-96	281-52013-096	282-520201-096	283-520070-096
TRX 450 ER,R	06-14		27-1-284-13		27-2-1350-38		520-96	281-52013-096	282-520201-096	283-520070-096
KAWASAKI			Til.no.		Til.no.		Tyyppi/pit.	Til.no.		
KSF 80 (KFX80)	03-06		27-1-1407-10		27-2-1795-22		520-36	281-52003-106	282-520180-106	283-520075-106
KSF 400 (KFX 400)	03-06		27-1-1401-14		27-2-1826-40		520-112	281-52013-116	282-520201-116	283-520070-116
KSF 450 (KFX 450)	08-14		27-1-1536-14		27-2-1415-38		520-94	281-52013-096	282-520201-096	283-520070-096
KYMCO			Til.no.		Til.no.		Tyyppi/pit.	Til.no.		
50 Mxer	02-04		27-1-327-14		27-2-1071-30		520-78	281-52013-088	282-520201-088	283-520070-088
50 MXU	04-07		27-1-327-14		27-2-1071-30		520-78	281-52013-088	282-520201-088	283-520070-088
50 MXU Reverse	07-08		27-1-327-14		27-2-1071-30		520-86	281-52013-088	282-520201-088	283-520070-088
150 Mxer/MXU	02-05		27-1-1041-14		27-2-1071-30		520-78	281-52013-088	282-520201-088	283-520070-088
250 KXR	02-		27-1-1042-14		27-2-1072-38		520-94	281-52013-096	282-520201-096	283-520070-096
300 Maxxer	05-08		27-1-1042-14		27-2-1072-38		520-92	281-52013-096	282-520201-096	283-520070-096
POLARIS			Til.no.		Til.no.		Tyyppi/pit.	Til.no.		
250 Cyclone	87	C/S	27-1-3221-13	REAR	27-2-1478-42		520-74	281-52013-088	282-520201-088	283-520070-088
250 Scrambler	85-86	C/S	27-1-3221-13	REAR	27-2-1478-42		520-74	281-52013-088	282-520201-088	283-520070-088
250 Trail Blazer (W7221)	90	C/S	27-1-3221-13	REAR	27-2-1478-42		520-88	281-52013-088	282-520201-088	283-520070-088
250 Trail Blazer (W7221)	91	C/S	27-1-3221-13	REAR	27-2-1478-34		520-84	281-52013-088	282-520201-088	283-520070-088
250 Trail Blazer (W7221)	92	C/S	27-1-3221-11	REAR	27-2-1478-34		520-84	281-52013-088	282-520201-088	283-520070-088
250 Trail Blazer (W7221)	93	C/S	27-1-3221-11	REAR	27-2-1478-38		520-86	281-52013-088	282-520201-088	283-520070-088
250 Trail Blazer (W7221)	94	C/S	27-1-3221-11	REAR	27-2-1478-40		520-86	281-52013-088	282-520201-088	283-520070-088
250 Trail Blazer (W7221)	95	C/S	27-1-3221-12	REAR	27-2-1478-42		520-88	281-52013-088	282-520201-088	283-520070-088
250 Trail Blazer ES	96-99	C/S	27-1-3221-12	REAR	27-2-1478-42		520-88	281-52013-088	282-520201-088	283-520070-088
250 Trail Blazer	00	C/S	27-1-3221-11	REAR	27-2-1478-38		520-	281-52013-	282-520201-	283-520070-
250 Trail Blazer (valm.ennen 7/15/00)	01	C/S	27-1-3221-11	REAR	27-2-1478-38		520-	281-52013-	282-520201-	283-520070-
250 Trail Blazer (valm.jälkeen 7/15/00)	01	C/S	27-1-3221-11	REAR	27-2-1478-36		520-	281-52013-	282-520201-	283-520070-
250 Trail Blazer	02-03	C/S	27-1-3221-11	REAR	27-2-1478-36		520-76	281-52013-088	282-520201-088	283-520070-088
250 Trail Boss (W8527)	85-89	C/S	27-1-3221-13	REAR	27-2-1478-42		520-88	281-52013-088	282-520201-088	283-520070-088
250 Trail Boss (W8527)	90	C/S	27-1-3221-13	REAR	27-2-1478-38		520-86	281-52013-088	282-520201-088	283-520070-088
250 Trail Boss (W8527)	91-93	C/S	27-1-3221-13	REAR	27-2-1478-34		520-84	281-52013-088	282-520201-088	283-520070-088
250 Trail Boss (W8527)	94	C/S	27-1-3221-11	REAR	27-2-1478-40		520-86	281-52013-088	282-520201-088	283-520070-088
250 Trail Boss (W8527)	95-99	C/S	27-1-3221-12	REAR	27-2-1478-42		520-88	281-52013-088	282-520201-088	283-520070-088
250 Trail Boss 2 x 4 (W7527)	85	C/S	27-1-3221-13	REAR	27-2-1478-38		520-	281-52013-	282-520201-	283-520070-
250 Trail Boss 2 x 4 (W7527)	86-87	C/S	27-1-3221-13	REAR	27-2-1478-42		520-74	281-52013-088	282-520201-088	283-520070-088

Rataskaaviot Polaris-mönkijöihin

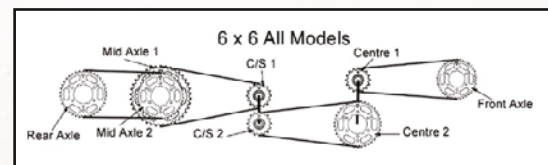
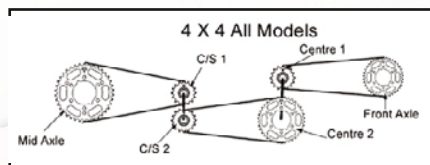
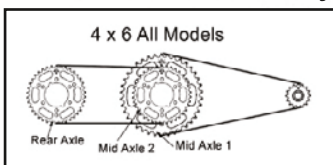

RATTAAT JA KETJUT JATKUU



POLARIS			Eturatas Til.no.		Takaratas Til.no.	KETJU Tyyppi/pit.	Til.no.		
250 Trail Boss 2 x 4 (W7527)	88-93	C/S	27-1-3221-13	REAR	27-2-1478-38	520-86	281-52013-088	282-520201-088	283-520070-088
250 Trail Boss 4 x 4 (W8127)	87-88	C/S 1	27-1-3221-12	MID AXLE 1	27-2-1478-42	520-74	281-52013-088	282-520201-088	283-520070-088
		C/S 2				520-76	281-52013-088	282-520201-088	283-520070-088
		FRONT AXLE				520-64	281-52013-088	282-520201-088	283-520070-088
		CENTRE 1	27-1-3221-11						
		CENTRE 2	27-1-3323-22						
250 Trail Boss 4 x 4	89-92	C/S 1	27-1-3221-12	MID AXLE 1	27-2-1478-42	520-88	281-52013-088	282-520201-088	283-520070-088
		C/S 2	27-1-3222-11			520-70	281-52013-088	282-520201-088	283-520070-088
		FRONT AXLE	27-1-3323-22			520-64	281-52013-088	282-520201-088	283-520070-088
		CENTRE 1	27-1-3221-11						
		CENTRE 2	27-1-3323-22						
250 4 x 4	93	C/S 1	27-1-3221-12	MID AXLE 1	27-2-1478-42	520-88	281-52013-088	282-520201-088	283-520070-088
		C/S 2	27-1-3222-11			520-70	281-52013-088	282-520201-088	283-520070-088
		FRONT AXLE	27-1-3323-22			520-64	281-52013-088	282-520201-088	283-520070-088
		CENTRE 1	27-1-3221-11						
		CENTRE 2	27-1-3323-22						
250 Big Boss 4 x 6	89	C/S	27-1-3221-13	MID AXLE 1	27-2-1478-42	520-88	281-52013-088	282-520201-088	283-520070-088
				MID AXLE 2	27-2-1478-30	520-108	281-52013-116	282-520201-116	283-520070-116
				REAR AXLE	27-2-1478-30				
250 Big Boss 4 x 6	90-92	C/S	27-1-3221-12	MID AXLE 1	27-2-1478-42	520-88	281-52013-088	282-520201-088	283-520070-088
				MID AXLE 2	27-2-1478-30	520-108	281-52013-116	282-520201-116	283-520070-116
				REAR AXLE	27-2-1478-30				
250 Big Boss 6 x 6 (W8727)	91-92	C/S 1	27-1-3222-12	MID AXLE 1	27-2-1478-42	520-88	281-52013-088	282-520201-088	283-520070-088
		C/S 2				520-72	281-52013-088	282-520201-088	283-520070-088
		FRONT AXLE	27-1-3323-22			520-64	281-52013-088	282-520201-088	283-520070-088
		CENTRE 1	27-1-3221-11	MID AXLE 2	27-2-1478-30	520-108	281-52013-116	282-520201-116	283-520070-116
		CENTRE 2	27-1-3323-22	REAR AXLE	27-2-1478-30				
250 6 x 6	93	C/S 1	27-1-3221-12	MID AXLE 1	27-2-1478-42	520-88	281-52013-088	282-520201-088	283-520070-088
		C/S 2	27-1-3221-11			520-72	281-52013-088	282-520201-088	283-520070-088
		FRONT AXLE	27-1-3323-22			520-64	281-52013-088	282-520201-088	283-520070-088
		CENTRE 1	27-1-3221-11	MID AXLE 2	27-2-1478-30	520-108	281-52013-116	282-520201-116	283-520070-116
		CENTRE 2	27-1-3323-24	REAR AXLE	27-2-1478-30				
250 Xplorer 4x4	01-02	C/S	27-1-3221-12	REAR	27-2-1478-42	520-80	281-52013-088	282-520201-088	283-520070-088
300 2 x 4 (W7530)	95-96	C/S	27-1-3221-12	REAR	27-2-1478-38	520-86	281-52013-088	282-520201-088	283-520070-088
300 Xpress	96-99	C/S	27-1-3221-12	REAR	27-2-1478-38	520-86	281-52013-088	282-520201-088	283-520070-088
300 Xplorer 4 X 4	96-99	C/S 1	27-1-3221-13	MID AXLE 1	27-2-1478-40	520-84	281-52013-088	282-520201-088	283-520070-088
		C/S 2	27-1-3222-11			520-70	281-52013-088	282-520201-088	283-520070-088
		FRONT AXLE	27-1-3323-22			520-64	281-52013-088	282-520201-088	283-520070-088
		CENTRE 1	27-1-3221-12						
		CENTRE 2	27-1-3323-22						
300 4 x 4 (W8130)	94-95	C/S 1	27-1-3221-13	MID AXLE 1	27-2-1478-40	520-84	281-52013-088	282-520201-088	283-520070-088
		C/S 2	27-1-3222-11			520-70	281-52013-088	282-520201-088	283-520070-088
		FRONT AXLE	27-1-3323-22			520-64	281-52013-088	282-520201-088	283-520070-088
		CENTRE 1	27-1-3221-12						
		CENTRE 2	27-1-3323-22						
300 6 x 6	94	C/S 1	27-1-3221-13	MID AXLE 1	27-2-1478-42	520-88	281-52013-088	282-520201-088	283-520070-088
		C/S 2	27-1-3222-11			520-72	281-52013-088	282-520201-088	283-520070-088
		FRONT AXLE	27-1-3323-22			520-64	281-52013-088	282-520201-088	283-520070-088
		CENTRE 1	27-1-3221-11	MID AXLE 2	27-2-1478-30	520-108	281-52013-116	282-520201-116	283-520070-116
		CENTRE 2	27-1-3323-24	REAR AXLE	27-2-1478-30				
325 Trail Boss 2 x 4 (W7539)	00	C/S	27-1-3221-11	REAR	27-2-1478-42	520-80	281-52013-088	282-520201-088	283-520070-088
325 Trail Boss 2 x 4	01-02	C/S	27-1-3221-11	REAR	27-2-1478-40	520-78	281-52013-088	282-520201-088	283-520070-088
330 Trail Blazer 2 x 4	08-10	C/S	27-1-3221-11	REAR	27-2-1478-40	520-78	281-52013-088	282-520201-088	283-520070-088
330 Trail Boss 2 x 4	03-10	C/S	27-1-3221-11	REAR	27-2-1478-40	520-78	281-52013-088	282-520201-088	283-520070-088
350L Trail Boss 2 x 4 (W7539)	90-93	C/S	27-1-3221-13	REAR	27-2-1478-34	520-84	281-52013-088	282-520201-088	283-520070-088
350L Trail Boss 4 x 4 (W8139)	90-91	C/S 1	27-1-3221-12	MID AXLE 1	27-2-1478-34	520-84	281-52013-088	282-520201-088	283-520070-088
		C/S 2				520-70	281-52013-088	282-520201-088	283-520070-088
		FRONT AXLE	27-1-3323-22			520-64	281-52013-088	282-520201-088	283-520070-088
		CENTRE 1	27-1-3221-12						
		CENTRE 2	27-1-3323-22						
350L 4 x 4 (W8139)	92	C/S 1	27-1-3221-12	MID AXLE 1	27-2-1478-34	520-84	281-52013-088	282-520201-088	283-520070-088
		C/S 2	27-1-3222-11			520-70	281-52013-088	282-520201-088	283-520070-088
		FRONT AXLE	27-1-3323-22			520-64	281-52013-088	282-520201-088	283-520070-088
		CENTRE 1	27-1-3221-12						
		CENTRE 2	27-1-3323-22						
350L 4 x 4 (W8139)	93	C/S 1	27-1-3221-12	MID AXLE 1	27-2-1478-34	520-84	281-52013-088	282-520201-088	283-520070-088
		C/S 2	27-1-3222-11			520-70	281-52013-088	282-520201-088	283-520070-088
		FRONT AXLE	27-1-3323-22			520-64	281-52013-088	282-520201-088	283-520070-088

RATTAAT JA KETJUT JATKUU



POLARIS			Eturatas Til.no.		Takaratas Til.no.	KETJU Tyyppi/pit.	Til.no.		
		CENTRE 1	27-1-3221-11						
		CENTRE 2	27-1-3323-22						
350L Trail Boss/ Sportsman 4 x 4 (W8139)	93	C/S 1	27-1-3221-12	MID AXLE 1	27-2-1478-34	520-84	281-52013-088	282-520201-088	283-520070-088
		C/S 2	27-1-3222-11			520-70	281-52013-088	282-520201-088	283-520070-088
		FRONT AXLE	27-1-3323-22			520-64	281-52013-088	282-520201-088	283-520070-088
		CENTRE 1	27-1-3221-12						
		CENTRE 2	27-1-3323-22						
350L 6 x 6 (W8739)	93	C/S 1	27-1-3221-13	MID AXLE 1	27-2-1478-42	520-88	281-52013-088	282-520201-088	283-520070-088
		C/S 2	27-1-3222-11			520-70	281-52013-088	282-520201-088	283-520070-088
		FRONT AXLE	27-1-3323-22			520-64	281-52013-088	282-520201-088	283-520070-088
		CENTRE 1	27-1-3221-12	MID AXLE 2	27-2-1478-30	520-116	281-52013-116	282-520201-116	283-520070-116
		CENTRE 2	27-1-3323-22	REAR AXLE	27-2-1478-30				
400L 2 x 4 (W7540)	94-95	C/S	27-1-3221-13	REAR	27-2-1478-34	520-84	281-52013-088	282-520201-088	283-520070-088
400L 2 x 4 (W8140)	94	C/S	27-1-3221-13	REAR	27-2-1478-34	520-84	281-52013-088	282-520201-088	283-520070-088
400L Sport (W8540)	94-95	C/S	27-1-3221-12	REAR	27-2-1478-34	520-84	281-52013-088	282-520201-088	283-520070-088
400L Sport	96-99	C/S	27-1-3221-13	REAR	27-2-1478-34	520-84	281-52013-088	282-520201-088	283-520070-088
400 Xpress 2 x 4	96	C/S	27-1-3221-13	REAR	27-2-1478-34	520-84	281-52013-088	282-520201-088	283-520070-088
400L 4 x 4	94	C/S 1	27-1-3221-13	MID AXLE 1	27-2-1478-34	520-84	281-52013-088	282-520201-088	283-520070-088
		C/S 2	27-1-3222-11			520-70	281-52013-088	282-520201-088	283-520070-088
		FRONT AXLE	27-1-3323-22			520-64	281-52013-088	282-520201-088	283-520070-088
		CENTRE 1	27-1-3221-13						
		CENTRE 2	27-1-3323-22						
400 Scrambler 4 x 4 (W7840)	95	C/S 1	27-1-3222-11	MID AXLE 1	27-2-1478-38	520-84	281-52013-088	282-520201-088	283-520070-088
		C/S 2	27-1-3222-11			520-70	281-52013-088	282-520201-088	283-520070-088
		FRONT AXLE	27-1-3323-22			520-64	281-52013-088	282-520201-088	283-520070-088
		CENTRE 1	27-1-3221-12						
		CENTRE 2	27-1-3323-22						
400 Scrambler 4 x 4 (W7840)	96-99	C/S 1	27-1-3221-13	MID AXLE 1	27-2-1478-38	520-84	281-52013-088	282-520201-088	283-520070-088
		C/S 2	27-1-3222-11			520-70	281-52013-088	282-520201-088	283-520070-088
		FRONT AXLE	27-1-3323-22			520-64	281-52013-088	282-520201-088	283-520070-088
		CENTRE 1	27-1-3221-12						
		CENTRE 2	27-1-3323-22						
400 Scrambler 4 x 4	00	C/S	27-1-3221-13	REAR	27-2-1478-36	520-76	281-52013-088	282-520201-088	283-520070-088
400 Scrambler 2 x 4	00-02	C/S	27-1-3221-13	REAR	27-2-1478-36	520-76	281-52013-088	282-520201-088	283-520070-088
400 Sportsman 4 x 4 (W8040)	94-96	C/S 1	27-1-3221-13	MID AXLE 1	27-2-1478-34	520-84	281-52013-088	282-520201-088	283-520070-088
		C/S 2	27-1-3222-11			520-70	281-52013-088	282-520201-088	283-520070-088
		FRONT AXLE	27-1-3323-22			520-64	281-52013-088	282-520201-088	283-520070-088
		CENTRE 1	27-1-3221-13						
		CENTRE 2	27-1-3323-22						
400 Trail Blazer 2 x 4	03	C/S	27-1-3221-13	REAR	27-2-1478-36	520-76	281-52013-088	282-520201-088	283-520070-088
400 Xplorer 4 x 4 (W9140)	95-99	C/S 1	27-1-3221-13	MID AXLE 1	27-2-1478-34	520-84	281-52013-088	282-520201-088	283-520070-088
		C/S 2	27-1-3222-11			520-70	281-52013-088	282-520201-088	283-520070-088
		FRONT AXLE	27-1-3323-22			520-64	281-52013-088	282-520201-088	283-520070-088
		CENTRE 1	27-1-3221-13						
		CENTRE 2	27-1-3323-22						
400L '6 x 6 (W8740)	94-98	C/S 1	27-1-3221-13	MID AXLE 1	27-2-1478-42	520-88	281-52013-088	282-520201-088	283-520070-088
		C/S 2	27-1-3222-11			520-70	281-52013-088	282-520201-088	283-520070-088
		FRONT AXLE	27-1-3323-22			520-64	281-52013-088	282-520201-088	283-520070-088
		CENTRE 1	27-1-3221-13	MID AXLE 2	27-2-1478-30	520-116	281-52013-116	282-520201-116	283-520070-116
		CENTRE 2	27-1-3323-22	REAR AXLE	27-2-1478-30				
400 Scrambler	00-01	C/S	27-1-3221-13	REAR	27-2-1478-36	520-	281-52013-	282-520201-	283-520070-
425 Magnum 2 x 4 (W7544)	95-98	C/S	27-1-3221-12	REAR	27-2-1478-38	520-86	281-52013-088	282-520201-088	283-520070-088
425 Magnum 4 x 4 (W8144)	95-98	C/S 1	27-1-3221-12	MID AXLE 1	27-2-1478-38	520-86	281-52013-088	282-520201-088	283-520070-088
		C/S 2	27-1-3222-11			520-70	281-52013-088	282-520201-088	283-520070-088
		FRONT AXLE	27-1-3323-22			520-68	281-52013-088	282-520201-088	283-520070-088
		CENTRE 1	27-1-3221-11						
		CENTRE 2	27-1-3323-22						
425 Magnum 6 x 6	96	C/S 1	27-1-3221-12	MID AXLE 1	27-2-1478-42	520-88	281-52013-088	282-520201-088	283-520070-088
		C/S 2	27-1-3222-11			520-72	281-52013-088	282-520201-088	283-520070-088
		FRONT AXLE	27-1-3323-22			520-68	281-52013-088	282-520201-088	283-520070-088
		CENTRE 1	27-1-3221-11	MID AXLE 2	27-2-1478-30	520-116	281-52013-116	282-520201-116	283-520070-116
		CENTRE 2	27-1-3323-24	REAR AXLE	27-2-1478-30				
450 Outlaw MXR, S	08-10	C/S	27-1-1901-14	REAR	27-2-1480-38	520-98	281-52013-100	282-520201-100	283-520070-100
500 Scrambler	00-03	C/S	27-1-3221-13	REAR	27-2-1478-36	520-	281-52013-	282-520201-	283-520070-
		CENTRE 1	27-1-3221-11	MID AXLE 2	27-2-1478-30	520-116	281-52013-116	282-520201-116	283-520070-116
		CENTRE 2	27-1-3323-24	REAR AXLE	27-2-1478-30				
500 Scrambler 4 x 4	00-11	C/S	27-1-3221-13	REAR	27-2-1478-36	520-	281-52013-	282-520201-	283-520070-
500 Predator 500 E	03-05	C/S	27-1-1309-14		27-2-1480-37	520-94	281-52013-096	282-520201-096	283-520070-096
525 Outlaw MXR, S	08-10	C/S	27-1-1901-14	REAR	27-2-1480-38	520-98	281-52013-100	282-520201-100	283-520070-100
525 Outlaw IRS 2 x 4	10-11	C/S	27-1-1901-14	REAR		520-98	281-52013-100	282-520201-100	283-520070-100

RATTAAT JA KETJUT JATKUU



SUZUKI		Eturatas Til.no.	Takaratas Til.no.	KETJU Tyyppi/pit.	Til.no.		
LT 50	97-00	27-0075-11	27-2-801-37	420-64	281-42002-088	282-420100-088	283-420001-088
LT A-50	01	27-0075-11	27-2-801-37	420-78	281-42002-088	282-420100-088	283-420001-088
LT 80	89-06	27-1-1407-10	27-2-1795-22	520-36	281-52003-106	282-520180-106	283-520075-106
LT-F 160	91-01	27-1-1439-11	27-2-1826-39	520-84	281-52008-098	282-520180-106	283-520040-100
LT-F 160	02-04	27-1-1439-11		520-84	281-52008-098	282-520180-106	283-520040-100
LT 230 E	86-93	27-1-1439-11	27-2-1826-(41)	520-84	281-52008-098	282-520180-106	283-520040-100
LT 250R	85-90	27-1-432-12	27-2-1826-(42)	520-102	281-52013-116	282-520201-116	283-520070-116
LT-Z 400 QuadSport	03-09	27-1-1401-14	27-2-1826-40	520-96	281-52013-096	282-520201-096	283-520070-096
LT-R 450 QuadRacer	06-10	27-1-1401-14	27-2-1760-36	520-96	281-52013-096	282-520201-096	283-520070-096
YAMAHA		Eturatas Til.no.	Takaratas Til.no.	KETJU Tyyppi/pit.	Til.no.		
YFA1 125 Breeze	89-04	27-1-569-12	27-2-1910-32	520-74	281-52013-088	282-520201-088	283-520070-088
YFM 125 Grizzly	04-12	27-1-569-12	27-2-1910-32	520-74	281-52013-088	282-520201-088	283-520070-088
YFS 200 Blaster	88-98	27-1-1554-13	27-2-853-40	520-92	281-52013-096	282-520201-096	283-520070-096
YFS 200 Blaster	99-06	27-1-1554-13	27-2-853-40	520-92	281-52013-096	282-520201-096	283-520070-096
YFM 250 R Raptor	08-12	27-1-1593-14	27-2-1857-38	520-92	281-52013-096	282-520201-096	283-520070-096
YFM 350 Warrior	89-98	27-1-569-13	27-2-853-40	520-98	281-52013-100	282-520201-100	283-520070-100
YFM 350 Warrior	99-04	27-1-569-13	27-2-853-40	520-98	281-52013-100	282-520201-100	283-520070-100
YFM 350 RAPTOR	04-13	27-1-569-13	27-2-1857-38	520-98	281-52013-100	282-520201-100	283-520070-100
YFZ 450 S	04-09	27-1-565-14	27-2-1857-38	520-98	281-52013-100	282-520201-100	283-520070-100
YFZ 450 R	09-14	27-1-1592-14	27-2-1857-38	520-98	281-52013-100	282-520201-100	283-520070-100
YFM 660 Raptor	01-05	27-1-565-13	27-2-853-40	520-92	281-52013-096	282-520201-096	283-520070-096
YFM 700 RAPTOR	06-14	27-1-1592-14	27-2-1857-38	520-98	281-52013-100	282-520201-100	283-520070-100

RATTAAT JA KETJUT: HINNAT

Tuoteno.	Ovh.	Tuoteno.	Ovh.	Tuoteno.	Ovh.	Tuoteno.	Ovh.	Tuoteno.	Ovh.
27-0075-11	4,50	27-1-3222-12	21,40	27-2-1480-37	25,60	281-52008-104	88,50	283-420001-090	13,50
27-0075-12	4,50	27-1-326-12	14,60	27-2-1480-38	26,80	281-52008-106	90,50	283-420001-120	18,00
27-0075-13	4,50	27-1-327-12	13,60	27-2-1760-36	22,40	281-52008-108	92,00	283-420001-130	19,50
27-0075-14	4,50	27-1-327-13	13,60	27-2-1760-38	23,80	281-52008-110	93,50	283-420001-140	21,00
27-0075-15	4,50	27-1-327-14	13,60	27-2-1795-22	19,20	281-52008-112	95,50	283-428002-118	32,00
27-0075-16	4,50	27-1-327-15	13,60	27-2-1826-37	29,00	281-52008-114	97,00	283-428002-120	32,50
27-0075-17	4,50	27-1-3323-22	38,20	27-2-1826-39	29,00	281-52008-120	102,50	283-428002-124	34,50
27-1-1041-14	19,80	27-1-3323-24	38,20	27-2-1826-40	29,60	281-52013-088	119,00	283-428002-126	35,00
27-1-1042-14	20,60	27-1-3411-16	16,60	27-2-1826-41	30,00	281-52013-090	121,50	283-428002-128	35,50
27-1-1309-14	19,80	27-1-394-11	10,40	27-2-1826-42	30,00	281-52013-096	129,50	283-428002-130	36,00
27-1-1309-15	19,80	27-1-394-13	10,40	27-2-1857-38	24,80	281-52013-100	135,00	283-428002-132	37,00
27-1-1322-15	14,20	27-1-394-14	10,40	27-2-1910-32	26,00	281-52013-116	157,00	283-428002-134	38,00
27-1-1323-12	14,20	27-1-394-15	11,00	27-2-801-37	12,00	282-420100-088	14,50	283-428002-136	39,00
27-1-1352-13	11,00	27-1-394-16	11,40	27-2-853-40	26,60	282-420100-090	15,00	283-428002-140	40,00
27-1-1401-13	12,00	27-1-394-17	12,40	27-2-853-49	32,80	282-420100-120	19,50	283-428002-146	41,00
27-1-1401-14	12,00	27-1-432-13	16,60	27-2-853-50	32,80	282-420100-140	23,00	283-520040-100	83,00
27-1-1401-15	12,00	27-1-432-14	16,60	27-2-853-51	32,80	282-428151-116	37,00	283-520040-102	85,00
27-1-1407-10	9,80	27-1-432-15	18,20	281-42002-088	15,00	282-428151-118	37,50	283-520040-104	86,00
27-1-1439-11	10,40	27-1-565-13	10,40	281-42002-090	15,50	282-428151-120	38,00	283-520040-106	89,00
27-1-1439-12	10,40	27-1-565-14	10,40	281-42002-120	20,00	282-428151-124	39,00	283-520040-108	90,00
27-1-1536-14	21,80	27-1-565-15	8,80	281-42002-130	21,50	282-428151-126	39,50	283-520040-110	92,00
27-1-1536-15	21,80	27-1-565-16	8,80	281-42002-136	22,50	282-428151-130	40,00	283-520040-112	93,00
27-1-1536-16	22,40	27-1-569-12	9,40	281-42002-140	23,00	282-428151-132	40,50	283-520040-114	94,00
27-1-1554-13	20,20	27-1-569-13	9,40	281-42820-118	49,00	282-428151-134	41,00	283-520040-116	95,00
27-1-1592-13	21,20	27-1-569-14	9,40	281-42820-120	49,50	282-428151-136	41,50	283-520040-120	99,00
27-1-1592-14	21,20	27-1-569-15	9,80	281-42820-124	52,00	282-428151-140	42,50	283-520070-088	90,00
27-1-1592-15	21,20	27-1-569-16	9,80	281-42820-126	52,50	282-428151-146	44,50	283-520070-090	93,00
27-1-1593-14	16,60	27-1-569-17	11,40	281-42820-128	53,50	282-520180-106	76,00	283-520070-096	99,00
27-1-1901-12	14,20	27-2-1071-30	25,60	281-42820-130	54,50	282-520180-108	77,50	283-520070-100	105,00
27-1-1901-13	15,60	27-2-1072-38	28,00	281-42820-132	55,00	282-520180-110	79,00	283-520070-116	120,00
27-1-1901-14	16,20	27-2-1350-36	24,40	281-42820-134	56,00	282-520180-112	80,50	283-520075-106	59,00
27-1-1901-15	17,00	27-2-1350-38	24,40	281-42820-136	56,50	282-520180-114	82,00	283-520075-108	60,00
27-1-277-13	5,20	27-2-1350-39	26,40	281-42820-140	58,50	282-520180-116	83,50	283-520075-110	61,00
27-1-277-14	6,00	27-2-1355-50	31,00	281-42820-146	61,00	282-520180-118	85,00	283-520075-112	62,50
27-1-284-12	16,20	27-2-1415-38	23,80	281-52003-106	63,00	282-520180-120	86,50	283-520075-114	63,50
27-1-284-13	17,20	27-2-1421-40	30,60	281-52003-108	64,00	282-520201-088	87,00	283-520075-116	64,50
27-1-284-14	17,20	27-2-1478-34	25,60	281-52003-110	65,00	282-520201-090	90,00	283-520075-120	67,00
27-1-284-15	18,20	27-2-1478-36	25,60	281-52003-112	66,50	282-520201-096	96,00		
27-1-3221-11	20,80	27-2-1478-38	25,60	281-52003-114	67,50	282-520201-100	100,00		
27-1-3221-12	20,80	27-2-1478-40	26,40	281-52003-120	71,00	282-520201-116	118,00		
27-1-3221-13	20,80	27-2-1478-42	28,20	281-52008-098	83,50	282-520201-120	120,00		
27-1-3222-11	21,40	27-2-1478-43	28,20	281-52008-102	87,00	283-420001-088	13,20		



Vanteet ja renkaat



Talvituotteet



Vinssit



Laukut ja tuulisuojat



Sähköosat



Jousitus ja voimansiirto



Pakoputket ja suutinsarjat



Ohjaus



Rungon osat ja peitteet



Jarrupalat ja rattaat



Moottori



Variaattorin osat



Maatalous-tarvikkeet



Kärryt ja reet

ATV



Hollannista lähtöisin oleva Twin Air maailman johtava ilman- ja öljynsuodattimien valmistaja ja sen mallisto on yksi markkinoiden kattavimmista. Twin Air myös toimittaa yli 20 moottoripyörävalmistajalle OEM-suodattimet.

Twin Air näkyvästi esillä kilpaurheilussa ja on auttanut vuosien varrella monet kilpailijattajat voittoon, viimeisimpinä Jeffrey Herlings (MX2 luokan maailmanmestari) ja Eli Tomac (AMA Pro Motocross -sarjan mestari).



Malli	Vm	Ilmansuodatin	Hinta	Öljynsuodatin	Hinta
ARCTIC CAT					
DVX 400	03-08	201-15-3908	22,00	201-14-0007	5,50
Utility 400 4x4/Auto TBX	2004	201-15-8265FR	33,50	201-14-0006	9,50
Utility 400	05-11	201-15-8263	21,00	201-14-0006	9,50
TRV 400	09-14	201-15-8263	21,00	201-14-0006	9,50
500 TRV, FIS, TBX models	03-05	201-15-8265FR	33,50	201-14-0006	9,50
Utility 500	06-09	201-15-8263	21,00	201-14-0006	9,50
550 H1 EFI/XT/TRV	08-14	201-15-8268	18,00	-	-
Utility 650	04-12	201-15-8263	21,00	201-14-0015	9,50
650 H1 EFI	08-12	201-15-8268	18,00	-	-
700 EFI	06-08	201-15-8267	22,00	-	-
700 H1 EFI/TBX/XT/TRV/Mudpro	09-14	201-15-8268	18,00	-	-
1000 XT/TRV/Mudpro	08-14	201-15-8267	22,00	-	-
BOMBARDIER/CAN-AM					
Outlander 400 EFI	03-07	201-15-6053FR	33,50	201-14-0021	9,50
Outlander 400 Std./XT	2008	201-15-6053FR	33,50	201-14-0021	9,50
Outlander 400 EFI Std./XT	08-09	201-15-6059FR	33,50	201-14-0021	9,50
Outlander 400	08-14	201-15-6059FR	33,50	201-14-0021	9,50
DS 450	08-14	201-15-6049FR	33,50	-	-
DS 450 XC/MX	09-14	201-15-6049FR	33,50	-	-
Renegade 500	08-12	201-15-6052FR	33,50	201-14-0021	9,50
Renegade 500	13-14	201-15-6061P	79,00	-	-
Dry Replacement filter		201-15-6061FR	23,00	-	-
Outlander 500	07-12	201-15-6052FR	33,50	201-14-0021	9,50
Outlander 650	07-09	201-15-6052FR	33,50	201-14-0021	9,50
Outlander 650	10-12	201-15-6058P	57,00	201-14-0021	9,50
Dry Replacement filter		201-15-6058FR	33,50	-	-
Outlander 500/650	13-14	201-15-6061P	79,00	-	-
Dry Replacement filter		201-15-6061FR	23,00	-	-
Outlander 800	06-08	201-15-6052FR	33,50	201-14-0021	9,50
Renegade 800	07-08	201-15-6052FR	33,50	201-14-0021	9,50
Outlander 800 Max EFI	09-12	201-15-6058P	57,00	201-14-0021	9,50
Outlander 800R EFI	09-11	201-15-6058P	57,00	201-14-0021	9,50
Outlander X mr 800R	2012	201-15-6058P	57,00	201-14-0021	9,50
Renegade 800R	09-11	201-15-6058P	57,00	201-14-0021	9,50
Dry Replacement filter		201-15-6058FR	33,50	-	-
Outlander / Renegade 800R/1000R	12-14	201-15-6061P	79,00	-	-

Malli	Vm	Ilmansuodatin	Hinta	Öljynsuodatin	Osh.
BOMBARDIER/CAN-AM					
Dry Replacement filter		201-15-6061FR	23,00	-	-
HONDA					
250 TRX	86-89	201-15-0902	33,50	-	-
300 TRX	88-91	201-15-0910	33,50	201-14-0002	5,50
300 TRX	95-00	201-15-0910	33,50	201-14-0002	5,50
350 Rancher/ES	00-06	201-15-0912	33,50	201-14-0002	5,50
350 TRX	86-90	201-15-0911	33,50	201-14-0002	5,50
400 EX/X	99-14	201-15-0920	33,50	201-14-0002	5,50
400 TRX	99-14	201-15-0920	33,50	201-14-0002	5,50
400 Foreman	98-04	201-15-0910	33,50	201-14-0002	5,50
400 Rancher/4WD	04-07	201-15-0912	33,50	201-14-0000	5,50
420 Rancher	07-14	201-15-0914	33,50	201-14-0002	5,50
450 Foreman S/ES	98-06	201-15-0910	33,50	201-14-0002	5,50
450 TRX	04-05	201-15-0926	33,50	201-14-0003	6,50
450 TRX	06-14	201-15-0928P	62,00	201-14-0003	6,50
450 TRX replacement (must have 150928p first)	06-14	201-15-0928FR	36,00	-	-
500 Rubicon/Foreman	01-04	201-15-0925	33,50	201-14-0000	5,50
500 Rubicon/Foreman	05-14	201-15-0924	33,50	201-14-0000	5,50
650/675 Rincon	03-14	201-15-0924	33,50	201-14-0000	5,50
700 TRX	08-09	201-15-0931	33,50	-	-
KAWASAKI					
220 Bayou	88-02	201-15-1606	22,00	201-14-0004	5,50
250 Bayou	03-12	201-15-1606	22,00	201-14-0004	5,50
250 Mojave	87-04	201-15-1605	11,00	201-14-0004	5,50
300 Lakota Sport	95-04	201-15-1605	11,00	201-14-0004	5,50
300 Brute Force	12-14	201-15-1606	22,00	201-14-0004	5,50
360 Prairie	02-13	201-15-1912	22,00	201-14-0015	9,50
400 KFX	03-06	201-15-1801	22,00	201-14-0007	5,50
450 KFX	07-14	201-15-1802	24,00	201-14-0001	5,50
650 Prairie	2002	201-15-1911	11,00	201-14-0015	9,50
650 Prairie	2003	201-15-1913	22,00	201-14-0015	9,50
650 Brute Force 4X4	05-13	201-15-1913	22,00	201-14-0015	9,50
650 Brute Force 4X4i	06-13	201-15-1390	22,00	201-14-0015	9,50
700 KFX V-Force	04-09	201-15-1913	22,00	201-14-0015	9,50
700 Prairie	04-06	201-15-1913	22,00	201-14-0015	9,50
750 Brute Force	05-07	201-15-1390	22,00	201-14-0015	9,50



Malli	Vm	Ilmansuodatin	Hinta	Öljynsuodatin	Osh.
750 Brute Force/4x4i	08-14	201-15-1390	22,00	201-14-0015	9,50
KTM					
450 SX	08-09	201-15-4113	21,00		
450 SX	10-11	201-15-4114	21,00		
450 XC	08-09	201-15-4113	21,00	(1st) 201-14-0013	6,00
				(2nd) 201-14-0014	6,00
450 XC	10-11	201-15-4114	21,00	(1st) 201-14-0013	6,00
				(2nd) 201-14-0014	6,00
505 SX	2009	201-15-4113	21,00		
505 SX	10-13	201-15-4114	21,00		
525 XC	08-09	201-15-4113	21,00	(1st) 201-14-0013	6,00
				(2nd) 201-14-0014	6,00
525 XC	10-13	201-15-4114	21,00	(1st) 201-14-0013	6,00
				(2nd) 201-14-0014	6,00
POLARIS					
50 Scrambler/Predator/Outlaw	01-14	201-15-6080	11,00	-	
90 Sportsman/Predator/Outlaw	01-14	201-15-6080	11,00	-	
200 Phoenix	06-14	201-15-6083FR	43,00	-	
250 Trailblazer	01-07	201-15-6083FR	43,00	-	
300 Hawkeye/Sportsman	05-09	201-15-6083FR	43,00	-	
325	00-03	201-15-6140	33,50	-	
330 Magnum/4WD	03-05	201-15-6140	33,50	201-14-0016	9,50
330 Trail Boss/Trailblazer	03-13	201-15-6140	33,50	201-14-0016	9,50
335	98-00	201-15-6140	33,50	-	
400 Sportsman	01-05	201-15-6140	33,50	201-14-0016	9,50
400 Sportsman/Hawkeye	08-14	201-15-6140	33,50	-	
425 Xpedition	00-03	201-15-6140	33,50	201-14-0016	9,50
450 Sportsman	06-07	201-15-6140	33,50	201-14-0016	9,50
450 Outlaw MXR	08-09	201-15-6144FR	40,00	-	
500 Diesel	99-01	201-15-6140	33,50	-	
500 Magnum	99-02	201-15-6140	33,50	201-14-0016	9,50
500 Predator	03-07	201-15-6141P	72,00	201-14-0001	5,50
Replacement filter - must buy 156141p first		201-15-6141FR	24,00		
500 Scrambler 4x4	98-12	201-15-6140	33,50	201-14-0016	9,50
500 Sportsman	96-12	201-15-6140	33,50	-	
500 Sportsman 6X6	00-12	201-15-6140	33,50	201-14-0016	9,50
500 Xplorer	1997	201-15-6140	33,50	201-14-0016	9,50
500 X2 EFI	06-07	201-15-6140	33,50	-	
500 Sportsman HO/ Touring	08-14	201-15-6140	33,50	201-14-0016	9,50
525 IRS Outlaw	06-11	201-15-6143	18,00	-	
525 S Outlaw	08-09	201-15-6144FR	40,00	201-14-0016	9,50
550 Sportsman STD/ EPS / Touring	10-14	201-15-6140	33,50		
550 X2 Sportsman	10-14	201-15-6140	33,50		
550 XP/EPS EFI	09-11	201-15-6148P	46,00	-	
Replacement filter - must buy 156148p first		201-15-6148FR	33,50		
700 Sportsman	02-07	201-15-6140	33,50	-	
700 X2 EFI	08-09	201-15-6140	33,50	-	
800 Sportsman	05-14	201-15-6140	33,50	-	
800 X2 EFI	06-07	201-15-6140	33,50	-	
800 X2 EFI	09-11	201-15-6140	33,50	-	
800 Touring	08-12	201-15-6140	33,50	-	
800 RZR/RZR 4 Ranger	09-14	201-15-6147P	46,00	-	
Replacement filter - must buy 156147p first		201-15-6147FR	33,50	-	

Malli	Vm	Ilmansuodatin	Hinta	Öljynsuodatin	Osh.
POLARIS					
800 4x4 Ranger	10-12	201-15-6146P	52,00	-	
Replacement filter - must buy 156146p first		201-15-6146FR	23,00		
850 Touring/EPS	09-14	201-15-6140	33,50	-	
850 Sportsman XP/ EPS EFI	09-14	201-15-6148P	46,00	-	
Replacement filter - must buy 156148p first		201-15-6148FR	33,50		
900 Ranger Diesel	11-12	201-15-6146P	52,00	-	
900 Ranger Diesel	2013	201-15-6147P	46,00	-	
Replacement filter - must buy 156147p first		201-15-6147FR	33,50	-	
SUZUKI					
90 LT-Z	07-14	201-15-3047	11,00	-	
160 Quadrunner	91-01	201-15-3905	22,00	201-14-0005	5,50
160 Quadrunner	03-05	201-15-3905	22,00	201-14-0005	5,50
250 Ozark	02-14	201-15-3048	22,00	201-14-0005	5,50
250 Quadracer	85-86	201-15-3900	22,00	-	
250 Quadracer	87-92	201-15-3901	22,00	-	
250 Quadrunner	88-01	201-15-3510	22,00	201-14-0005	5,50
250 Quadrunner 4WD	87-02	201-15-3510	22,00	201-14-0005	5,50
250 Quadsport LT-Z	04-11	201-15-3511	22,00	201-14-0005	5,50
300 King Quad	91-02	201-15-3510	22,00	201-14-0005	5,50
400 LT-Z	03-13	201-15-3908	22,00	201-14-0007	5,50
400 Eiger / 400 King Quad	02-14	201-15-3908	22,00	201-14-0006	9,50
LTR 450 Quadracer	06-11	201-15-3910	22,00	201-14-0007	5,50
450 King Quad	07-10	201-15-3915C	66,00	201-14-0006	9,50
Dry Replacement filter		201-15-3915FR	25,50	-	
500 Quadmaster	00-01	201-15-3907	22,00	-	
500 Quadrunner	98-02	201-15-3907	22,00	201-14-0006	9,50
500 Vinson (all)	02-07	201-15-3908	22,00	201-14-0006	9,50
500 King Quad	09-14	201-15-3915C	66,00	201-14-0006	9,50
Dry Replacement filter		201-15-3915FR	25,50	-	
700 Twin Peaks	04-05	201-15-1913	22,00	201-14-0015	9,50
700/750 King Quad	05-14	201-15-3915C	66,00	201-14-0006	9,50
Dry Replacement filter		201-15-3915FR	25,50	-	
YAMAHA					
125 Breeze	98-04	201-15-2906	22,00	-	
125 Grizzly/Raptor	05-14	201-15-2906	22,00	-	
200 Blaster	90-06	201-15-2906	22,00	-	
250 Raptor	08-14	201-15-2923	22,00	201-14-0017	6,50
300 Grizzly	12-13	201-15-2913	15,00	-	
350 Banshee	87-06	201-15-2900	22,00	-	
350 Big Bear 2/4WD	87-99	201-15-2610	22,00	201-14-0008	10,00
350 Warrior	87-04	201-15-2903	22,00	201-14-0008	10,00
350 Wolverine / 4WD	95-09	201-15-2903	22,00	201-14-0008	10,00
350 Raptor	04-14	201-15-2903	22,00	201-14-0008	10,00
400 Kodiak	96-99	201-15-2610	22,00	201-14-0008	10,00
400 Kodiak /4WD	00-02	201-15-2613	22,00	201-14-0016	9,50
450 YFZ	04-14	201-15-2902	24,00	201-14-0017	6,50
450 Rhino	06-09	201-15-2614	17,50	201-14-0016	9,50
YFZ 450 R	09-14	201-15-2902	24,00	201-14-0017	6,50
YFZ 450 X	10-14	201-15-2902	24,00	201-14-0017	6,50
550 Grizzly	09-14	201-15-2912	12,50	201-14-0015	9,50
600 Grizzly	98-01	201-15-2903	22,00	201-14-0010	5,50
660 Grizzly	02-09	201-15-2903	22,00	201-14-0011	9,50
660 Raptor	01-05	201-15-2904	22,00	201-14-0011	9,50
Rhino 660	05-07	201-15-2614	17,50	201-14-0016	
700 Raptor	06-14	201-15-2908	24,00	201-14-0010	
700 Grizzly	07-14	201-15-2912	12,50	201-14-0015	
700 Rhino	08-14	201-15-2924	24,00	201-14-0015	

FR = Flame Resistant (triple stage foam 15mm)

C = Air filter only for Powerflow Kits

P = Replacement for OEM air filter



Vanteet ja renkaat



Talvituet



Vinsit



Laukut ja tuulisuojat



Sähköosat



Jousitus ja voimansiirto



Pakoputket ja suutinsarjat



Ohjaus



Rungon osat ja peitteet



Jarrupalat ja rattaat



Moottori



Variaattorin osat



Maatalous-tarvikkeet



Kärryt ja reet



ATV



ATV



ILMANSUODATTIMET

Alkuperäistä vastaavat, laadukkaat ilmansuodattimet.

BRONCO

ATV COMPONENTS



Vanteet ja renkaat



Talvituet



Vinssit



Laukut ja tuulisuojat



Sähköosat



Jousitus ja voimansiirto



Pakoputket ja suutinsarjat



Ohjauk



Rungon osat ja peitteet



Jarrupalat ja rattaat



Moottori



Variaattorin osat



Maatalous-tarvikkeet



Kärryt ja reet



ATV



ATV



ATV



ATV



79-07064



79-07089



79-07262



79-07264



79-07284



79-07296



79-07298



79-07310



79-07312

ARCTIC CAT	VM	OEM	Tuotenro	Hinta
500 Kaikki	2009-10	0470-558	79-07310	15,50
550 Kaikki	2009-14	0470-558	79-07310	15,50
650 H1	2008	0470-558	79-07310	15,50
700 Kaikki	2009-12	0470-558	79-07310	15,50
MUDPRO 650 H1	2010	0470-558	79-07310	15,50
PROWLER 550	2009-14	0470-558	79-07310	15,50
PROWLER 650	2009-13	0470-558	79-07310	15,50
PROWLER 700	2009-14	0470-558	79-07310	15,50
PROWLER 1000	2009-13	0470-558	79-07310	15,50

CAN-AM	VM	OEM	Tuotenro	Hinta
330 OUTLANDER	2004-05		79-07284	23,20
400 OUTLANDER	2003-07		79-07284	23,20
400 OUTLANDER EFI	2008-14		79-07296	24,00
500 OUTLANDER	2007-12		79-07283	29,30
500 OUTLANDER	2013-14		79-07298	30,00
500 RENEGADE	2008-12		79-07283	29,30
650 OUTLANDER	2006-10		79-07283	29,30
650 OUTLANDER	2013-14		79-07298	30,00
800 OUTLANDER	2006-10		79-07283	29,30
800 OUTLANDER R	2013-14		79-07298	30,00
800 RENEGADE EFI	2007-10		79-07283	29,30
1000 OUTLANDER	2013-14		79-07298	30,00

HONDA	VM	OEM	Tuotenro	Hinta
TRX 300	1988-01	17254-HC5-900	79-07026	19,20
TRX 400 EX	2000-12	17254-HN1-000	79-07064	24,20
TRX 400 FOUR TRAX	1992-04	17254-HC5-900	79-07026	19,20
TRX 400 FOREMAN	1998-03	17254-HC5-900	79-07026	19,20
TRX 420	2007-14	17254-HP5-600	79-07089	24,20
TRX 420	2015-	17254-HN1-000	79-07064	24,20
TRX 500FA RUBICON/ GPSCAPE	2000-15	17254-HN1-000	79-07064	24,20
TRX 500 ES/PS	2005-08	17254-HN1-000	79-07064	24,20
TRX 600 RINCON	2003-04	17254-HN1-000	79-07064	24,20
TRX650FA RINCON/ GPSCAPE	2003-05	17254-HN1-000	79-07064	24,20

KAWASAKI	VM	OEM	Tuotenro	Hinta
KVF650 BRUTE FORCE 4X4	2003-10	11013-0001	79-07262	20,20
KVF650 BRUTE FORCE 4X4	2011-14	11013-0007	79-07263	20,20
KVF650/700 PRAIRIE 4X4	2003-06	11013-0001	79-07262	20,20
KSV700 KFX	2004-09	11013-0001	79-07262	20,20
KVF750 BRUTE FORCE	2005-14	11013-0007	79-07263	20,20

POLARIS	VM	OEM	Tuotenro	Hinta
200 SAWTOOTH	2006-07	452306/ 1253355	79-07264	24,20
200 PHOENIX	2005-12	452306/ 1253355	79-07264	24,20
250 TRAIL BLAZER	2001-06	452306/ 1253355	79-07264	24,20
250 XPLOER	2001-02	452306/ 1253355	79-07264	24,20
300 HAWKEYE	2006-07	452306/ 1253355	79-07264	24,20
300 HAWKEYE	2010	452306/ 1253355	79-07264	24,20
300 SPORTSMAN	2008-10	452306/ 1253355	79-07264	24,20
325 EXPEDITION	2000-02	7080595/1253114	79-07043	24,20
325 MAGNUM	2001-02	1253372	79-07265	24,20
325 TRAILBOSS	2000-01	7080595/1253114	79-07043	24,20
330 ATP	2004-04	1253372	79-07265	24,20
330 MAGNUM	2003-06	1253372	79-07265	24,20
330 TRAILBOSS	2001-09	1253372	79-07265	24,20
330 TRAILBOSS	2010-12	7080595/1253114	79-07043	24,20
330 TRAIL BLAZER	2008-09	1253372	79-07265	24,20
335 SPORTSMAN	1999-01	7080595/1253114	79-07043	24,20
400 SCRAMBLER 2X4, 4X4	1995-02	1253118	79-07007	20,20
400 SPORT	1996-99	1253118	79-07007	20,20
400 SPORTSMAN 4X4	2001-12	7080595/1253114	79-07043	24,20

POLARIS	VM	OEM	Tuotenro	Hinta
400 SPORTSMAN H.O	2001-14	7080595/1253114	79-07043	24,20
400 TRAIL BLAZER	2003	1253118	79-07007	20,20
400 XPLOER 4X4	1999-00	1253118	79-07007	20,20
400 XPLOER 4X4	2001-02	452306/ 1253355	79-07264	24,20
400 XPRESS 2X4	1996-97	1253118	79-07007	20,20
425 MAGNUM 2X4,4X4,6X6	1995-98	1253118	79-07007	20,20
425 XPEDITION 4X4	2000-02	7080595/1253114	79-07043	24,20
450 SPORTSMAN	2006-07	7080595/1253114	79-07043	24,20
455 DIESEL 4X4	1999-01	7080595/1253114	79-07043	24,20
500 ATP ,HO	2004-05	7080595/1253114	79-07043	24,20
500 BIG BOSS 6X6	1998-99	1253118	79-07007	20,20
500 MAGNUM 4X4	1999-03	7080595/1253114	79-07043	24,20
500 RANGER	2006-12	7081308	79-07293	34,20
500 SCRAMBLER 2X4	2001-02	7080595/1253114	79-07043	24,20
500 SPORTSMAN H.O.	1996-12	7080595/1253114	79-07043	24,20
500 SPORTSMAN X2	2006-07	7080595/1253114	79-07043	24,20
500 WORKER	1999	7080595/1253114	79-07043	24,20
500 XPOLER 4X4	1997	7080595/1253114	79-07043	24,20
550 SPORTSMAN XP	2009-14	7080595/1253114	79-07043	24,20
570 SPORTSMAN	2014-	7080595/1253114	79-07043	24,20
600 SPORTSMAN 4X4/ TWIN	2003-05	7080595/1253114	79-07043	24,20
700 RANGER	2006-09	7081308	79-07293	34,20
700 SPORTSMAN TWIN/ FI/MV	2003-10	7080595/1253114	79-07043	24,20
800 RANGER	2010	7081308	79-07293	34,20
800 RANGER	2011-14	1240482	79-07312	24,20
800 RZR	2008-14	1240482	79-07312	24,20
800 SPORTSMAN/EFI/ HO/TOURING	2006-12	7080595/1253114	79-07043	24,20
800 SPORTSMAN X2 EFI	2007-14	7080595/1253114	79-07043	24,20
850 SPORTSMAN XP	2009-14	7080595/1253114	79-07043	24,20
850 SCRAMBLER	2014-	7080595/1253114	79-07043	24,20
900 RANGER DIESEL	2012-14	1240482	79-07312	24,20
1000 SCRAMBLER	2014-	7080595/1253114	79-07043	24,20

SUZUKI	VM	OEM	Tuotenro	Hinta
LTA400/F EIGER AUTO 2X4	2002-07	13780-03G00	79-07270	20,20
LTA400/F EIGER AUTO 4X4/CAMO	2002-07	13780-03G00	79-07270	20,20
LTA400 KING QUAD	2008-12	13780-03G00	79-07270	20,20
LTZ-400 QUADSPORT	2003-09	13780-03G00	79-07270	20,20
LT-A450X KINGQUAD/ AXI	2007-11	13780-31G00	79-07272	28,30
LT-A700X KING QUAD	2005-07	13780-31G00	79-07272	28,30
LTA750X KING QUAD AXI	2008-12	13780-31G00	79-07272	28,30

YAMAHA	VM	OEM	Tuotenro	Hinta
YFM350FAS BRUIN 2X4, 4X4	2004-06	5UH-E4451-10-00	79-07276	24,20
YFM350FX WOLVERINE	2006-09	5UH-E4451-10-00	79-07276	24,20
YFM350 GRIZZLY	2007-11	5UH-E4451-10-00	79-07276	24,20
YFM400 KODIAK 2X4, 4X4	2005-06	5UH-E4451-10-00	79-07276	24,20
YFM400FX WOLVERINE 4X4	2005-06	5UH-E4451-10-00	79-07276	24,20
YFM400 GRIZZLY AUTO 4X4	2007-08	5UH-E4451-10-00	79-07276	24,20
YFM450 GRIZZLY AUTO 4X4	2007-12	5UH-E4451-10-00	79-07276	24,20
YFM450 KODIAK 4X4	2005-06	5UH-E4451-10-00	79-07276	24,20
YFM450FX WOLVERINE	2007-10	5UH-E4451-10-00	79-07276	24,20
550 GRIZZLY	2009-11	3B4-14451-00	79-07159	16,20
700 GRIZZLY	2007-11	3B4-14451-00	79-07159	16,20



ILMAN- JA ÖLJYNSUODATTIMET



ÖLJYNSUODATTIMET

Yliittävät O.E.M.normit. Peltisuodattimissa 17mm mutterikanta helpottaa irrottamista, sis. myös rei'ät varmistuslankaa varten.

K&N käyttää resiinillä kyllästettyä selluloosapohjaista suodatinmateriaalia, mikä mahdollistaa korkeamman virtauksen antaen samalla yliivoimainen virtauksen. Heavy-duty anti-drain back venttili.

ARTIC CAT		K&n ilmasuodatin	OSH	K&N ÖLJY-SUODATIN	OSH
250	99-05	20-AC3098	70	20-KN132	7,50
300	98-05	20-AC3098	70	20-KN132	7,50
400	98-02	20-AC4096-1	65	20-KN138	15,00
400 4x4	01-05	20-AC4096-1	65	20-KN138	15,00
400 4x4	06-08	20-AC4004	82	20-KN138	15,00
400 DVX	04-08	20-SU4002	87	20-KN139	7,50
454	96-98	20-AC4096-1	65	20-KN138	15,00
500	00-02	20-AC4096-1	65	20-KN138	
500 4x4	05-08	20-AC4004	82	20-KN138	15,00
500 4x4	09-10	20-AC4004	82	20-KN621	14,00
550	09-14	20-AC7009	69	20-KN621	14,00
650 V2	05-06	20-AC6504	65	20-KN204	15,50
650 4x4	04	20-AC6504	65	20-KN204	15,50
650 4x4 H1	05	20-AC4004	82	20-KN138	15,00
650 4x4 H1	07-11	20-AC4004	82	20-KN138	15,00
700	10-14	20-AC7009	69	20-KN621	14,00
1000 (Ei Wildcat)	09-14	20-AC1009	79	20-KN621	14,00
BOMBARDIER/CAN-AM		K&N ILMA-SUODATIN	OSH	K&N ÖLJY-SUODATIN	OSH
330 Outlander	03-06	20-BD3303	652	20-KN152	15,50
400 Outlander	03-08	20-BD3303	62	20-KN152	15,50
400 Outlander EFI	09-14			20-KN152	15,50
DS450/X	08-14	20-CM4508	87	20-KN560	10,00
500 Outlander EFI	07-12	20-BD6506	72	20-KN152	15,50
500 Outlander EFI	13-14	20-CM8012	64	20-KN152	15,50
500 Traxter	01-05	20-BD6502	82	20-KN557	14,00
500 Traxter Auto CVT	05	20-BD6502	82	20-KN556	13,50
DS650	00-07	20-BD6500	75	20-KN152	15,50
650 Quest	02-04	20-BD6500	75	20-KN556	13,50
650 Traxter 650 Auto CVT	05	20-BD6500	75	20-KN556	13,50
650 Outlander	06-09	20-BD6506	72	20-KN152	15,50
650 Outlander	10-12	20-CM8009	69	20-KN152	15,50
650 Outlander EFI	13-14	20-CM8012	64	20-KN152	15,50
800 Commander R	11-14	20-CM8011	72	20-KN152	15,50
800 Outlander	07-08	20-BD6506	72	20-KN152	15,50
800 Outlander	09-11	20-CM8009	69	20-KN152	15,50
800 Outlander	12-14	20-CM8012	64	20-KN152	15,50
800 Renegade	07-08	20-BD6506	72	20-KN152	15,50
800 Renegade	09-11	20-CM8009	99	20-KN152	15,50
800 Renegade	12-14	20-CM8012	64	20-KN152	15,50
1000 Maverick	13-14	20-CM8011	72	20-KN152	15,50
1000 Commander	11-14	20-CM8011	72	20-KN152	15,50
1000 Outlander	12	20-CM8012	64	20-KN152	15,50
1000 Renegade	12-14	20-CM8012	64	20-KN152	15,50

ILMANSUODATTIMET

"K&N X-Stream" on suodatin omassa luokassaan. X-Stream suodatin toimii vielä pitkään sen jälkeen kuin tavallinen vahtomuovi- tai paperisuodatin olisi aivan tukossa, koska sen kokonaispinta-ala on monta kertaa suurempi kuin normisuodatin. Tänä vuonna vielä parannettu syvemmällä poimuilla ja "tupla-huuli" -tiivistyspinnalla.

HONDA		K&N ILMA-SUODATIN	OSH	K&N ÖLJY-SUODATIN	OSH
TRX250	01-09	20-HA2501	72		
TRX300 EX	93-09	20-HA3094	53,00	20-KN113	7,50
TRX350 TE / FM / FE / EX	86-06	20-HA3500	72	20-KN113	7,50
TRX400 X/EX	99-09	20-HA4099	65	20-KN113	7,50
TRX400 X	12-14	20-HA4099	65	20-KN113	7,50
TRX420 FE / FM / TE / TM	07-14	20-HA4207	75	20-KN113	7,50
TRX420 FA RANCHER	09-14	20-HA4207	75	20-KN114	8,00
TRX450 FM / FE Foreman	98-04	20-HA3098	72	20-KN113	7,50
TRX450 R	04-05	20-HA4504	95	20-KN116	7,50
TRX450 R	06-14	20-BD6500	75	20-KN116	7,50
TRX500 Foreman4x4	05-14	20-HA5000	82	20-KN113	7,50
TRX500 FA Foreman Rubicon	01-11	20-HA5000	82	20-KN111	8,00
TRX500 FA Foreman Rubicon	12-14	20-HA6806	76	20-KN111	8,00
TRX650 FA / FGA Rincon	03-05	20-HA5000	82	20-KN111	8,00
TRX680 FA / FGA Rincon	06-14	20-HA6806	76	20-KN111	8,00
TRX700XX	08-09	20-HA6808	99	20-KN112	7,50
KAWASAKI		K&N ILMA-SUODATIN	65	K&N ÖLJY-SUODATIN	OSH
KLF300 Bayou	89-04	20-KA4093	68	20-KN123	8,50
KVF300 Prairie	99-02	20-KA4093	68	20-KN303	15,50
KVF360 Prairie	03-14	20-KA3603	66	20-KN204	15,50
KFX400	03-06	20-SU4002	87	20-KN139	7,50
KLF400 Bayou	93-99	20-KA4093	68	20-KN303	15,50
KVF400 Prairie	99-02	20-KA4093	68	20-KN303	15,50
KFX450R	08-14	20-KA4508	99	20-KN112	7,50
KVF650 Prairie / Brute Force	03-13	20-KA6503	85	20-KN204	15,50
KFX700	04-09	20-KA6503	85	20-KN204	15,50
KFX700	10-11	20-KA6503	85		
KVF700 Prairie	04-06	20-KA6503	85	20-KN204	15,50
KVF750 Brute Force	05-07	20-KA7504	95	20-KN204	15,50
KVF750 Brute Force	08-14	20-KA7408	87	20-KN204	15,50
POLARIS		K&N ILMA-SUODATIN	OSH	K&N ÖLJY-SUODATIN	OSH
250 Trailblazer	91-00	20-PL1001	61		
250 Trailblazer	01-06	20-PL1004	65		
250 Xplorer	00	20-PL1001	61		
250 Xplorer	01-02	20-PL1004	65		
325 Magnum	00-02	20-PL1003	61	20-KN303	15,50
325 Trail Boss	01-02	20-PL1003	61	20-KN303	15,50
325 Xpedition	00-02	20-PL1003	61	20-KN303	15,50
330 Magnum	03-06	20-PL1005	68	20-KN303	15,50

Pakoputket ja suutinsarjat

Ohjauk

Rungon osat ja peitteet

Jarrupalat ja rattaat

Moottori

Variaattorin osat

Maatalous-tarvikkeet

Kärryt ja reet



ILMAN- JA ÖLJYSUODATTIMET JATKUU



Vanteet ja renkaat



Talvituotteet



Vinssit



Laukut ja tuulisuojat



Sähköosat



Jousitus ja voimansiirto



Pakoputket ja suutinsarjat



Ohjauk



Rungon osat ja peitteet



Jarrupalat ja rattaat



Moottori



Variaattorin osat



Maatalous-tarvikkeet



Kärryt ja reet

POLARIS		K&N ILMA-SUODATIN	OSH	K&N ÖLJYSUODATIN	OSH
330 Trail Boss	03-09	20-PL1005	68	20-KN303	15,50
330 Trail Boss	10-13	20-PL1003	61	20-KN303	15,50
335 Sportsman	99-01	20-PL1003	61	20-KN303	15,50
400 Sport	96-99	20-PL1002	58		
400 Scrambler	96-02	20-PL1002	58		
400 Sportsman	01-12	20-PL1003	61	20-KN303	15,50
400L Xplorer	96-98	20-PL1001	61	20-KN303	15,50
	99-00	20-PL1002	58	20-KN303	15,50
	01-	20-PL1004	65	20-KN303	15,50
400/455 RANGER	10-14	20-PL5008	88	20-KN303	15,50
425 Magnum	95-98	20-PL1002	58	20-KN303	15,50
425 Xpedition	00-02	20-PL1003	61	20-KN303	15,50
450 Sportsman	08-14	20-PL1003	61	20-KN303	15,50
450 Outlaw MXR	08-09			20-KN155/157	
455 Diesel	99-01	20-PL1003	61	20-KN303	15,50
500 ATP HO	04-05	20-PL1003	61	20-KN303	15,50
500 Big Boss	98-99	20-PL1002	58	20-KN303	15,50
500 Magnum	99-02	20-PL1003	61	20-KN303	15,50
500 Outlaw	06-07	20-PL5006	79	20-KN112	7,50
500 Predator	03-07	20-PL5003	68,00	20-KN112	7,50
500 Ranger	06-09	20-PL5008	88	20-KN303	15,50
500 Ranger	10-13	20-PL5008	88		
500 Scrambler	96-12	20-PL1003	61	20-KN303	15,50
500 Sportsman	00-13	20-PL1003	61	20-KN303	15,50
500 Xplorer 4x4	97	20-PL1003	61	20-KN303	15,50
550 Sportsman	10-14	20-PL1103	61		
550 Sportsman XP	09-12	20-PL5509	75		
570 Ranger RZR	12-14	20-PL5712	63	20-KN198	15,50
600 Sportsman	03-05	20-PL1003	61	20-KN196	14,00
700 Sportsman Twin	02-03	20-PL1003	61	20-KN196	14,00
700 Sportsman Twin	05-07	20-PL1003	61	20-KN198	15,50
700 MVSR	08	20-PL5008	85,60		
700 Ranger 6x6 EFI, HD, Crew	06-09	20-PL5008	85,60	20-KN198	15,50
760 Ranger	10	20-PL5008	85,60	20-KN198	15,50
760 Ranger	11-14	20-PL8007	82	20-KN198	15,50
800 Ranger	11-14	20-PL8007	82	20-KN198	15,50
800 Sportsman	05-14	20-PL1003	61	20-KN198	15,50
850 Sportsman XP	10-14	20-PL5509	75		
900 Ranger RZR	11-13	20-PL9011	75	20-KN198	15,50
900 Ranger XP	13-14	20-PL5712	63	20-KN198	15,50

SUZUKI		K&N ILMA-SUODATIN	OSH	K&N ÖLJY-SUODATIN	OSH
LT-Z90 QuadSport	07-09			20-KN131	7,50
LT-F250	88-07	20-SU2588	60	20-KN132	7,50
LT-F 250 OZARK	02-09	20-SU2504	85,00		
LT-Z250 QuadSport	04-09	20-SU2504	85,00	20-KN132	7,50
LT-F300F King Quad	91-02	20-SU2588	60	20-KN132	7,50
LT-F400F Eiger	02-07	20-SU5002	93	20-KN138	15,00
LT-A400 F / FC Eiger	02-07	20-SU5002	93	20-KN138	15,00

SUZUKI		K&N ILMA-SUODATIN	OSH	K&N ÖLJY-SUODATIN	OSH
LT-F 400 Kingquad	12-14	20-SU5002	93	20-KN138	15,00
LT-Z400 QuadSport	03-09	20-SU4002	87	20-KN139	7,50
LT-A450X King Quad	07-10	20-SU7005	78	20-KN138	15,00
LT-R450 Quadracer	06-09	20-SU4506	88	20-KN139	7,50
LT-F500F Quadrunner	98-02	20-SU5098	85	20-KN138	15,00
LT-A500F Vinson	03-07	20-SU5002	93	20-KN138	15,00
LTA700 King Quad	05-07	20-SU7005	78	20-KN138	15,00
LTV700 Twin Peaks	04-05	20-KA6503	85	20-KN204	15,50
LTA750X Kingquad	08-13	20-SU7005	78	20-KN138	15,00

YAMAHA		K&N ILMA-SUODATIN	OSH	K&N ÖLJY-SUODATIN	OSH
YFB230 Timberwolf	92-00	20-YA2597	60	20-KN143	11,00
YFB250 FW Timberwolf	94-00	20-YA2597	60	20-KN143	11,00
YFM250 Raptor	08-13	20-YA2088	63	20-KN140	8,50
350 Banshee	87-05	20-YA3502	65		
YFM350 Warrior	87-04	20-YA4350	71	20-KN142	10,50
YFM350 Big Bear	87-99	20-YA2597	60	20-KN142	10,50
YFM350 Bruin	04-06	20-YA3504	81	20-KN303	15,50
YFM350 Wolverine 4x4	94-05	20-YA4350	71	20-KN142	10,50
YFM350 Wolverine 2 WD	06-09	20-YA3504	81	20-KN204	15,50
YFM350 Raptor	04-13	20-YA6602	88	20-KN142	10,50
YFM350 GRIZZLY	10-14	20-YA3504	81	20-KN204	15,50
YFM400 Kodiak	94-99	20-YA2597	60	20-KN142	10,50
YFM400 Kodiak	00-02	20-YA4000	75	20-KN303	15,50
YFM400 Kodiak	03	20-YA4003	81	20-KN303	15,50
YFM400 Kodiak	04-06	20-YA3504	81	20-KN303	15,50
YFM400 Big Bear	00-06	20-YA4001	68	20-KN142	10,50
YFM400 Grizzly	07-08	20-YA3504	81	20-KN204	15,50
YFM450 Kodiak	03-04	20-YA4003	81	20-KN303	15,50
YFM450 Kodiak	05-06	20-YA3504	81	20-KN303	15,50
YFM450 Wolverine	06-12	20-YA3504	81	20-KN303	15,50
YFM450 Grizzly	07-14	20-YA3504	81	20-KN303	15,50
YFZ450	04-06	20-YA4504	89	20-KN141	9,50
YFZ450, R	07-14	20-YA4504	89	20-KN140	8,50
YFM550 Grizzly	09-14	20-YA7007	88	20-KN204	15,50
YFM600 Grizzly	98-01	20-YA4350	71	20-KN145	8,00
YFM660 Grizzly	02-06	20-YA6602	87	20-KN303	15,50
YFM660 Grizzly	07-08	20-YA6602	87	20-KN204	15,50
YFM660 Raptor	01-05	20-YA6601	86	20-KN147	15,50
YXR660 Rhino	04-07	20-YA6504	69	20-KN303	15,50
YFM700 Grizzly	07-14	20-YA7007	88	20-KN204	15,50
YFM700 Raptor	06-14	20-YA7006	149	20-KN145	8,00
YXR700 Rhino	08-13	20-YA7008	72	20-KN204	15,50

* HUOM! Erikoissuodatin, vaatii muutoksia suodatinkoteloon.

ÖLJYT JA PUHDISTUSAINEET



Huoltopakkaus

Sisältää öljyä ja puhdistusainetta

Tuotenumero	Hinta
20-99-5050	20,00



Suodatinöljy 250ml

Tuotenumero	Hinta
20-99-0533	8,60



Suodattimen puhdistusaine

0,946 litraa (sis. pumpun)

Tuotenumero	Hinta
20-99-0621	18,20



Suodattimen puhdistusaine

täyttöpakkaus, 3,78 litraa.

Tuotenumero	Hinta
20-99-0635	42,90

ATV



ÖLJYNSUODATTIMET

HIFLO:n öljynsuodattimet ovat mitoiltaan ja suodatusominaisuuksiltaan alkuperäissuodattimen veroisia ja niissä käytetään parhaita saatavilla olevia materiaaleja. Käyttämällä HIFLO- suodatinta voit olla varma voiteluöljyn toiminnasta koko sen käyttöajan. TUV- hyväksytyt!



ARTIC CAT			
Malli	Vm.	Tuoteno.	Hinta
250	99-05	20-HF132	3,80
300	98-05	20-HF132	3,80
366	09-11	20-HF621	11,20
400	98-08	20-HF138	9,40
400 DVX	04-08	20-HF139	4,60
425 CR	11-12	20-HF621	11,20
450	10-13	20-HF621	11,20
454	96-98	20-HF138	9,40
500 4X4	98-08	20-HF138	9,40
500 AUTOMATIC	04-07	20-HF138	9,40
500 AUTOMATIC,4x4	08-09	20-HF621	11,20
500 / 550 CORE	13-14	20-HF621	11,20
550 H1, Prowler, TRV , i	09-12	20-HF621	11,20
550 LTD / XT / TRV	13-14	20-HF621	11,20
600	04	20-HF204	9,40
650 H1	06-09	20-HF621	11,20
650 V-2	04-06	20-HF204	9,40
700 (ei diesel)	07-14	20-HF621	11,20
1000	08-13	20-HF621	11,20

CAN AM (BOMBARDIER)			
Malli	Vm.	Tuoteno.	Hinta
200 Rally	03-07	20-HF559	5,20
330 Outlander	04-05	20-HF152	9,20
400 Outlander, EFI	04-14	20-HF152	9,20
450 DS	08-12	20-HF560	5,60
500 Outlander EFI	07-14	20-HF152	9,20
500 Renegade EFI	08-14	20-HF152	9,20
500 Traxter	99-05	20-HF557	10,20
500 Traxter Auto CVT	05	20-HF556	8,60
500 Traxter Max 5 Speed Auto-Shift	05	20-HF557	10,20
500 Quest	03-04	20-HF556	8,60
DS650	00	20-HF151	7,20
DS650	01-06	20-HF152	9,20
650 Outlander EFI	07-14	20-HF152	9,20
650 Quest	02-04	20-HF556	8,60
650 Traxter 650 Auto CVT	05	20-HF556	8,60
800 Outlander	06-14	20-HF152	9,20
800 Renegade	08-14	20-HF152	9,20
990 Spyder	08-12	20-HF564	10,00
990 Spyder (vaiht.suod.)	09-12	20-HF559	5,20
1000 SSV Commander	11-12	20-HF152	9,20
1000 Ourlander	12-13	20-HF152	9,20

CF MOTO			
Malli	Vm.	Tuoteno.	Hinta
CF500, CF118		20-HF682	9,40

GAS GAS			
Malli	Vm.	Tuoteno.	Hinta
450 Wild HP	04-	20-HF112	4,00

GOES			
Malli	Vm.	Tuoteno.	Hinta
450 X		20-HF682	9,40
520		20-HF682	9,40
625		20-HF682	9,40

GILERA			
Malli	Vm.	Tuoteno.	Hinta
250 Oregon	07-08	20-HF183	5,80

HONDA			
Malli	Vm.	Tuoteno.	Hinta
TRX200 D	90-97	20-HF112/20-HF113	4,00/4,00
TRX250	85-87	20-HF112/20-HF113	4,00/4,00
TRX250 FOURTRAX	88-92	20-HF112/20-HF113	4,00/4,00
TRX250	01-07	20-HF112/20-HF113	4,00/4,00
TRX300 FOURTRAX	87-97	20-HF112/20-HF113	4,00/4,00
TRX300 FOURTRAX	98-01	20-HF112/20-HF113	4,00/4,00
TRX300 EX	93-05	20-HF112/20-HF113	4,00/4,00
TRX300 SPORTRAX	03-08	20-HF112/20-HF113	4,00/4,00
TRX300 X-9	09	20-HF112/20-HF113	4,00/4,00
TRX350 TE / FM / FE / EX	86-06	20-HF113	4,00
TRX400 FW Foreman	95-97	20-HF113	4,00
TRX400 FW Foreman	98-03	20-HF113	4,00
TRX400 EX / Sportrax	99-08	20-HF113	4,00
TRX400 FA / FGA Rancher	04-07	20-HF111	5,20
TRX400 X-9	09	20-HF112/20-HF113	4,00/4,00
TRX420 FE / FM / TE / TM	07-14	20-HF113	4,00
TRX420 FA/FPA Rancher	09-14	20-HF114	7,20
TRX450 FM / FE Foreman	98-04	20-HF113	4,00
TRX450 R	04-12	20-HF116	4,60
TRX500 FA Foreman Rubicon	00-14	20-HF111	5,20
TRX500 FE / FM / TM Foreman	05-13	20-HF113	4,00
TRX500 FGA Foreman Rubicon	04-08	20-HF111	5,20
TRX500 FPA / FPE / FPM	07-13	20-HF113	4,00
TRX650 FA / FGA Rincon	03-05	20-HF111	5,20
TRX680 FA / FGA Rincon	06-14	20-HF111	5,20
TRX700 XX	08-09	20-HF112	4,00

HYUOSUNG			
Malli	Vm.	Tuoteno.	Hinta
TE450	08-11	20-HF682	9,40

JOHN DEERE			
Malli	Vm.	Tuoteno.	Hinta
500 Buck	05	20-HF557	10,20
650 Trail Buck	05	20-HF556	8,60

KAWASAKI			
Malli	Vm.	Tuoteno.	Hinta
KLF220 Bayou	88-02	20-HF123	4,80
KLF250 Bayou	03-12	20-HF123	4,80
KSF250 Mojave	87-04	20-HF123	4,80
KAF300 Mule 550,520		20-HF128	9,80
KEF300 Lakota	95-03	20-HF123	4,80
KLF300 Bayou	86-04	20-HF123	4,80
KVF300 Prairie	99-02	20-HF303	9,40
KVF360 Prairie	03-12	20-HF204	9,40
KFX400	05-06	20-HF139	4,60
KLF400 Bayou	93-98	20-HF303	9,40
KVF400 Prairie	97-02	20-HF303	9,40
KAF400 Mule 600,610	05-12	20-HF128	9,80
KAF450 Mule		20-HF303	9,40
KFX450 R	08-14	20-HF112	4,00
KAF620 Mule		20-HF128	9,80
KVF650 Prairie / Brute Force	02-13	20-HF204	9,40
KFX700	04-09	20-HF204	9,40



Vanteet ja renkaat



Talvituotteet



Vinsit



Laukut ja tuulisuojat



Sähköosat



Jousitus ja voimansiirto



Pakoputket ja suutinsarjat



Ohjaus



Rungon osat ja peitteet



Jarrupalat ja rattaat



Moottori



Variaattorin osat



Maatalous-tarvikkeet



Kärryt ja reet

ATV





ÖLJYNSUODATTIMET JATKUU



Vanteet ja renkaat



Talvituotteet



Vinssit



Laukut ja tuulisuojat



Sähköosat



Jousitus ja voimansiirto



Pakoputket ja suutinsarjat



Ohjaus



Rungon osat ja peitteet



Jarrupalat ja rattaat



Moottori



Variaattorin osat



Maatalous-tarvikkeet



Kärkyt ja reet



ATV



ATV



ATV

KAWASAKI			
Malli	Vm.	Tuoteno.	Hinta
KVF700 Prairie	04-06	20-HF204	9,40
KRF750 Teryx	08-13	20-HF204	9,40
KVF750 Brute Force	05-14	20-HF204	9,40
KRF800 Teryx	14	20-HF204	9,40
Mule 2510,3010,4010 Diesel	00-13	20-HF129	9,80

KTM			
Malli	Vm.	Tuoteno.	Hinta
450 SX	09-11	20-HF658	8,20
450 XC 1.pitkä suodatin	08-11	20-HF155	6,40
450 XC 2.lyhyt suodatin	08-11	20-HF157	6,40
505 SX	09-11	20-HF658	8,20
525 XC 1.pitkä suodatin	08-11	20-HF155	6,40
525 XC 2.lyhyt suodatin	08-11	20-HF157	6,40

KYMCO			
Malli	Vm.	Tuoteno.	Hinta
375 MXU / Maxxer	08-12	20-HF138	9,40
400 MXU	08-12	20-HF138	9,40
450 MXU i / Maxxer i	11-12	20-HF147	9,40
500 MXU / UXV	06-12	20-HF147	9,40
550 MXU i.e	11-12	20-HF147	9,40
700 MXU i.e	13	20-HF147	9,40

POLARIS			
Malli	Vm.	Tuoteno.	Hinta
200 Pheonix	05-14	20-HF197	9,40
200 Sawtooth	07	20-HF197	9,40
300 Hawkeye	07-11	20-HF303	9,40
300 Sportsman	08-10	20-HF303	9,40
325 Magnum	00-02	20-HF303	9,40
325 Trail Boss	00-02	20-HF303	9,40
325 Xpedition	00-02	20-HF303	9,40
330 ATP	04-05	20-HF303	9,40
330 Hawkeye	06	20-HF303	9,40
330 Magnum	03-06	20-HF303	9,40
330 Trail Blazer	08-11	20-HF303	9,40
330 Trail Blazer	12-13	20-HF199	9,60
330 Trail Boss	03-11	20-HF303	9,40
330 Trail Boss	12-13	20-HF199	9,60
335 Sportsman	99-01	20-HF303	9,40
400 Sportsman	01-05	20-HF303	9,40
400 Sportsman H.O	08-11	20-HF303	9,40
400 Sportsman H.O	12-14	20-HF199	9,60
400L Xplorer	96-98	20-HF303	9,40
425 Magnum	96-98	20-HF303	9,40
425 Xpedition	00-02	20-HF303	9,40
450 Outlaw MXR 1.pitkä suodatin	08-09	20-HF155	6,40
450 Outlaw MXR 2.lyhyt suodatin	08-09	20-HF157	6,40
450 Sportsman	06-07	20-HF303	9,40
455 Diesel	99-00	20-HF303	9,40
500 ATP HO	04-05	20-HF303	9,40
500 Big Boss	98-99	20-HF303	9,40
500 Magnum	99-03	20-HF303	9,40
500 Outlaw	07	20-HF112	4,00
500 Predator	03-07	20-HF112	4,00
500 Ranger	06-12	20-HF303	9,40
500 Scrambler	96-12	20-HF303	9,40
500 Sportsman / EFI	00-11	20-HF303	9,40
500 Sportsman HO	12-14	20-HF199	9,60
500 Xplorer 4x4	97	20-HF303	9,40
525 Outlaw 1.pitkä suodatin	07-11	20-HF155	6,40
525 Outlaw 2.lyhyt suodatin	07-11	20-HF157	6,40
550 Sportsman XP	09-14	20-HF199	9,60
570 Sportsman	14	20-HF199	9,60
600 Sportsman	03	20-HF196	11,20
600 Sportsman Twin (<-10.02.2003)	04	20-HF196	11,20
600 Sportsman Twin (10.02.2003->)	04-06	20-HF198	11,20
700 Ranger 6x6 EFI	07-09	20-HF198	11,20
700 Sportsman Twin	02-04	20-HF196	11,20
700 Sportsman Twin / EFI	05-08	20-HF198	11,20
800 Ranger RZR	08-12	20-HF198	11,20
800 Sportsman / EFI	05-09	20-HF198	11,20
850 Sportsman XP	09-14	20-HF199	9,60
900 Ranger RZR XP	11-12	20-HF199	9,60
900 Ranger RZR XP	13	20-HF198	11,20
1000 Scrambler	14	20-HF199	9,60

SUZUKI			
Malli	Vm.	Tuoteno.	Hinta
LT-Z90 QuadSport	07-09	20-HF131	3,80
LT 125	83-87	20-HF131	3,80
LT-F160	91-02	20-HF131	3,80
LT160 Quadrunner	03-04	20-HF132	3,80
LT230	85-93	20-HF132	3,80
LT-F230	86-87	20-HF132	3,80
LT250	85-86	20-HF132	3,80
LT-F250	88-09	20-HF132	3,80
LT-Z250 QuadSport	04-09	20-HF132	3,80
LT 4WD	87-99	20-HF132	3,80
LT-F King Quad	91-99	20-HF132	3,80
LT300	87-89	20-HF132	3,80
LT-F300F King Quad	00-02	20-HF132	3,80
LT-F400 Eiger 2x4	02-06	20-HF138	9,40
LT-A400 Eiger 2x4 Automatic	02-06	20-HF138	9,40
LT-A400 King Quad	09-12	20-HF138	9,40
LT-F400 K7 Eiger 2WD	07	20-HF138	9,40
LT-F400F Eiger	02-09	20-HF138	9,40
LT-F400 King Quad	09-12	20-HF138	9,40
LT-A400 F / FC Eiger	02-08	20-HF138	9,40
LT-Z400 QuadSport	03-09	20-HF139	4,60
LT-A450X King Quad	07-10	20-HF139	9,40
LT-R450 QuadRacer	06-09	20-HF139	4,60
LT-F500F Quadrunner	98-02	20-HF138	9,40
LT-A500F Quadrunner	98-02	20-HF138	9,40
LT-F500F Vinson	02-07	20-HF138	9,40
LT-A500F Vinson	03-07	20-HF138	9,40
LT-A500XP King Quad	09-12	20-HF138	9,40
LTA700 King Quad	05-07	20-HF138	9,40
LTV700 Twin Peaks	04-05	20-HF204	9,40
LTA750 King Quad	08-12	20-HF138	9,40

TGB			
Malli	Vm.	Tuoteno.	Hinta
425 Blade/Target		20-HF148	10,60
525 Target		20-HF148	10,60
550 Blade/Target		20-HF148	10,60

YAMAHA			
Malli	Vm.	Tuoteno.	Hinta
YFM200 N	85-89	20-HF143	9,60
YFM225	86-90	20-HF143	9,60
YFM230 BearTracker	03-04	20-HF143	9,60
YFB230 Timberwolf	92-00	20-HF143	9,60
YFB250 FW Timberwolf	94-00	20-HF143	9,60
YFM250 Bear Tracker	91-04	20-HF143	9,60
YFM250 Bruin	06	20-HF143	9,60
YFM250 R Raptor	08-12	20-HF140	6,20
YFM350 Warrior	87-95	20-HF142	9,60
YFM350 Big Bear	87-99	20-HF142	9,60
YFM350 Bruin	04-06	20-HF303	9,40
YFM350 Grizzly	07-13	20-HF204	9,40
YFM350 Wolverine 4x4	96-05	20-HF142	9,60
YFM350 Wolverine 2 WD	06-10	20-HF204	9,40
YFM350 Raptor	05-13	20-HF142	9,60
YFM400 Kodiak	94-99	20-HF142	9,60
YFM400 Kodiak	00-06	20-HF303	9,40
YFM400 Big Bear	93-12	20-HF142	9,60
YFM400 Grizzly	07-08	20-HF204	9,40
YFM450 Grizzly	07-13	20-HF204	9,40
YFM450 Kodiak	03-06	20-HF303	9,40
YFM450 Wolverine	06	20-HF303	9,40
YFM450 Wolverine	07-10	20-HF204	9,40
YFZ450	04-06	20-HF141	6,20
YFZ450	07-13	20-HF140	6,20
YXR450 Rhino	06-09	20-HF303	9,40
YFM550 Grizzly	09-13	20-HF204	9,40
YFM600 Grizzly	98-01	20-HF145	5,20
YFM660 Raptor	01-05	20-HF147	9,40
YFM660 Grizzly	02-06	20-HF303	9,40
YFM660 Grizzly	07-08	20-HF204	9,40
YXR660 Rhino	04-06	20-HF303	9,40
YFM700 Grizzly	07-13	20-HF204	9,40
YFM700 Raptor	06-13	20-HF145	5,20
YXR700 Rhino	08-13	20-HF204	9,40

MÄNNÄT

Korkealaatuiset Namura-männät ovat teflon-pinnoitettuja, joka pienentää kitkaa ja vähentää männän lämpölaajenemista. Männän laki on anodisoitu, joka vähentää merkittävästi männän kuumentumista. Männän mukana toimitetaan männänrenkaat, männäntappi sekä lukkorenkaat.



ARCTIC CAT	Vm	Koko	Tuotenumero	Hinta
300 2x4,4x4	1998-05	68,47 vakio	79-30001	100,70
		68,97	79-30001-02	100,70
		69,47	79-30001-04	100,70
400 DVX	2004-08	90,0 vakio	79-30002	131,10
		90,5	79-30002-02	131,10
500	2003-09	87,45	79-30050	131,10
		87,46	79-30050-B	131,10
		87,47	79-30050-C	131,10

CAN-AM	Vm	Koko	Tuotenumero	Hinta
OUTLANDER 400	2003-14	91,00 vakio	79-80001	113,00
		91,50	79-80001-1	113,00
		92,00	79-80001-2	113,00
		92,50	79-80001-3	113,00
OUTLANDER 800	2006-14	91,00 vakio	79-80001	113,00
RENEGADE 800	2006-14	91,50	79-80001-1	113,00
		92,00	79-80001-2	113,00
		92,50	79-80001-3	113,00

HONDA	Vm	Koko	Tuotenumero	Hinta
300 TRX	1988-2008	74,0 vakio	79-10002	101,90
		74,5	79-10002-02	101,90
		75,0	79-10002-04	101,90
350 TRX	1999-08	78,5 vakio	79-10007	113,90
		79,0	79-10007-02	113,90
		79,5	79-10007-04	113,90
400 TRX	1995-04	86,0 vakio	79-10001	113,90
		86,5	79-10001-02	113,90
		87,0	79-10001-04	113,90
420 TRX RANCHER	2007-14	86,5	79-10042	113,90
450 TRX FOREMAN	1998-04	87,0	79-10042-02	113,90
		90,0 vakio	79-10000	113,90
450 R SPORTRAX 10.2:1	2003-06	90,5	79-10000-02	113,90
		91,0	79-10000-04	113,90
		94,0 vakio	79-10045	113,90
500 TRX RUBICON	2000-14	94,5	79-10045-02	113,90
		92,0 vakio	79-10008	113,90
		92,5	79-10008-02	113,90
650 TRX RINCON	2003-05	93,0	79-10008-04	113,90
		100,0 vakio	79-10009	131,10
		100,5	79-10009-02	131,10
		101,0	79-10009-04	131,10

KAWASAKI	Vm	Koko	Tuotenumero	Hinta
300 KLF	1986-04	76,0 vakio	79-20000	113,90
300 KEF	2002-04	76,5	79-20000-02	113,90
300 KVF	1986-02	77,0	79-20000-04	113,90
400 KFX	2003-06	90,0 vakio	79-30002	131,10
400 KLX	2003-06	90,5	79-30002-02	131,10
		91,0	79-30002-04	131,10

POLARIS	Vm	Koko	Tuotenumero	Hinta
250	1985-02	72,0 vakio	79-50000	99,80
		72,5	79-50000-02	99,80
		73,0	79-50000-04	99,80
325 Trailboss, Magnum	2000-02	77,95	79-50024	113,00
		78,45	79-50024-02	113,00
		78,95	79-50024-04	113,00

POLARIS	Vm	Koko	Tuotenumero	Hinta
330 TrailBlazer, Magnum, ATP	2003-13	78,45	79-50025	113,00
		78,95	79-50025-02	113,00
		79,45	79-50025-04	113,00
400	1994-03	83,0	79-50002	100,70
		83,5	79-50002-02	100,70
		84,0	79-50002-04	100,70
SPORTSMAN 400, 400 HO	2001-13		79-50026	113,00
			79-50026-02	113,00
			79-50026-04	113,00
500	1996-13	92,0 vakio	79-50004	100,70
		92,5	79-50004-02	100,70
		93,0	79-50004-04	100,70
700 Sportsman	2002-08	79,96 vakio	79-50070	130,00
		79,97	79-50070-B	130,00
		79,98	79-50070-C	130,00
800 Sportsman	2005-14	79,95	79-50080	130,00
		79,96	79-50080-B	130,00
		79,97	79-50080-C	130,00
800 HO	2008-14	79,95	79-50081	130,00
		79,96	79-50081-B	130,00
		79,97	79-50081-C	130,00

SUZUKI	Vm	Koko	Tuotenumero	Hinta
300 LTF KING QUAD	1991-03	68,5 vakio	79-30001	100,70
		69,0	79-30001-02	100,70
		69,5	79-30001-04	100,70
400 LTZ	2003-12	90,0 vakio	79-30002	131,10
		90,5	79-30002-02	131,10
		91,0	79-30002-04	131,10
500 KING QUAD	2009-12	87,45 vakio	79-30053	131,10
		87,46	79-30053-B	131,10
		87,47	79-30053-C	131,10

YAMAHA	Vm	Koko	Tuotenumero	Hinta
350	1987-06	83,0 vakio	79-40005	113,90
350 RAPTOR	2004-11	83,5	79-40005-02	113,90
350 Grizzly	2007-14	84,0	79-40005-04	113,90
400	1993-07	83,0 vakio	79-40006	99,80
400 BIG BEAR	2000-12	83,5	79-40006-02	99,80
		84,0	79-40006-04	99,80
400 GRIZZLY	2007-14	84,5 vakio	79-40008	113,90
400 KODIAK	2000-06	85,0	79-40008-02	113,90
		85,5	79-40008-04	113,90
450 YFZ	2004-14	95,0 vakio	79-40009	113,90

450 Grizzly, Kodiak, Wolverine	2003-14	84,45 vakio	79-40011	116,00
		84,95	79-40011-02	116,00
		85,45	79-40011-04	116,00
600 GRIZZLY	1998-01	95,0 vakio	79-40007	130,00
		95,5	79-40007-02	130,00
		96,0	79-40007-04	130,00
660 GRIZZLY, RHINO, RAPTOR	2001-07	100,0 vakio	79-40004	113,90
		100,5	79-40004-02	113,90
		101,0	79-40004-04	113,90
700 Grizzly	2007-13	101,97 vakio	79-40012	130,00
700 Raptor	2006-13	101,98	79-40012-B	130,00
700 Rhino	2008-13	101,99	79-40012-C	130,00

KAASUTINLAIPAT

POLARIS	KAASUTINLAIPPA	Hinta
87-070	(Korvaa Alkup.nr 3083412,3085013)	18,70
1985-86	SCRAMBLER	
1986-99	TRAIL BOSS	
1989-92	BIG BOSS	
1990-06	TRAIL BLAZER	
1993-94	250 4x4,6x6	
1993-94	300 4x4,6x6	
1996	XPRESS 400	
1996-97	XPRESS 300	
1997	SPORT 400	
1997-02	XPLORER 300	

79-07121



YAMAHA	KAASUTINLAIPPA	Hinta
79-07121	(Korvaa Alkup.nr 3HN-13586-01-00)	34,50
1993-99	KODIAK 500	
79-07122	(Korvaa Alkup.nr TUY-13586-02-00)	28,50
	YFM 350 X WARRIOR	



87-070



79-07122



Vanteet ja renkaat



Talvituotteet



Vinsit



Laukut ja tuulisuojat



Sähköosat



Jousitus ja voimansiirto



Pakoputket ja suutinsarjat



Ohjaus



Rungon osat ja peitteet



Jarrupalat ja rattaat



Moottori



Variaattorin osat



Maatalous-tarvikkeet



Kärkyt ja reet



ATV



185



MÄNNÄT



WISECON piialumiiniseoksesta valmistetut takomännät ovat omaa luokkaansa. Lujina ja sitkeinä nämä männät sallivat suuremmat välykset kun valumännät. Sitkeyden ja lujuuden vuoksi männät pystytään valmistamaan keveyempänä kun

valumännät, ja samalla kun kevyt mäntä sallii suuremmat kierrosluvut, niin se myös rasittaa laakewrit vähemmän. Pidennät siis elinikää ei pelkäästään männälle käyttämällä WISECON takomäntiä!

* Tähdellä merkityt ovat tilaustuotteita.

ARCTIC CAT	Vm	Halk.	Mäntäsarja	Männät	Hinta	Tapit	Hinta	Sokat	Hinta	Yläpään.tiivrsj.	Hinta
250 2x4, 4x4	1999-05	66.0x67		94-22-4382	156,00	94-15-259*	19,10	94-15-16CW	3,10	94-24-5066	48,00
		66.50		94-22-4382-02*	156,00						
		67.00		94-22-4382-04*	156,00						
300 2x4, 4x4	1998-05	68.5x76		94-22-4673-02*	172,00	94-15-533*	19,90	94-15-17CW	3,10	94-24-5743	53,00
		69.50		94-22-4673-04*	172,00						
400 DVX	2004-08	90.0x62.6		94-22-4714	206,00	94-15-549*	19,90	94-15-20CW	3,10	94-24-5881	78,00
13.5:1 Hi comp	2004-08	90.0x62.6		94-22-4714-08*	229,00						
400 DVX	2004-08	90.0x62.6		94-22-4713	206,00	94-15-549*	19,90	94-15-20CW	3,10	94-24-5881	78,00
12.2:1 vakio	2009-13	92.0x82		94-22-4713-08*	229,00						
550	2005-12	98.0x85		94-22-40107	206,00	94-15-626*	19,90	94-15-23CW	3,10		
650 H1	2009-12	102.0x85		94-22-40099	228,00	94-15-626*	19,90				
700	2009-12	102.0x85		94-22-40080	228,00						
1000	2009-14	92.0x71.6		94-22-40081	228,00	94-15-549*	19,90	94-15-20CW	3,10		
CAN-AM											
OUTLANDER 400	2003-13	91.0x61.5		94-22-40030	172,00	94-15-641*	19,90			94-24-6918	108,00
		92.00		94-22-40030-02*	172,00						
		93.00		94-22-40030-04*	172,00						
OUTLANDER 500	2007-13	82.0x47		94-22-40028	172,00			94-15-18CW	3,10	94-24-6917	108,00
		82.50		94-22-40028-02*	172,00						
		83.00		94-22-40028-04*	172,00						
OUTLANDER 650	2006-13	82.0x62		94-22-40029	172,00			94-15-18CW	3,10	94-24-6912	108,00
		82.50		94-22-40029-02*	172,00						
		83.00		94-22-40029-04*	172,00						
OUTLANDER 800/800R	2006-13	91.0x62		94-22-40030	172,00	94-15-641*	19,90			94-24-6918 (2kpl)	108,00
				94-22-40030-02*	172,00						
				94-22-40030-04*	172,00						
HONDA 4-T											
TRX 250EX	2001-08	68.5x62.2		94-22-4935	172,00	94-15-525*	19,90	94-15-15CW	3,10		
		69.00		94-22-4935-02*	172,00						
		69.50		94-22-4935-04*	172,00						
TRX 300 EX	1992-08	74x65.5		94-21-1026	212,00	94-15-523*	19,90	94-15-17CW	3,10	94-24-5463	43,00
		74.50		94-21-1027*	212,00						
		75.00		94-21-1028*	229,00						
		75.50		94-21-1029*	229,00						
		76.00		94-22-4574-08*	205,00						
TRX 400EX	1999-08	85.0x70.0		94-21-1031	279,00	94-15-520*	19,90	94-15-20CW	3,10	94-24-5514	91,50
TRX 400X	2009-14	85.50		94-21-1032*	279,00						
		86.00		94-21-1033*	279,00						
		87.00		94-21-1034*	306,00						
		88.00		94-21-1035*	306,00						
TRX 400	1995-03	86.0x68.0		94-22-4669	205,00	94-15-475*	19,90	94-15-20CW	3,10	94-24-5736	52,00
FOREMAN	2007-14	86.5x71.5		94-22-4669-04*	205,00						
TRX 420 RANCHER	2004-05	94.0x64.8		94-22-40050	172,00	94-15-475*	19,90	94-15-19CW	3,10		
		96.00		94-22-40050-02*	189,00						
		87.50		94-22-40050-04*	189,00						
TRX 450R	2004-05	94.0x64.8		94-22-4849	251,00	94-15-656*	19,90	94-15-21CW	3,10	94-24-6282	114,00
11.5:1 Hi Comp.	2006-14	96.0x62.0		94-22-4899	221,00						
TRX 450R	2003-05	100x62.6		94-22-40067	206,00	94-15-660*	19,90	94-15-19CW	3,10	94-24-6442	109,00
12:1 Hi Comp.	2006-14	100x82.6		94-22-40066	206,00						
TRX 650	2003-05	100x62.6		94-22-40066-04*	206,00						
TRX 680	2006-14	103.00									



MÄNNÄT JATKUU



* Tähdellä merkityt ovat tilaustuotteita.

KAWASAKI 4-T	Vm	Halk.	Mäntäsarja	Hinta	Männät	Hinta	Tapit	Hinta	Sokat	Hinta	Yläpään.tiivrsj.	Hinta				
300	1986-03	76.0x64.0	94-21-1050	236,00	94-22-4671	172,00	94-15-555*	19,90	94-15-18CW	3,10	94-24-5740	49,50				
			94-21-1051*	236,00	94-22-4671-02*	172,00										
			94-21-1052*	236,00	94-22-4671-04*	172,00										
			94-21-1053*	255,00	94-22-4671-06*	205,00										
KFX 400 13.5:1 Hi Comp	2003-06	90.0x62.6			94-22-4714	206,00	94-15-549*	19,90	94-15-20CW	3,10	94-24-5881	78,00				
					94-22-4714-08*	229,00										
					94-22-4974	249,00	94-15-656*	19,90	94-24-6651	82,00						
					94-22-4782	172,00	94-15-520*	19,90	94-15-20CW	3,10						
BRUTE FORCE					94-22-4782-02*	172,00										
					94-22-4782-04*	172,00										
					94-22-4782-06*	172,00										
					94-22-4782-08*	172,00	94-15-641*	19,90	94-24-6162	149,00						
KFX 700	2004-10	82.0x66.0			94-22-4896	172,00	94-15-641*	19,90	94-15-20CW	3,10	94-24-6162	149,00				
					94-22-4896-08*	172,00	94-15-641*	19,90	94-15-20CW	3,10	94-24-6440	152,00				
PRAIRIE 700	2004-06				94-22-4897	183,00										
					94-22-4897-08*	205,00										
750	2005-11	85.0x66.0			94-22-4897-08	205,00										
BRUTE FORCE					94-22-4897-08	205,00										
POLARIS 2-T	Vm	Halk.	Mäntäsarja	Hinta	Männät	Hinta	Tapit	Hinta	Sokat	Hinta	Yläpään.tiivrsj.	Hinta				
250	1984-	72.0x60.0	94-21-1084	190,00	94-22-536	144,00	94-15-459	14,30	94-15-18CW	3,10	94-24-5326	24,50				
			94-21-1085*	190,00	94-22-536-02*	144,00										
			94-21-1086*	190,00	94-22-536-04*	144,00										
			94-21-1087*	204,00	94-22-536-06*	155,00										
			94-21-1088*	204,00	94-22-536-08*	155,00	94-15-513	14,30	94-15-18CW	3,10	94-24-5667	24,50	94-15-1014	22,00		
							94-22-721	135,00								
							94-22-721-02*	135,00								
							94-22-721-04*	135,00								
							94-22-721-06*	145,00								
							94-22-721-08*	145,00								
							94-22-639	145,00	94-15-278	14,30	94-15-18CW	3,10	94-24-5423	28,50	94-15-1002	22,00
							94-22-639-02*	145,00								
300	-2003	83.0x70.0	94-21-1106	181,00	94-22-675	145,00	94-15-278	14,30	94-15-18CW	3,10	94-24-5517	35,00				
			94-21-1107*	181,00	94-22-675-01*	145,00										
			94-21-1108*	181,00	94-22-675-02*	145,00										
			94-21-1109*	181,00	94-22-675-04*	145,00										
			94-21-1110*	194,00	94-22-675-06*	155,00										
			94-21-1111*	194,00	94-22-675-08*	155,00										
							94-22-639-04*	145,00								
							94-22-639-06*	156,00								
							94-22-639-08*	156,00								
							94-22-675	145,00								
							94-22-675-01*	145,00								
							94-22-675-02*	145,00								
400		80.0x70.0	94-21-1106	181,00	94-22-675	145,00	94-15-278	14,30	94-15-18CW	3,10	94-24-5517	35,00				
			94-21-1107*	181,00	94-22-675-01*	145,00										
			94-21-1108*	181,00	94-22-675-02*	145,00										
			94-21-1109*	181,00	94-22-675-04*	145,00										
			94-21-1110*	194,00	94-22-675-06*	155,00										
			94-21-1111*	194,00	94-22-675-08*	155,00										
							94-22-639-04*	145,00								
							94-22-639-06*	156,00								
							94-22-639-08*	156,00								
							94-22-675	145,00								
							94-22-675-01*	145,00								
							94-22-675-02*	145,00								
POLARIS 4-T	Vm	Halk.	Mäntäsarja	Hinta	Männät	Hinta	Tapit	Hinta	Sokat	Hinta	Yläpään.tiivrsj.	Hinta				
500	1996-05	92.0x75.0	94-22-4677	175,00	94-22-4677	175,00	94-15-591	14,30	94-15-23CW	3,10	94-24-5747	58,00				
			94-22-4677-02*	175,00	94-22-4677-04*	175,00										
			94-22-4677-06*	175,00	94-22-4677-08*	175,00										
PREDATOR	2003-07	99.2x64.6	94-22-4807	173,00	94-22-4807	201,00	94-15-626	14,30			94-24-6195	79,00				
			94-22-4914*	201,00	94-22-4914*	201,00										
OUTLAW 450	2008-11	89.0x72.0	94-22-4942	192,00	94-22-4942	192,00	94-15-553	14,30	94-15-20CW	3,10	94-24-5883	55,50				
			94-22-4942-08*	217,00	94-22-4942-08*	217,00										
Hi Comp.	2006-07	99.2x64.6	94-22-4807	173,00	94-22-4807	201,00	94-15-626	14,30			94-24-6195	79,00				
			94-22-4914*	201,00	94-22-4914*	201,00										
OUTLAW 500	2007-09	95.0x72.0	94-22-4732	232,00	94-22-4732	232,00	94-15-641	14,30	94-15-20CW	3,10	94-24-5885	82,50				
			94-22-4732-08*	257,00	94-22-4732-08*	257,00										
SPORTSMAN 800	2005-12	80.0x76.5	94-22-4961	161,00	94-22-4961	161,00										
			94-22-40106	172,00	94-22-40106	172,00										
SPORTSMAN 850 XP	2013-	87.0x71	94-21-1861	232,00	94-21-1861	232,00										



MÄNNÄT JATKUU



* Tähdellä merkityt ovat tilaustuotteita.

SUZUKI 4-T	Vm	Halk.	Mäntäsarja	Hinta	Männät	Hinta	Tapit	Hinta	Sokat	Hinta	Yläpään.tiivrsj.	Hinta
250	1987-95	66.0x67.0	94-21-1010	159,00	94-22-4382	120,00	94-15-259	14,30	94-15-16CW	3,10	94-24-5896	46,50
		66.50	94-21-1011*	159,00	94-22-4382-02*	120,00						
		67.00	94-21-1012*	159,00	94-22-4382-04*	120,00						
		67.50	94-21-1013*	171,00	94-22-4382-06*	132,00						
		68.00	94-21-1014*	171,00	94-22-4382-08*	132,00						
300	1991-02	68.5x70.0			94-22-4673-02	124,00	94-15-533	14,30	94-15-17CW	3,10	94-24-5743	45,00
		69.50			94-22-4673-04*	124,00						
Z400	2000-13	90.0x62.6			94-22-4714-00	191,00	94-15-549	14,30	94-15-20CW	3,10	94-24-5881	37,50
Hi Comp.		92.00			94-22-4714-08*	198,00						
LTR 450	2006-12	95.5x62.8	94-21-1425	316,00	94-22-4912	230,00						
Hi Comp.		98.00	94-21-1426*	335,00	94-22-4912-10*	250,00						89,50
YAMAHA 2-T	Vm	Halk.	Mäntäsarja	Hinta	Männät	Hinta	Tapit	Hinta	Sokat	Hinta	Yläpään.tiivrsj.	Hinta
200 BLASTER	-2006	66.0x57.0	94-21-1089	156,00	94-22-573	115,00	94-15-486	14,30	94-15-16CW	3,10	94-24-5232	43,50
		66.25	94-21-1090*	156,00	94-22-573-01*	115,00						
		66.50	94-21-1091*	156,00	94-22-573-02*	115,00						
		66.75	94-21-1092*	156,00	94-22-573-03*	115,00						
		67.00	94-21-1093*	156,00	94-22-573-04*	115,00						
350 BANSHEE	-2007	64.0x54.0			94-22-513	126,00	94-15-486	14,30	94-15-16CW	3,10	94-24-5231	37,50
		64.25			94-22-513-01*	126,00						
		64.50			94-22-513-02*	126,00						
		64.75			94-22-513-03*	126,00						
		65.00			94-22-513-04*	126,00						
		65.25			94-22-513-05*	126,00						
		65.50			94-22-513-06*	126,00						
		66.00			94-22-513-07*	126,00						
		66.25			94-22-513-08*	126,00						
		66.50			94-22-513-09*	126,00						22,00
YAMAHA 4-T	Vm	Halk.	Mäntäsarja	Hinta	Männät	Hinta	Tapit	Hinta	Sokat	Hinta	Yläpään.tiivrsj.	Hinta
250	1990-02	71.0x58.0	94-21-1054	177,4	94-22-4675	130,00	94-15-596	14,30	94-15-16CW	3,10	94-24-5745	53,50
		71.50	94-21-1055*	177,4	94-22-4675-02*	130,00						
		72.00	94-21-1056*	177,4	94-22-4675-04*	130,00						
250 RAPTOR	2008-13	74.0x58.0			94-22-4950	141,00	94-15-688	14,30	94-15-17CW	3,10	94-24-5746	50,00
		76.00			94-22-4950-08*	141,00						
350	1987-04	83.0x64.5	94-21-1018	179,00	94-22-4419	141,00	94-15-376	14,30	94-15-19CW	3,10	94-24-5746	50,00
350 RAPTOR	2005-13	83.50	94-21-1019*	179,00	94-22-4419-02*	141,00						
350 GRIZZLY	2007-14	84.00	94-21-1020*	179,00	94-22-4419-04*	141,00						
400 KODIAK	1993-05	83.0x71.5			94-22-4676	156,00	94-15-376	14,30	94-15-19CW	3,10	94-24-5746	50,00
400 BIG BEAR	2003-08	83.50			94-22-4676-02*	156,00						
		84.00			94-22-4676-04*	156,00						
450 GRIZZLY	2006-14	84.5x75.0			94-22-4939	169,00	94-15-520	14,30	94-15-20CW	3,10		
450 KODIAK	2003-06	85.00			94-22-4939-02*	169,00						
450 RHINO	2006-09	85.50			94-22-4939-04*	169,00						
450 WOLVERINE	2006-10											
YFZ 450	2004-13	95.0x62.0			94-22-4835	233,00	94-15-641	14,30	94-15-20CW	3,10	94-24-6129	100,00
Hi Comp.		96.00			94-22-4835-04*	233,00						
600 GRIZZLY	1998-01	95.0x84.0			94-22-4797	171,00	94-15-22CW	14,30	94-15-22CW	3,10	94-24-5726	64,00
		96.00			94-22-4797-04*	171,00						
660 GRIZZLY	2002-08	100x84.0			94-22-4966	171,00	94-15-22CW	14,30	94-15-22CW	3,10		
		100.5			94-22-4966-02*	171,00						
		101.0			94-22-4966-04*	171,00						
700 GRIZZLY	2007-13	102x84.0			94-22-4902	171,00						
700 RHINO	2008-09	103.0			94-22-4902-04*	171,00						



MÄNNÄT

uutuus!



ProX männät tarkkuuskoneistetaan viimeisimmällä CNC-tekniikalla. Metalliseos on sama, jota käyttävät kaikki suurimmat japanilaiset moottorivalmistajat. Sen etuina ovat alhainen lämpölaajeneminen ja vähäinen kitka. ProX-mäntäsarja on ykkösvaihtoehto korvaamaan alkuperäinen mäntä moottoripyörissä, mönkijöissä, vesijeteissä ja mopoissa.

Suurimmassa osassa ProXin mäntiä on kalvopinnoite. ProXin alkuperäistyyppinen Tin-pinnoite vähentää kulumista kylmäkäynnistyksissä. Pinnoite vähentää myös kitkaa. Musta pinnoite on sekoitus eri materiaaleja ja parantaa suorituskykyä.



ProX männät Nicasil sylintereihin

Nykypäivän sylinterit ovat useimmiten Nicasil päällysteisiä. Sen tähden ProX mäntiä on saatavana useita kokoja A,B,C,D -ylikoot.



ProX männät putkittuihin sylintereihin.

Kokoja saatavana alkuperäisestä jopa 2mm ylikokoon. Kaikki ProX mäntäsarjat sisältävät täyd. männän. (Mäntä,renkaat,tappi ja sokat)



ProX yläpään tiivistesarjat

- Sis. Kaiken tarvittavan esim. männän vaihtoon.
- Mm.kansitiiv.,alap.tiiv., ventt.varren tiivisteet



ProX täyd.tiivistesarja

- Sis. Kaikki muut tiivisteet paitsi kampiakseliin stefat



ProX kampiakselin stefat

- Valmistetaan Japanissa
- Alkuperäislaatua

MÄNTIEN SOPIVUUDET

HUOM! Punaisella merkityt eivät ole varastotuotteita. Toimitusaika on n. 1-2 viikkoa.

HONDA	Vuosi	Huom.	Koko	Mäntäsrj.	Ovh
TRX 450 R	06-14	-Std. 12.0:1	95.96	400-01-1496-A	187,50
TRX 450 R	06-14	-Std. 12.0:1	95.97	400-01-1496-B	187,50
TRX 450 R	06-14	-Std. 12.0:1	95.98	400-01-1496-C	187,50
TRX 450 R	06-14	-High 13.5:1	95.96	400-01-1497-A	206,00
TRX 450 R	06-14	-High 13.5:1	95.97	400-01-1497-B	206,00

KAWASAKI	Vuosi	Huom.	Koko	Mäntäsrj.	Ovh
KFX 400	03-06		89.96	400-01-3420-A	182,00
KFX 400	03-06		89.97	400-01-3420-B	182,00
KFX 400	03-06		89.98	400-01-3420-C	182,00
KFX 450 R	08-14	-Std. 12.5:1	95.95	400-01-4418-A	182,00
KFX 450 R	08-14	-Std. 12.5:1	95.96	400-01-4418-B	182,00
KFX 450 R	08-14	-Std. 12.5:1	95.97	400-01-4418-C	182,00
KFX 450 R	08-14	-High 13.5:1	95.95	400-01-4419-A	182,00
KFX 450 R	08-14	-High 13.5:1	95.96	400-01-4419-B	182,00



Vanteet ja renkaat



Talvutuotteet



Vinsit



Laukut ja tuulisuojat



Sähköosat



Jousitus ja voimansiirto



Pakoputket ja suutinsarjat



Ohjaus



Rungon osat ja peitteet



Jarrupalat ja rattaat



Moottori



Variaattorin osat



Maatalous-tarvikkeet



Kärryt ja reet

ATV



MÄNTIEN SOPIVUUDET JATKUU



Vanteet ja renkaat



Talvituotteet



Vinssit



Laukut ja tuulisuojat



Sähköosat



Jousitus ja voimansiirto



Pakoputket ja suutinsarjat



Ohjaukset



Rungon osat ja peitteet



Jarrupalat ja rattaat



Moottori



Variaattorin osat



Maatalous-tarvikkeet



Kärryt ja reet

KTM	Vuosi	Huom.	Koko	Mäntäsrj.	Ovh
KTM 450 XC ATV	08-09	-Std. 11.0:1	88.95	400-01-6413-A	206,00
KTM 450 XC ATV	08-09	-Std. 11.0:1	88.96	400-01-6413-B	206,00
KTM 450 XC ATV	08-09	-Std. 11.0:1	88.97	400-01-6413-C	206,00
KTM 450 XC ATV	08-09	+High 12.0:1	88.95	400-01-6414-A	214,50
KTM 450 XC ATV	08-09	-High 12.0:1	88.96	400-01-6414-B	214,50
KTM 450 SX ATV	09-10	-Std. 12.5:1	96.94	400-01-6427-A	206,00
KTM 450 SX ATV	09-10	-Std. 12.5:1	96.95	400-01-6427-B	206,00
KTM 450 SX ATV	09-10	-Std. 12.5:1	96.96	400-01-6427-C	206,00
KTM 450 SX ATV	09-10	+High 13.5:1	96.94	400-01-6428-A	206,00
KTM 450 SX ATV	09-10	-High 13.5:1	96.95	400-01-6428-B	206,00
KTM 505 SX ATV	09-10	-Std. 12.5:1	99.94	400-01-6508-A	206,00
KTM 505 SX ATV	09-10	-Std. 12.5:1	99.95	400-01-6508-B	206,00
KTM 505 SX ATV	09-10	-Std. 12.5:1	99.96	400-01-6508-C	206,00
KTM 505 SX ATV	09-10	+High 13.5:1	99.94	400-01-6509-A	224,50
KTM 505 SX ATV	09-10	-High 13.5:1	99.95	400-01-6509-B	224,50
KTM 525 XC ATV	08-12	-Std. 11.0:1	94.94	400-01-6521-A	206,00
KTM 525 XC ATV	08-12	-Std. 11.0:1	94.95	400-01-6521-B	206,00
KTM 525 XC ATV	08-12	-Std. 11.0:1	94.96	400-01-6521-C	206,00
KTM 525 XC ATV	08-12	+High 12.5:1	94.94	400-01-6522-A	224,50
KTM 525 XC ATV	08-12	-High 12.5:1	94.95	400-01-6522-B	224,50

POLARIS	Vuosi	Huom.	Koko	Mäntäsrj.	Ovh
Outlaw 450 MXR	08-10	-Std. 11.0:1	88.95	400-01-6413-A	206,00
Outlaw 450 MXR	08-10	-Std. 11.0:1	88.96	400-01-6413-B	206,00
Outlaw 450 MXR	08-10	-Std. 11.0:1	88.97	400-01-6413-C	206,00
Outlaw 450 MXR	08-10	+High 12.0:1	88.95	400-01-6414-A	214,50
Outlaw 450 MXR	08-10	-High 12.0:1	88.96	400-01-6414-B	214,50
Outlaw 525	07-11	-Std. 11.0:1	94.94	400-01-6521-A	206,00
Outlaw 525	07-11	-Std. 11.0:1	94.95	400-01-6521-B	206,00
Outlaw 525	07-11	-Std. 11.0:1	94.96	400-01-6521-C	206,00
Outlaw 525	07-11	+High 12.5:1	94.94	400-01-6522-A	224,50
Outlaw 525	07-11	-High 12.5:1	94.95	400-01-6522-B	224,50

SUZUKI	Vuosi	Huom.	Koko	Mäntäsrj.	Ovh
LT 50	84-06		41.00	301-01-3001-000	41,50
LT 50	84-06		41.25	301-01-3001-025	41,50
LT 50	84-06		41.50	301-01-3001-050	41,50
LT 50	84-06		41.75	301-01-3001-075	41,50
LT 50	84-06		42.00	301-01-3001-100	41,50
LT 50	84-06		42.25	301-01-3001-125	41,50
LT 50	84-06		42.50	301-01-3001-150	41,50
LT 50	84-06		43.00	301-01-3001-200	41,50
LT 80	87-06		50.00	400-01-3180-000	73,00
LT 80	87-06		50.50	400-01-3180-050	73,00
LT 80	87-06		51.00	400-01-3180-100	73,00
LT 80	87-06		51.50	400-01-3180-150	73,00
LT-Z 400	03-14	-Std. 12.2:1	89.96	400-01-3420-A	182,00
LT-Z 400	03-14	-Std. 12.2:1	89.97	400-01-3420-B	182,00
LT-Z 400	03-14	-Std. 12.2:1	89.98	400-01-3420-C	182,00
LT-Z 400	03-14	+High 13.5:1	89.96	400-01-3404-A	198,50
LT-Z 400	03-14	-High 13.5:1	89.97	400-01-3404-B	198,50

SUZUKI	Vuosi	Huom.	Koko	Mäntäsrj.	Ovh
LT-R 450	06-11	-Std. 11.7:1	95.46	400-01-3406-A	197,00
LT-R 450	06-11	-Std. 11.7:1	95.47	400-01-3406-B	197,00
LT-R 450	06-11	-Std. 11.7:1	95.48	400-01-3406-C	197,00
LT-R 450	06-11	-High 13.0:1	95.46	400-01-3407-A	214,50
LT-R 450	06-11	-High 13.0:1	95.47	400-01-3407-B	214,50

YAMAHA	Vuosi	Huom.	Koko	Mäntäsrj.	Ovh
YFM 350 Warrior	87-04	-Std. 9.2:1	83	400-01-2487-000	131,00
YFM 350 Warrior	87-04	-Std. 9.2:1	83.50	400-01-2487-050	131,00
YFM 350 Warrior	87-04	-Std. 9.2:1	84	400-01-2487-100	131,00
YFM 350 Raptor	05-13	-Std. 9.2:1	83	400-01-2487-000	131,00
YFM 350 Raptor	05-13	-Std. 9.2:1	83.50	400-01-2487-050	131,00
YFM 350 Raptor	05-13	-Std. 9.2:1	84	400-01-2487-100	131,00
YFM 350 Bruin	04-06	-Std. 9.2:1	83	400-01-2487-000	131,00
YFM 350 Bruin	04-06	-Std. 9.2:1	83.50	400-01-2487-050	131,00
YFM 350 Bruin	04-06	-Std. 9.2:1	84	400-01-2487-100	131,00
YFM 350 Grizzly	07-14	-Std. 9.2:1	83	400-01-2487-000	131,00
YFM 350 Grizzly	07-14	-Std. 9.2:1	83.50	400-01-2487-050	131,00
YFM 350 Grizzly	07-14	-Std. 9.2:1	84	400-01-2487-100	131,00
YFZ 450	04-09	-Std. 12.0:1	94.95	400-01-2435-A	187,50
YFZ 450	04-09	-Std. 12.0:1	94.96	400-01-2435-B	187,50
YFZ 450	04-09	-Std. 12.0:1	94.97	400-01-2435-C	187,50
YFZ 450	04-09	-High 13.0:1	94.95	400-01-2436-A	204,50
YFZ 450	04-09	-High 13.0:1	94.96	400-01-2436-B	204,50

YFZ 450	12-13	-Std. 11.4:1	94.95	400-01-2435-A	187,50
YFZ 450	12-13	-Std. 11.4:1	94.96	400-01-2435-B	187,50
YFZ 450	12-13	-Std. 11.4:1	94.97	400-01-2435-C	187,50
YFZ 450	12-13	-High 12.4:1	94.95	400-01-2436-A	204,50
YFZ 450	12-13	-High 12.4:1	94.96	400-01-2436-B	204,50

YFZ 450 R	09-14	-Std. 11.6:1	94.95	400-01-2435-A	187,50
YFZ 450 R	09-14	-Std. 11.6:1	94.96	400-01-2435-B	187,50
YFZ 450 R	09-14	-Std. 11.6:1	94.97	400-01-2435-C	187,50
YFZ 450 R	09-14	-High 12.6:1	94.95	400-01-2436-A	204,50
YFZ 450 R	09-14	-High 12.6:1	94.96	400-01-2436-B	204,50

YFM 700 R Raptor	06-14	-Std. 9.2:1	101.94	400-01-2706-A	182,00
YFM 700 R Raptor	06-14	-Std. 9.2:1	101.95	400-01-2706-B	182,00
YFM 700 R Raptor	06-14	-Std. 9.2:1	101.96	400-01-2706-C	182,00
YFM 700 R Raptor	06-14	-High 11.0:1	101.94	400-01-2707-A	198,50
YFM 700 R Raptor	06-14	-High 11.0:1	101.95	400-01-2707-B	198,50

YFM 700 F Grizzly	07-13	-Std. 9.2:1	101.94	400-01-2706-A	182,00
YFM 700 F Grizzly	07-13	-Std. 9.2:1	101.95	400-01-2706-B	182,00
YFM 700 F Grizzly	07-13	-Std. 9.2:1	101.96	400-01-2706-C	182,00
YFM 700 F Grizzly	07-13	-High 11.0:1	101.94	400-01-2707-A	198,50
YFM 700 F Grizzly	07-13	-High 11.0:1	101.95	400-01-2707-B	198,50

YXR 700 Rhino	08-13	-Std. 9.2:1	101.94	400-01-2706-A	182,00
YXR 700 Rhino	08-13	-Std. 9.2:1	101.95	400-01-2706-B	182,00
YXR 700 Rhino	08-13	-Std. 9.2:1	101.96	400-01-2706-C	182,00
YXR 700 Rhino	08-13	-High 11.0:1	101.94	400-01-2707-A	198,50
YXR 700 Rhino	08-13	-High 11.0:1	101.95	400-01-2707-B	198,50

KIERTOKANKISARJAT

HUOM! Punaisella merkityt eivät ole varastotuotteita. Toimitusaika on n. 1-2 viikkoa.

HONDA	Vuosi	Kiertokankisrj.	Ovh
TRX 450 R	06-14	400-03-1405	203,50

KAWASAKI	Vuosi	Kiertokankisrj.	Ovh
KFX 400	03-06	400-03-3402	189,00

KTM	Vuosi	Kiertokankisrj.	Ovh
KTM 450 XC ATV	08-09	400-03-6520	260,00
KTM 450 SX ATV	09-10	400-03-6427	222,00
KTM 505 SX ATV	09-12	400-03-6508	222,00
KTM 525 XC ATV	08-12	400-03-6520	260,00

POLARIS	Vuosi	Kiertokankisrj.	Ovh
Outlaw 450 MXR	08-10	400-03-6520	260,00
Outlaw 525	07-11	400-03-6520	260,00

SUZUKI	Vuosi	Kiertokankisrj.	Ovh
LT-Z 400	03-14	400-03-3402	189,00

YAMAHA	Vuosi	Kiertokankisrj.	Ovh
YFZ 450	04-05	400-03-2434	189,00
YFZ 450	06-09	400-03-2436	189,00



ATV



MÄNNÄNTAPIN LAAKERIT

SUZUKI	Vuosi	M-tapin laakeri	Ovh
LT 50	84-06	301-21-3001	9,00
LT 80	87-06	301-21-3001	9,00

TIIVISTESARJAT

HONDA	Vuosi	Yläp.tiiv.srj	Ovh	Täyd.tiiv.srj	Ovh
TRX 450 R	06-14	400-35-1496	89,00		
KAWASAKI	Vuosi	Yläp.tiiv.srj	Ovh	Täyd.tiiv.srj	Ovh
KFX 400	03-06	400-35-3423	50,00	400-34-3423	134,50
KFX 450 R	08-13	400-35-4408	73,50	400-34-4408	165,00
KTM	Vuosi	Yläp.tiiv.srj	Ovh	Täyd.tiiv.srj	Ovh
KTM 450 XC ATV	08-09	400-35-6428	89,00	400-34-6428	160,00
KTM 450 SX ATV	09-10	400-35-6429	89,00	400-34-6429	124,00
KTM 505 SX ATV	09-10	400-35-6508	89,00	400-34-6508	160,00
KTM 525 XC ATV	08-11	400-35-6528	89,00	400-34-6528	160,00
POLARIS	Vuosi	Yläp.tiiv.srj	Ovh	Täyd.tiiv.srj	Ovh
Outlaw 525	07-11	400-35-6528	89,00	400-34-6528	160,00
SUZUKI	Vuosi	Yläp.tiiv.srj	Ovh	Täyd.tiiv.srj	Ovh
LT 50	84-06	400-35-3001	15,00		
LT 80	87-06	400-35-3180	15,00	400-34-3180	59,00
LT-Z 400	03-08	400-35-3423	50,00	400-34-3423	134,50
LT-Z 400	09-12	400-35-3423	50,00	400-34-3424	134,50
LT-Z 400	2013	400-35-3423	50,00		
LT-R 450	06-08	400-35-3426	71,50	400-34-3426	176,00
LT-R 450	09-11	400-35-3426	71,50	400-34-3429	176,00
YAMAHA	Vuosi	Yläp.tiiv.srj	Ovh	Täyd.tiiv.srj	Ovh
YZF 450	04-09	400-35-2434	69,00	400-34-2434	113,50
YZF 450 R	09-12	400-35-2439	71,50	400-34-2439	142,00
YZF 450 R	13-14	400-35-2439	71,50		
YFM 700 R Raptor	06-14	400-35-2706	93,50		
YFM 700 F Grizzly	07-13	400-35-2706	93,50		
YXR 700 Rhino	08-13	400-35-2706	93,50		

RUNKOLAAKERIT & STEFASARJAT

HONDA	Vuosi	Tuotenumero	OVH
TRX250R	87-89	400-23-CBS13087	58,50
TRX400EX/X	99-14	400-23-CBS14096	77,50
KAWASAKI	Vuosi	Tuotenumero	OVH
KXF250 Tecate	87-88	400-23-CBS43187	75,00
KFX400	03-06	400-23-CBS34000	115,50
KTM	Vuosi	Tuotenumero	OVH
KTM450SX	09-10	400-23-CBS64007	129,00
KTM450XC	08-09	400-23-CBS64003	129,00
KTM505SX	09-10	400-23-CBS64007	129,00
KTM525XC	08-12	400-23-CBS64003	129,00
POLARIS	Vuosi	Tuotenumero	OVH
Outlaw 450 MXR	08-10	400-23-CBS64003	129,00
Outlaw 525	07-11	400-23-CBS64003	129,00
SUZUKI	Vuosi	Tuotenumero	OVH
LT250R	88-92	400-23-CBS33088	63,50
LT-Z400	03-14	400-23-CBS34000	115,50
LT-R450	06-11	400-23-CBS34006	106,50
YAMAHA	Vuosi	Tuotenumero	OVH
YFS200 Blaster	88-04	400-23-CBS22088	113,50
YFS200 Blaster	05-06	400-23-CBS22105	100,50
YFZ350 Banshee	87-06	400-23-CBS23087	170,50
YFZ450	04-13	400-23-CBS24098	91,50
YZF450R	09-14	400-23-CBS24009	83,00



Vanteet ja renkaat



Talvituotteet



Vinsit



Laukut ja tuulisuojat



Sähköosat



Jousitus ja voimansiirto



Pakoputket ja suutinsarjat



Ohjaukset



Rungon osat ja peitteet



Jarrupalat ja rattaat



Moottori



Variaattorin osat



Maatalous-tarvikkeet



Kärryt ja reet

ATV



TIIVISTESARJAT

Winderosa on tiivistesarjojen markkinajohtaja maailmassa. Varmaa laatua, valmistettu USA:ssa.



Malli	Vuosi	Yläpään Tiivistesarja	Hinta	Täydellinen Tiivistesarja	Hinta
ARCTIC CAT					
250 2x4	99-05	79-810827	35,50	79-811827	76,30
250 4x4	01-05	79-810827	35,50	79-811827	76,30
300 2x4	98-04	79-810826	35,50	79-811826	76,30
300 4x4	98-05	79-810826	35,50	79-811826	76,30
400 2x4	98-01	79-810800	35,50	79-811800	94,50
400 4x4	98-00	79-810800	35,50	79-811800	94,50
400 4x4 w/AT	03-04	79-810846	48,70	79-811870	151,50
400 4x4 w/MT	01-02	79-810800	35,50	79-811800	94,50
400 4x4 w/MT	03-04	79-810846	48,70	79-811846	120,90
400 DVX	04-08	79-810847	48,70	79-811847	130,10
400 FIS 2x4 w/AT	03-04	79-810846	48,70	79-811870	151,50
400 FIS 2x4 w/MT	03-04	79-810846	48,70	79-811846	120,90
400 FIS 4x4 w/AT	03-05	79-810846	48,70	79-811870	151,50
400 FIS 4x4 w/MT	03-06	79-810846	48,70	79-811846	120,90
454 2x4	97-98	79-810800	35,50	79-811800	94,50
454 4x4	96-98	79-810800	35,50	79-811800	94,50
500 4x4 w/AT	00-02	79-810828	39,70	79-811839	146,30
500 4x4 w/MT	00-01	79-810828	39,70	79-811828	95,50
500 FIS 4x4 w/AT	02-09	79-810828	39,70	79-811839	146,30
500 FIS 4x4 w/MT	02-09	79-810828	39,70	79-811828	95,50
650 4x4 H1	05-11	79-810928	78,00	79-811928	95,50
650 4x4 H1 Mud Pro	10-11	79-810928	78,00	79-811928	95,50
650 4x4 w/AT V2	04-06	79-810879	100,70	79-811879	164,70
H2 THUNDERCAT	08-11			79-811929	185,00

CAN-AM					
DS 90 4 STROKE	02-05	79-810855	35,50		
Outlander 500 LTD 4X4	2010			79-811954	225,50
Outlander 500 STD 4X4	07-14			79-811954	225,50
Outlander 500 XT 4X4	07-14			79-811954	225,50
Outlander MAX 500 STD 4X4	07-14			79-811954	225,50
Outlander MAX 500 XT 4X4	07-14			79-811954	225,50
Renegade 500	08-14			79-811954	225,50
Renegade 500 XT	2012			79-811954	225,50
Traxter 500	99-05	79-810854	87,50	79-811854	185,00
DS650	00-07	79-810853	87,50	79-811853	164,70
Outlander 650 STD 4X4	06-14			79-811954	225,50
Outlander 650 XMR	13-14			79-811954	225,50
Outlander 650 XT 4X4	06-14			79-811954	225,50
Outlander MAX 650 STD 4X4	06-14			79-811954	225,50
Outlander MAX 650 XT 4X4	06-14			79-811954	225,50
Commander 800	11-14			79-811957	225,50
Outlander 800 STD 4X4	06-11			79-811956	225,50
Outlander 800 STD 4X4	12-14			79-811957	225,50
Outlander 800 XMR	2011			79-811956	225,50
Outlander 800 XMR	2012			79-811957	225,50
Outlander 800 XT 4X4	07-11			79-811956	225,50
Outlander 800 XT 4X4	12-14			79-811957	225,50
Outlander 800 XT4X4	2006			79-811956	225,50
Outlander 800 XXC	2011			79-811956	225,50
Outlander MAX 800 LTD 4X4	07-11			79-811956	225,50
Outlander MAX 800 LTD 4X4	2012			79-811957	225,50
Outlander MAX 800 STD 4X4	06-11			79-811956	225,50
Outlander MAX 800 STD 4X4	12-14			79-811957	225,50
Outlander MAX 800 XT 4X4	06-11			79-811956	225,50
Outlander MAX 800 XT 4X4	12-14			79-811957	225,50

CAN-AM					
Renegade 800	07-11			79-811956	225,50
Renegade 800	12-14			79-811957	225,50
Renegade 800 X	08-09			79-811956	225,50
Renegade 800 Xxc	10-11			79-811956	225,50
Renegade 800 Xxc	12-14			79-811957	225,50
Commander 1000	11-14			79-811957	225,50
Commander MAX 1000	2014			79-811957	225,50
MAVERICK 1000	13-14			79-811957	225,50
MAVERICK MAX 1000	2014			79-811957	225,50
Outlander 1000 STD 4X4	12-14			79-811957	225,50
Outlander 1000 XMR	13-14			79-811957	225,50
Outlander 1000 XT 4X4	12-14			79-811957	225,50
Outlander MAX 1000 STD 4X4	13-14			79-811957	225,50
Outlander MAX 1000 XT 4X4	13-14			79-811957	225,50
Renegade 1000	12-14			79-811957	225,50
Renegade 1000 Xxc	12-14			79-811957	225,50

HONDA					
TRX90	93-05	79-810842	32,50		
TRX90	06-14			79-811906	100,70
ATC250ES	85-87	79-810802	32,50	79-811802	83,30
ATC250SX	85-87	79-810802	32,50	79-811802	83,30
TRX250 Fourtrax	85-87	79-810802	32,50	79-811802	83,30
TRX250 Recon	97-01	79-810841	38,70	79-811841	100,70
TRX250 Recon	02-14	79-810888	48,70		
TRX250X / EX Sportrax	01-02	79-810888	48,70	79-811888	110,70
TRX250X / EX Sportrax	03-14	79-810888	48,70		
TRX300 EX	93-08			79-811801	87,50
TRX300 X	2009			79-811801	87,50
TRX350FE	00-06	79-810867	38,70	79-811867	109,70
TRX350FM Fourtrax Rancher	00-06	79-810867	38,70	79-811867	109,70
TRX350TE	00-06	79-810867	38,70	79-811867	109,70
TRX350TM Fourtrax Rancher	00-06	79-810867	38,70	79-811867	109,70
TRX400EX	99-04	79-810829	35,50	79-811829	83,30
TRX400EX	05-08	79-810829	35,50		
TRX400FA	04-07			79-811902	105,70
TRX400FGA Fourtrax Rancher 4X4	04-07			79-811902	105,70
TRX400FW Fourtrax Foreman 4X4	95-03	79-810858	45,70	79-811858	131,10
TRX400X	09-14	79-810829	35,50		
TRX450ER	06-14			79-811904	198,10
TRX450ES	98-01	79-810859	45,70	79-811859	137,30
TRX450FE/FM	02-04	79-810859	45,70	79-811859	137,30
TRX450R	2004	79-810868	79,30	79-811868	168,70
TRX450R	2005	79-810868	79,30	79-811868	168,70
TRX450R	06-09			79-811904	198,10
TRX450S	98-01	79-810859	45,70	79-811859	137,30
TRX500FA	01-14	79-810843	90,50	79-811843	161,70
TRX500FE	05-11	79-810896	80,30	79-811896	195,10
TRX500FGA	2004	79-810843	90,50	79-811843	161,70
TRX500FGA	05-08	79-810843	90,50	79-811843	161,70
TRX500FM	05-11	79-810896	80,30	79-811897	184,90
TRX500FPA	09-11	79-810843	90,50	79-811843	161,70
TRX500FPE	07-11	79-810896	80,30	79-811896	195,10
TRX500FPM	08-11	79-810896	80,30	79-811897	184,90
TRX500TM	05-06	79-810896	80,30	79-811897	184,90



TIIVISTESARJAT JATKUU

Winderosa on tiivistesarjojen markkinajohtaja maailmassa. Varmaa laatua, valmistettu USA:ssa.



KAWASAKI					
KFX50	03-06	79-810850	16,30		
KFX80	03-06	79-810849	16,30		
KLF220 Bayou	88-02	79-810803	35,50	79-811803	67,10
KSF250 Mojave	87-04	79-810804	35,50	79-811804	75,30
KEF300 Lakota	95-03	79-810805	35,50		
KLF300A Bayou	86-87	79-810805	35,50		
KLF300B Bayou	88-04	79-810805	35,50		
KLF300C Bayou 4X4	89-05	79-810805	35,50		
KVF300A Prairie 4x4	99-02	79-810805	35,50		
KVF300B Prairie 2x4	99-02	79-810805	35,50		
KVF360A & C Prairie 4x4	03-13	79-810845	45,70	79-811845	121,10
KVF360B Prairie	03-10	79-810845	45,70		
KFX400	03-06	79-810847	48,70	79-811847	130,10
KLF400 Bayou	93-99	79-810831	42,70	79-811831	124,00
KVF400A Prairie 4x4	97-98	79-810831	42,70	79-811860	124,00
KVF400B Prairie	1998	79-810831	42,70	79-811860	124,00
KVF400C Prairie 4x4	99-02	79-810831	42,70	79-811860	124,00
KVF400D Prairie	1999	79-810831	42,70		
KFX450R	08-14			79-811920	145,70
KVF650 Brute force	05-13	79-810879	100,70	79-811879	164,70
KVF650 Prairie	02-03	79-810879	100,70	79-811879	164,70
KFX 700 V-Force	04-09	79-810880	100,70		
KVF700 Prairie	04-06	79-810880	100,70		
KVF750 Brute Force	05-12	79-810881	100,70	79-811881	164,70
KVF750 Brute Force	13-14	79-810881	100,70		
KVF750 Brute Force EPS	12-14	79-810881	100,70		
TERYX 750 4X4	08-13	79-810881	100,70	79-811881	164,70
POLARIS					
Outlaw 50	08-13			79-811927	80,70
Predator 50	2007			79-811927	80,70
Outlaw 90	07-13			79-811926	80,70
Predator 90	03-04			79-811887	54,50
Predator 90	05-06			79-811908	49,90
Scrambler 90	01-03			79-811887	54,50
Sportsman 90	01-04			79-811887	54,50
Sportsman 90	05-06			79-811908	49,90
Sportsman 90	07-13			79-811926	80,70
Big Boss 250 4x6	89-92	79-810806	22,30	79-811806	34,50
Big Boss 250 6x6	91-93	79-810806	22,30	79-811806	34,50
Cyclone 250	1987	79-810806	22,30	79-811806	34,50
Scrambler 250	85-86	79-810806	22,30	79-811806	34,50
Trail Blazer 250	90-06	79-810806	22,30	79-811806	34,50
Trail Boss 250	85-99	79-810806	22,30	79-811806	34,50
Trail Boss 250 4x4	87-95	79-810806	22,30	79-811806	34,50
Xplorer 250 4X4	00-02	79-810806	22,30	79-811806	34,50
300 2x4	94-95	79-810807	22,30		
300 4X4	94-95	79-810807	22,30		
Xplorer 300 4x4	96-99	79-810807	22,30		
Xpress 300	96-99	79-810807	22,30		
Magnum 325 2x4	00-02	79-810836	54,90	79-811836	83,30
Magnum 325 4x4	00-02	79-810836	54,90	79-811836	83,30
Magnum 325 4x4 HDS	01-02	79-810836	54,90	79-811836	83,30
Trail Boss 325	00-02	79-810836	54,90	79-811836	83,30
Xpedition 325	00-02	79-810836	54,90	79-811838	126,10
ATP 330 4X4	04-05	79-810836	54,90	79-811838	126,10
Magnum 330 2x4	03-05	79-810836	54,90	79-811836	83,30
Magnum 330 4x4	2003-05	79-810836	54,90	79-811836	83,30
Trail Blazer 330	08-13	79-810836	54,90	79-811836	83,30
Trail Boss 330	03-13	79-810836	54,90	79-811836	83,30
Sportsman 335	99-00	79-810837	58,90	79-811837	80,30

POLARIS					
Worker 335	1999	79-810837	58,90	79-811837	80,30
400L 2x4	94-95	79-810808	29,50	79-811808	69,10
400L 4x4	1994	79-810808	29,50	79-811808	69,10
Big Boss 400L 6x6	94-97	79-810808	29,50	79-811808	69,10
Hawkeye 400 HO 2x4	12-14	79-810821	49,90	79-811821	80,30
Magnum 400L 6x6	96-97	79-810808	29,50	79-811808	69,10
Ranger 4x4 400	10-14	79-810821	49,90	79-811821	80,30
Scrambler 400 2x4	00-02	79-810808	29,50	79-811808	69,10
Scrambler 400 4x4	95-02	79-810808	29,50	79-811808	69,10
Sport 400	94-99	79-810808	29,50	79-811808	69,10
Sportsman 400 4x4	94-97	79-810808	29,50	79-811808	69,10
Sportsman 400 4x4	01-05	79-810821	49,90	79-811821	80,30
Sportsman 400 HO 4x4	08-14	79-810821	49,90	79-811821	80,30
Trail Blazer 400	2003	79-810808	29,50	79-811808	69,10
Xplorer 400L 4x4	95-02	79-810808	29,50	79-811808	69,10
Xpress 400L 2x4	96-97	79-810808	29,50	79-811808	69,10
Magnum 425 2x4	95-98	79-810821	49,90	79-811821	80,30
Magnum 425 4x4	95-98	79-810821	49,90	79-811821	80,30
Xpedition 425	00-02	79-810821	49,90		
Sportsman 450	06-07	79-810821	49,90	79-811821	80,30
ATP 500 4X4	04-05	79-810830	58,00		
Big Boss 500 6x6	98-03	79-810830	58,00		
Magnum 500 2x4 HDS	2002	79-810830	58,00		
Magnum 500 4x4	99-02	79-810830	58,00		
Magnum 500 4x4 HDS	2003	79-810830	58,00		
Magnum 500 4x4 HDS	01-03	79-810830	58,00		
Outlaw 500	06-07	79-810876	79,30	79-811907	128,10
Predator 500	03-04	79-810876	79,30	79-811876	128,10
Predator 500	05-07	79-810876	79,30	79-811907	128,10
Ranger 2X4 500	05-09	79-810830	58,00		
Ranger 4X4 500	99-13	79-810830	58,00		
Ranger 4x4 500 Crew	11-13	79-810830	58,00		
Ranger 4X4 500 EFI	2006			79-811903	141,30
Ranger 6X6 500	98-05	79-810830	58,00		
Scrambler 500 2x4	00-08	79-810830	58,00		
Scrambler 500 4x4	97-12	79-810830	58,00		
Sportsman 500 4x4	96-00	79-810830	58,00		
Sportsman 500 4x4 DUSE	01-02	79-810830	58,00		
Sportsman 500 4x4 HO	01-13			79-811903	141,30
Sportsman 500 4x4 RSE	99-02	79-810830	58,00		
Sportsman 500 6x6	00-08	79-810830	58,00		
Sportsman 500 EFI	2009			79-811903	141,30
Sportsman 500 EFI Tractor	2010			79-811903	141,30
Sportsman 500 X2	06-09			79-811903	141,30
Sportsman Forest 500	11-13			79-811903	141,30
Sportsman Forest Tractor 500	11-12			79-811903	141,30
Sportsman Touring 500 EFI	08-13			79-811903	141,30
Xplorer 500	1997	79-810830	58,00		
Outlaw 525 IRS	07-11			79-811921	155,80
Outlaw 525 S	08-10			79-811921	155,80
Sportsman 600 4x4	03-04			79-811890	191,60
Ranger 4x4 700	05-09			79-811945	206,70
Ranger 4x4 700 CREW	08-09			79-811945	206,70
Ranger 6x6 700 EFI	06-09			79-811945	206,70
Sportsman 700 4x4	02-03			79-811891	191,60
Sportsman 700 4x4 [If built before 10/02/03]	2004			79-811891	191,60
Sportsman 700 4x4 [If built after 10/02/03]	2004			79-811945	206,70
Sportsman 700 4x4	05-07			79-811945	206,70



Vanteet ja renkaat



Talvituet



Vinsit



Laukut ja tuulisuojat



Sähköosat



Jousitus ja voimansiirto



Pakoputket ja suutinsarjat



Ohjaus



Rungon osat ja peitteet



Jarrupalat ja rattaat



Moottori



Variaattorin osat



Maatalous-tarvikkeet



Kärryt ja reet



ATV



ATV



TIIVISTESARJAT JATKUU

Winderosa on tiivistesarjojen markkinajohtaja maailmassa. Varmaa laatua, valmistettu USA:ssa.



POLARIS					
Sportsman 700 EFI	05-07			79-811945	206,70
Sportsman X2 700 EFI	2008			79-811945	206,70
Ranger 4x4 800 EFI	2010			79-811945	206,70
Ranger 4x4 800 EFI CREW	2010			79-811945	206,70
RANGER 6X6 800	2010			79-811945	206,70
RANGER RZR 4 800	2010			79-811945	206,70
RANGER RZR S 800	09-10			79-811945	206,70
RZR 800	08-10			79-811945	206,70
Sportsman 800 EFI	05-10			79-811945	206,70
Sportsman 800 EFI 6x6	08-10			79-811945	206,70
Sportsman Touring 800 EFI	08-09			79-811945	206,70
Sportsman X2 800 EFI	07-09			79-811945	206,70

SUZUKI					
LT-A50	02-05	79-810850	16,30		
LT-80	87-06	79-810849	16,30		
LT-F160	91-01	79-810848	39,70		
LT-230E	87-93	79-810809	34,50		
LT-250R	87-92	79-810822	34,50		
LT-4WD 250 Quad Runner	87-98	79-810810	36,50	79-811810	94,50
LT-F250 2WD	88-01	79-810810	36,50	79-811810	94,50
LT-F250 Ozark	02-13	79-810886	36,50	79-811886	78,30
LT-F250F 4WD Quad Runner	99-02	79-810810	36,50	79-811810	94,50
LT-Z250	04-09	79-810886	36,50	79-811886	78,30
LT-F300F King Quad	99-02	79-810832	42,70	79-811832	95,50
LT-F4WDX King Quad 300	91-98	79-810832	42,70	79-811832	95,50
LT-A400 2WD King Quad	08-09	79-810846	48,70	79-811870	151,50
LT-A400 Eiger 2wd	02-07	79-810846	48,70	79-811870	151,50
LT-A400F 4WD King Quad	08-13	79-810846	48,70		
LT-A400F Eiger 4wd	02-07	79-810846	48,70	79-811870	151,50
LT-F400 2WD King Quad	08-09	79-810846	48,70	79-811846	120,90
LT-F400 Eiger 2wd	02-07	79-810846	48,70	79-811846	120,90
LT-F400F 4WD King Quad	08-12	79-810846	48,70	79-811846	120,90
LT-F400F Eiger 4wd	02-07	79-810846	48,70	79-811846	120,90
LT-Z400	03-08	79-810847	48,70	79-811847	130,10
LT-Z400	09-13	79-810847	48,70		
LT-R450	06-08			79-811916	187,10
LT-500R	88-90	79-810823	36,50	79-811823	87,50
LT-A500F Quad Master Auto	00-01	79-810828	39,70	79-811839	146,30
LT-A500F Vinson	02-07	79-810828	39,70	79-811839	146,30
LT-F500F	98-02	79-810828	39,70	79-811828	95,50
LT-F500F Vinson	03-07	79-810828	39,70	79-811828	95,50
LTV-700F Twin Peaks	04-05	79-810880	100,70	79-811880	164,70

YAMAHA					
YFM50 Raptor	04-08	79-810878	38,70		
YFM80 Badger	85-01	79-810851	38,70		
YFM80 Grizzly	05-08	79-810851	38,70		
YFM80 Raptor	02-08	79-810851	38,70		
YFA1	91-04			79-811885	78,30
YFM125 Grizzly	04-13			79-811885	78,30
YFS200 Blaster	88-06	79-810811	32,50	79-811811	69,10
YFB250 Timberwolf	92-98	79-810824	52,90	79-811899	94,50
YFB250FW Timberwolf	94-00	79-810824	52,90	79-811824	97,50
YFM250 Beartracker	99-04	79-810824	52,90	79-811899	94,50
YFM250 Big Bear	07-09	79-810824	52,90	79-811899	94,50
YFM250 Moto-4	89-91	79-810824	52,90	79-811899	94,50
YFM250B Bruin	05-06	79-810824	52,90	79-811899	94,50
YFM350 Grizzly IRS	07-11	79-810813	35,50	79-811882	100,70
YFM350 Raptor	04-13	79-810813	35,50	79-811813	100,70
YFM350 Warrior	87-04	79-810813	35,50	79-811813	100,70
YFM350BA Bruin 2WD	04-06	79-810813	35,50	79-811882	100,70

YAMAHA					
YFM350ER Moto-4	87-95	79-810898	38,70	79-811898	134,10
YFM350FA Bruin 4WD	04-06	79-810813	35,50	79-811882	100,70
YFM350FGW Grizzly 4WD	07-14	79-810813	35,50	79-811882	100,70
YFM350FW Big Bear	87-96	79-810898	38,70	79-811898	134,10
YFM350FW Big Bear	97-99	79-810813	35,50	79-811861	106,70
YFM350GW Grizzly 2WD	07-11	79-810813	35,50	79-811882	100,70
YFM350U Big Bear	96-99	79-810898	38,70	79-811898	134,10
YFM35FX Wolverine	95-05	79-810813	35,50	79-811861	106,70
YFM35X Wolverine	06-09	79-810813	35,50	79-811882	100,70
YFZ350 Banshee	87-06	79-810812	42,70	79-811812	97,50
YFM400 Big Bear 2WD	00-04	79-810813	35,50	79-811861	106,70
YFM400 Big Bear 4WD	00-06	79-810813	35,50	79-811861	106,70
YFM400 Big Bear IRS	07-12	79-810813	35,50	79-811861	106,70
YFM400 Grizzly IRS	07-08	79-810875	67,10	79-811875	137,30
YFM400 Kodiak 2WD	00-04	79-810875	67,10	79-811875	137,30
YFM400 Kodiak 4WD	93-98	79-810898	38,70	79-811898	134,10
YFM400 Kodiak 4WD	1999	79-810813	35,50	79-811861	106,70
YFM400 Kodiak 4WD	00-06	79-810875	67,10	79-811875	137,30
450 RHINO	06-09	79-810875	67,10	79-811875	137,30
YFM450 Grizzly EPS	11-14	79-810875	67,10	79-811875	137,30
YFM450 Grizzly IRS	07-14	79-810875	67,10	79-811875	137,30
YFM450 Kodiak	03-06	79-810875	67,10	79-811875	137,30
YFM45FX Wolverine 450 4X4	06-10	79-810875	67,10	79-811875	137,30
YFZ450	04-13			79-811869	128,10
YFZ450R	09-14			79-811944	129,60
YFZ450X	10-11			79-811944	129,60
YFM550 Grizzly	09-14			79-811946	163,00
YFM550 Grizzly EPS	09-14			79-811946	163,00
YFM600 Grizzly	98-02	79-810833	44,70	79-811833	144,30
660 RHINO	04-07	79-810865	80,30	79-811865	196,10
YFM660 Grizzly	02-08	79-810865	80,30	79-811865	196,10
YFM660R Raptor	01-05	79-810852	73,10	79-811852	171,70
700 RHINO FI	08-13	79-810923	98,50		
YFM700 Grizzly	07-14	79-810923	98,50		
YFM700 Grizzly EPS	08-14	79-810923	98,50		
YFM700R Raptor	06-14	79-810923	98,50		



Vanteet ja renkaat



Talvituotteet



Vinssit



Laukut ja tuulisuojat



Sähköosat



Jousitus ja voimansiirto



Pakoputket ja suutinsarjat



Ohjaus



Rungon osat ja peitteet



Jarrupalat ja rattaat



Moottori



Variaattorin osat



Maatalous-tarvikkeet



Kärryt ja reet

ATV



Vanteet ja renkaat



Talvituotteet



Vinsit



Laukut ja tuulisuojat



Sähköosat



Jousitus ja voimansiirto



Pakoputket ja suutinsarjat



Ohjaus



Rungon osat ja peitteet



Jarrupalat ja rattaat



Moottori



Variaattorin osat



Maatalous-tarvikkeet



Kärryt ja reet

ARCTIC CAT	Vuosim.	Tuotenro.	Hinta	Silmukan halk.		Pituus mm	Paksuus	
				Ylä	Ala		Ylä	Ala
DVX400	2004-09	79-09165	85,70	20	43	107	20	22
KAWASAKI								
KSF80 KFX	2003-06	79-09170	54,50	16	23	85	14	14
KSF90 KFX	2007-08	79-09170	54,50	16	23	85	14	14
KLF300 A/B BAYOU	1986-04	79-09164	69,60	18	43	117	18	22,6
KLF 300 C BAYOU 4X4	1989-05	79-09164	69,60	18	43	117	18	22,6
KEF 300 LAKOTA/SPORT	1995-03	79-09164	69,60	18	43	117	18	22,6
KVF 300/4X4 PRAIRIE	1999-02	79-09164	69,60	18	43	117	18	22,6
KFX 400	2003-08	79-09165	85,70	20	43	107	20	22
POLARIS								
250 BIG BOSS 6X6	1991-93	79-09166	73,60	23	33	120	18	18
250 R/ES TRAIL BOSS 2X4/4X4	1987-99	79-09166	73,60	23	33	120	18	18
250 TRAIL BLAZER	1990-04	79-09166	73,60	23	33	120	18	18
250 XPLOER 4X4	2000-01	79-09166	73,60	23	33	120	18	18
300 2X4/4X4	1994-95	79-09166	73,60	23	33	120	18	18
300 BIG BOSS 4X6	1989-92	79-09166	73,60	23	33	120	18	18
300 BIG BOSS 6X6	1994	79-09166	73,60	23	33	120	18	18
300 XPLOER 4X4	1996-99	79-09166	73,60	23	33	120	18	18
300 XPRESS 2X4	1996-99	79-09166	73,60	23	33	120	18	18
335 SPORTSMAN 4X4	1999-00'	79-09167	78,70	23	43	130	22	22
350 BIG BOSS 6X6	1991-93'	79-09169	72,70	23	34	130	20	20
350L SPORTSMAN	1993	79-09169	72,70	23	34	130	20	20
350L TRAILBOSS 2X4/4X4	1990-93'	79-09169	72,70	23	34	130	20	20
400 SCRAMBER	2000	79-09169	72,70	23	34	130	20	20
400L 2X4/4X4	1994-95'	79-09169	72,70	23	34	130	20	20
400L BIG BOSS 6X6	1994-97'	79-09169	72,70	23	34	130	20	20
400L SPORT	1994-99'	79-09169	72,70	23	34	130	20	20
400L SPORTSMAN 4X4	2001	79-09167	78,70	23	43	130	22	22
400L SPORTSMAN 4X4	1994-97'	79-09169	72,70	23	34	130	20	20
400L TRAIL BOSS 2X4	1994-95'	79-09169	72,70	23	34	130	20	20
400L TRAIL BOSS 4X4	1994'	79-09169	72,70	23	34	130	20	20
400L TRAIL BOSS SPORT	1994-95'	79-09169	72,70	23	34	130	20	20
400L XPLOER 4X4	1995	79-09169	72,70	23	34	130	20	20
400L XPLOER 4X4	1995-01'	79-09169	72,70	23	34	130	20	20
400L XPRESS 2X4	1995-01'	79-09169	72,70	23	34	130	20	20
425L MAGNUM 2X4/4X4/6X6	1995-98'	79-09167	78,70	23	43	130	22	22
500 BIG BOSS 6X6	1998-99'	79-09168	76,70	23	43	127,5	22	22
500 MAGNUM	1999-00'	79-09168	76,70	23	43	127,5	22	22
500 RANCHER	1998-00'	79-09168	76,70	23	43	127,5	22	22
500 SCRAMBLER	1997	79-09168	76,70	23	43	127,5	22	22
500 SPORTSMAN	1996-00'	79-09168	76,70	23	43	127,5	22	22
500 SPORTSMAN 6X6	2000	79-09168	76,70	23	43	127,5	22	22
500 XPOLRER	1997	79-09168	76,70	23	43	127,5	22	22
600 SPORTSMAN	2003-05	79-09406	86,70	20	42	132	24	24
700 MVR5 4X4	2008	79-09406	86,70	20	42	132	24	24



KIERTOKANKISARJAT JATKUU



Vanteet
renkäi



Talvituetet



Vinssi



Laukut
tuulisuoj



Sähköos



Jousitus
voimansiiri



Pakoputket
suutinsarj



Ohjat



Rungon os
ja peitte



Jarrupalat
ratta



Mootto



Variaattori
osi



Maatalou
tarvikke



Kärryt ja rei

ATV

				Silmukan halk.	Pituus	Paksuus			
POLARIS									
	700 RANGER 4X4 EFI/XP	2007-09	79-09406	86,70	20	42	132	24	24
	700 RANGER 6X6 EFI	2006-09	79-09406	86,70	20	42	132	24	24
	700 SPORTSMAN	2002-06	79-09406	86,70	20	42	132	24	24
	700 SPORTSMAN EFI	2005-07	79-09406	86,70	20	42	132	24	24
	700 SPORTSMAN MILITARY	2010-12	79-09406	86,70	20	42	132	24	24
	700 SPORTSMAN MV	2007	79-09406	86,70	20	42	132	24	24
	700 SPORTSMAN X2 EFI	2007-08	79-09406	86,70	20	42	132	24	24
	800 MVR5 4X4	2008	79-09406	86,70	20	42	132	24	24
	800 RANGER 4X4 EFI	2010-12	79-09406	86,70	20	42	132	24	24
	800 RANGER 6X6 EFI	2010-12	79-09406	86,70	20	42	132	24	24
	800 RANGER RZR "S" EFI	2009-10	79-09406	86,70	20	42	132	24	24
	800 RANGER RZR EFI	2008-10	79-09406	86,70	20	42	132	24	24
	800 RANGER XP	2005-06	79-09406	86,70	20	42	132	24	24
	800 SPORTSMAN EFI	2005-10	79-09406	86,70	20	42	132	24	24
	800 SPORTSMAN EFI 6X6	2009-10	79-09406	86,70	20	42	132	24	24
	800 SPORTSMAN HO EFI	2008-09	79-09406	86,70	20	42	132	24	24
	800 SPORTSMAN TOURING EFI	2008-09	79-09406	86,70	20	42	132	24	24
	800 SPORTSMAN X2 EFI	2007-09	79-09406	86,70	20	42	132	24	24
	ATP 500 4X4	2004-05	79-09191	104,90	23	43	127,5	22	22
	HAWKEYE 400 HO 2X4	2011-13	79-09191	104,90	23	43	127,5	22	22
	RANGER 400 4X4/HO 4X4	2010-12	79-09191	104,90	23	43	127,5	22	22
	RANGER 400 MIDSIZE	2013	79-09191	104,90	23	43	127,5	22	22
	RANGER 500 4X4 EFI	2006-07	79-09191	104,90	23	43	127,5	22	22
	SCRAMBLER 2X4 INTL	2008-09	79-09191	104,90	23	43	127,5	22	22
	SCRAMBLER 500		79-09191	104,90	23	43	127,5	22	22
	SCRAMBLER 500 4X4	2001-12	79-09191	104,90	23	43	127,5	22	22
	SPORTSMAN 400 HO 4X4	2008-13	79-09191	104,90	23	43	127,5	22	22
	SPORTSMAN 450	2006-07	79-09191	104,90	23	43	127,5	22	22
	SPORTSMAN 500	2004	79-09191	104,90	23	43	127,5	22	22
	SPORTSMAN 500 EFI TRACTOR	2009-10	79-09191	104,90	23	43	127,5	22	22
	SPORTSMAN 500 EFI/HO	2001-11	79-09191	104,90	23	43	127,5	22	22
	SPORTSMAN 500 HO	2012-13	79-09191	104,90	23	43	127,5	22	22
	SPORTSMAN FOREST 500	2011-13	79-09191	104,90	23	43	127,5	22	22
	SPORTSMAN FOREST TRACTOR 500	2011-12	79-09191	104,90	23	43	127,5	22	22
	SPORTSMAN TOURING 500 EFI	2008-09	79-09191	104,90	23	43	127,5	22	22
	SPORTSMAN TOURING 500 EFI QUAD	2008-09	79-09191	104,90	23	43	127,5	22	22
	SPORTSMAN TOURING 500 HO	2010-13	79-09191	104,90	23	43	127,5	22	22
	SPORTSMAN X2 500 EFI/EFI QUAD	2006-09	79-09191	104,90	23	43	127,5	22	22
	WORKER 500	2001	79-09191	104,90	23	43	127,5	22	22
SUZUKI									
	LT80 QUADRUNNER	1987-00	79-09170	54,50	16	23	85	14	14
	LT80 QUAD SPORT	2001-07	79-09170	54,50	16	23	85	14	14
	LT250EF	1985-86	79-09171	54,50	16	39	115,5	14	18
	LT-F 250 QUAD RUNNER	1988-02	79-09171	54,50	16	39	115,5	14	18
	LTF 250 OZARK	2002-06	79-09171	54,50	16	39	115,5	14	18
	LTF 250F QUAD RUNNER 4X4	1999-02	79-09171	54,50	16	39	115,5	14	18
	LT-4WD 4X4	1988-98	79-09171	54,50	16	39	115,5	14	18
	LTZ400	2003-09	79-09165	85,70	20	43	107	20	22
HONDA									
	TRX300	1988-00	79-09453	54,50	17	41	122	20	20
	TRX300EX	1993-06	79-09453	54,50	17	41	122	20	20
	TRX300FW	1988	79-09453	54,50	17	41	122	20	20
	TRX300FW	1990-00	79-09453	54,50	17	41	122	20	20
	TRX350FE	2000-05	79-09172	85,70	20	41	116	20	17
	TRX350FW	2000-05	79-09172	85,70	20	41	116	20	17
	TRX350TE	2000-05	79-09172	85,70	20	41	116	20	17
	TRX350TM	2000-05	79-09172	85,70	20	41	116	20	17
	TRX400 EX	1999-06	79-09250	87,80	20	43	122,6	17	21
	TRX400FW	1995-01	79-09212	52,50	19	41	122,5	20	20
	TRX450S/ES	1998-01	79-09212	52,50	19	41	122,5	20	20
YAMAHA									
	YFM 350ER MOTO 4	1987-95	79-09173	58,50	19	41	112,5	20	20
	YFM 350FW/B/H BIG BEAR	1987-99	79-09173	58,50	19	41	112,5	20	20
	YFM 350FX WOLVERINE	1995-05	79-09173	58,50	19	41	112,5	20	20
	YFM 350R RAPTOR	2005-07	79-09173	58,50	19	41	112,5	20	20
	YFM 350U BIG BEAR 2X4	1996-99	79-09173	58,50	19	41	112,5	20	20
	YFM 350X WARRIOR	1987-04	79-09173	58,50	19	41	112,5	20	20
	YFM660F	2002	79-09174	85,70	22	45	136,5	22	22
	YFM660F	2003-04	79-09174	85,70	22	45	136,5	22	22
	YFM660FAH	2005	79-09174	85,70	22	45	136,5	22	22
	YFM660FAHD	2006	79-09174	85,70	22	45	136,5	22	22
	YFM660FH	2002-04	79-09174	85,70	22	45	136,5	22	22
	YFM660FH	2004	79-09174	85,70	22	45	136,5	22	22
	YFM660FLE	2004	79-09174	85,70	22	45	136,5	22	22
	YFM660R	2002	79-09174	85,70	22	45	136,5	22	22
	YFM660R	2004-05	79-09174	85,70	22	45	136,5	22	22
	YFM660RSE	2005	79-09174	85,70	22	45	136,5	22	22
	YFM66FA	2005-06	79-09174	85,70	22	45	136,5	22	22
	YFM66FAH	2005-06	79-09174	85,70	22	45	136,5	22	22
	YFM66FAHW	2005	79-09174	85,70	22	45	136,5	22	22

ETUVAIHTEISTON ÖLJYTIIVISTEET

Polaris

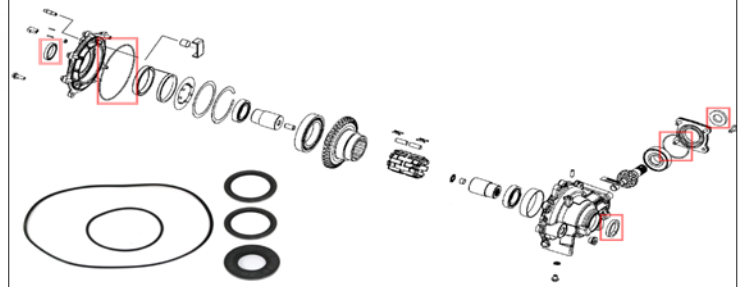
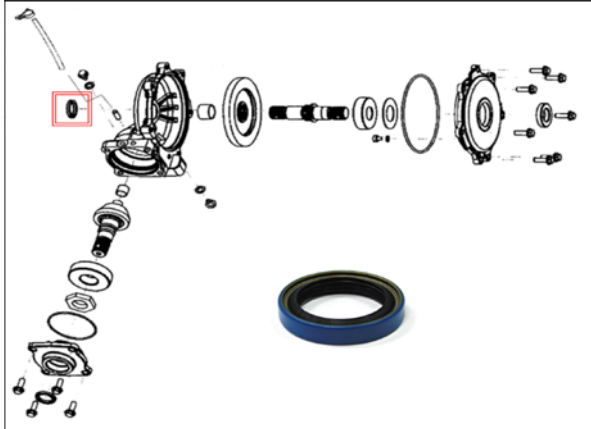

Tuoteno		Hinta
78-03818	ÖLJYTIIVISTE 34,93 x 25 x 7,93mm (Korvaa alkup. 3233785)	7,10
	2001-03	325 MAGNUM 4X4 HDS
	2001-02	MAGNUM 325 4X4
	2003-04	MAGNUM 330 4X4
	2001-02	MAGNUM 500
	2006-09	SCRAMBLER 500 4X4
	2008-09	SCRAMBLER 500 4X4 INTL
	2003-04	SPORTSMAN 600
	2002-04	SPORTSMAN 700
		SERIES 10 RANGER
		SERIES 11 RANGER

Tuoteno		Hinta
78-03826	ÖLJYTIIVISTESARJA (Korvaa alkup. 3233956)	29,30
	2004-05	ATP 500 4X4
	2004-05	ATP 330 4X4
	2005	ATP 330 4X4 QUAD
	2003-06	MAGNUM 330 4X4
	2002	MAGNUM 500
	2010	MVRS 700 4X4
	SERIES 10	RANGER
	SERIES 11	RANGER
	2004-05	RANGER 2X4,4X4,6X6
	2006-07	RANGER 500 2X4/4X4
	2006-08	RANGER 500 4X4 EFI
	SERIES 10	RANGER 500 6X6
	2006-09	RANGER 6X6 700 EFI
	2010-11	RANGER EV/INTL 4X4
	2005-06	RANGER XP 4x4 700
	2007-09	RANGER 4X4 700 EFI/XP ALL OPTIONS
	2004-05	SPORTSMAN 400
	2006	SPORTSMAN 450
	2003-05	SPORTSMAN 600
	2005-06	SPORTSMAN 800 EFI
	2005	SPORTSMAN MV 7
	2005	SPORTSMAN MV7
	SERIES 11 UTV 2X4/4X4/6X6	
	SERIES 10 UTV 4X4	

Öljynjäähdyttäjän letku Polaris- mönkijöihin

(Korvaa Alkup.nr 5412355)

Tuoteno	Hinta
78-09260	47,00
POLARIS	
2003-07	ATP 330
2003-07	TRAIL BOSS 330
2003-07	MAGNUM 330



Vanteet ja renkaat



Talvituotteet



Vinsit



Laukut ja tuulisuojat



Sähköosat



Jousitus ja voimansiirto



Pakoputket ja suutinsarjat



Ohjaus



Rungon osat ja peitteet



Jarrupalat ja rattaat



Moottori



Variaattorin osat



Maatalous-
tarvikkeet



Kärryt ja reet

ATV



KYTKINSARJAT 27-28"

Parantaa kytkimen toimintaa ja on valmiiksi asetettu uudelle välitykselle, jonka 27-28 tuumaisten renkaiden vaihto aiheuttaa. Valmistettu USA:ssa.



SPORT UTILITY



ECONOMY

ARCTIC CAT	Vuosi-malli	Sarja	Tuotenumero	Hinta
500 I Auto 4x4	2001-05	Sport utility	70-490510	256,10
500 Auto 4x4	2006-09	Sport utility	70-490502	256,10
550 H1 EFI 4x4	2009	Sport utility	70-436727	256,10
550 H1 PROWLER EFI	2009-13	Sport utility	70-436905	256,10
650 H1 4x4	2006-07	Sport utility	70-491011	256,10
650 H1 Prowler 4x4	2006-09	Sport utility	70-490303	256,10
650 V2 4x4	2004-06	Sport utility	70-490675	250,10
650 V2 4x4 for Ignition Module	2004-06	Sport utility	70-490685	250,10
700 EFI Auto 4x4	2007-08	Sport utility	70-490652	256,10
700 H1 EFI 4x4	2008-12	Sport utility	70-436408	256,10
700 Core Limited	2013-	Sport utility	70-436408	256,10
700 Prowler HDX	2012-13	Sport utility	70-437069	251,00
1000 PROWLER XTZ	2009-10	Sport utility	70-436985	256,10
Thunder Cat Auto 4x4	2008-10	Sport utility	70-436579	256,10
1000 Wildcat 4x4	2013	Sport utility	70-437147	223,00
1000 Wildcat X 4x4	2013	Sport utility	70-437140	334,00

CAN-AM	Vuosi-malli	Sarja	Tuotenumero	Hinta
400 Outlander EFI 4x4	2009-11	Sport utility	70-436513	256,10
400 Outlander 4x4	2003-08	Sport utility	70-436513	256,10
500 Outlander EFI 4x4	2009-11	Sport utility	70-436536	320,60
500 Outlander 4x4	2007-08	Sport utility	70-436536	320,60
500 Renegade EFI 4x4	2008-11	Sport utility	70-436495	320,60
650 Outlander HO EFI 4x4	2010-11	Sport utility	70-436962	298,50
650 Outlander HO EFI 4x4	2007-09	Sport utility	70-436502	298,50
800 Commander 4x4	2011-13	Sport utility	70-437132	312,00
800 Outlander R XMR 4x4	2011-	Mudder 28-29,5"	70-437023	385,20
800 Outlander R EFI Xcc 4x4	2011	Sport utility	70-437013	358,90
800 Outlander R EFI 4x4	2009-13	Sport utility	70-436524	358,90
800 Outlander HO EFI 4x4	2006-08	Sport utility	70-436524	358,90
800 Renegade 4x4	2007-11	Sport utility	70-436547	358,90
800 R Renegade EFI/EFI Xcc 4x4	2012	Sport utility	70-437081	358,90
1000 Commander 4x4	2013-	Sport utility	70-437104	358,90
1000 Commander 4x4	2011-12	Sport utility	70-437017	358,90
1000 Maverick	2013-	Sport utility	70-437125	376,00
1000 Outlander 4x4	2012-13	Sport utility	70-437055	358,90
1000 Renegade 4x4	2012	Sport utility	70-437062	358,90

HONDA	Vuosi-malli	Sarja	Tuotenumero	Hinta
TRX 350 2x4/4x4	2000-05	Economy	70-497010	65,60
TRX 350 TE/FE 2x4/4x4	2000-05	Economy	70-497010	65,60
TRX 350 TM/FM 2x4/4x4	2000-05	Economy	70-497010	65,60
TRX 420 Rancher 2x4/4x4	2007-13	Economy	70-497015	65,60
TRX 500 Foreman 4x4	2005-11	Economy	70-497050	65,60
TRX 500 Foreman 4x4	2012-13	Economy	70-437077	62,50
TRX 500 Rubicon 4x4	2001-13	Economy	70-497020	65,60

KAWASAKI	Vuosi-malli	Sarja	Tuotenumero	Hinta
650 Brute Force 4x4	2006-11	Sport utility	70-441654	320,60
650 Brute Force 4x4 for Ignition Module	2006-11	Sport utility	70-441519	320,60
750 Brute Force 4x4	2006-07	Sport utility	70-441729	320,60
750 Brute Force 4x4 for Ignition Module	2006-07	Sport utility	70-441538	320,60
750 Brute Force EFI 4x4i	2008-11	Sport utility	70-443102	333,70
750 Brute Force EFI 4x4i	2012-	Sport utility	70-443152	333,70

KYMCO	Vuosi-malli	Sarja	Tuotenumero	Hinta
500 MXU	2007-08	Sport utility	70-436802	256,10
550 UXV 4x4	2008-09	Sport utility	70-436806	256,10
700 MXU	2014-	Sport utility	70-437175	251,00

POLARIS	Vuosi-malli	Sarja	Tuotenumero	Hinta
400 Ranger	2010-	Sport utility	70-437009	297,50
400 Sportsman	2001-05	Sport utility	70-434002	248,00
450 Sportsman 4x4	2006	Sport utility	70-434018	320,60
500 Big Boss 6x6	1998-99	Sport utility	70-435001	320,60
500 Sportsman EFI 4x4	2008-09	Sport utility	70-436260	320,60
500 Sportsman EFI 4x4	2007	Sport utility	70-436075	320,60
500 Sportsman EFI 4x4	2006	Sport utility	70-430503	320,60
500 Sportsman HO Carb 4x4 (Not EBS)	2006-13	Sport utility	70-435013	320,60
500 Xplorer 4x4	1997	Sport utility	70-435001	248,00
550 Sportsman XP EFI	2011-13	Sport utility	70-437026	385,20
550 Sportsman XP	2009-10	Sport utility	70-436811	320,60
550 Sportsman X2	2010-	Sport utility	70-436811	320,60
570 RZR	2012-	Sport utility	70-437045	251,00
600 Sportsman 4x4 (EBS)	2003-05	Sport utility	70-436000	320,60
700 Ranger XP 4x4	2008-09	Sport utility	70-436655	256,10
700 Sportsman EFI 4x4	2007	Sport utility	70-435021	256,10
700 Sportsman EFI 4x4	2004-06	Sport utility	70-435025	385,20
700 Sportsman EFI 4x4	2004-06	Mudder 28-29,5"	70-423700	359,00
800 RZR 4x4	2009-11	Sport utility	70-436666	256,10
800 RZR EPS	2013-	Sport utility	70-437168	376,00
800 Sportsman EFI	2010-12	Sport utility	70-437004	256,10
800 Sportsman EFI 4x4	2008-09	Sport utility	70-436320	385,20
800 Sportsman EFI Deluxe 4x4	2007	Sport utility	70-436190	385,20
800 Sportsman EFI 4x4	2005-06	Sport utility	70-435073	385,20
850 Scrambler	2013-	Sport utility	70-437111	251,00
850 Sportsman XP HO	2012-13	Sport utility	70-437050	358,90
850 Sportsman XP EFI	2011	Sport utility	70-437029	256,10
850 Sportsman XP	2009-10	Sport utility	70-436900	385,20
900 Ranger XP	2013-	Sport utility	70-437097	251,00
900 RZR XP	2012-	Sport utility	70-437037	413,00
1000 RZR XP	2014-	Sport utility	70-437161	413,00

SUZUKI	Vuosi-malli	Sarja	Tuotenumero	Hinta
450 King Quad AXi 4x4	2008-10	Sport utility	70-493005	244,00
450 King Quad 4x4	2007-08	Sport utility	70-493005	244,00
700 King Quad 4x4	2007	Sport utility	70-495023	244,00
700 King Quad 4x4	2005-06	Sport utility	70-495025	244,00
750 King Quad AXi 4x4	2008-13	Sport utility	70-436351	244,00

YAMAHA	Vuosi-malli	Sarja	Tuotenumero	Hinta
350 Grizzly 4x4	2008-12	Sport utility	70-436554	127,50
400 Kodiak 4x4	2000-06	Sport utility	70-391005	244,00
400 Grizzly 4x4	2007-08	Sport utility	70-391005	244,00
450 Grizzly 4x4	2008-13	Sport utility	70-490704	244,00
450 Grizzly 4x4	2007	Sport utility	70-391019	244,00
450 Wolverine 4x4	2006-09	Sport utility	70-391023	244,00
550 Grizzly FI 4x4	2009-13	Sport utility	70-436633	244,00
600 Grizzly 4x4	1998-01	Sport utility	70-391020	244,00
660 Grizzly 4x4	2002-08	Sport utility	70-391040	244,00
700 Grizzly 4x4	2007-12	Sport utility	70-391077	256,10
700 Rhino	2009-13	Sport utility	70-436603	251,00
700 Viking	2014-	Sport utility	70-437154	251,00

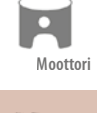



KYTKIMEN KORJAUSSARJAT



70-210145



70-210155



70-210165



70-210180



70-210185



70-213215



70-213220

POLARIS	ENSIÖ	Ovh	TOISIO	Ovh	POLARIS	ENSIÖ	Ovh	TOISIO	Ovh
Big Boss 4x6 89-92	70-210145	179,00			500 Ranger 2x4 04-09	70-210165	179,00	70-213215	69,00
250 Big Boss 6x6 91-92	70-210145	179,00			500 Ranger 4x4 04-07	70-210165	179,00	70-213215	69,00
250 Trail Blazer 2x4 96-06	70-210155	179,00	70-213215	69,00	500 Ranger 6x6 04-05	70-210165	179,00	70-213215	69,00
250 Trail Blazer 2x4 90-92	70-210145	179,00			500 Ranger EFI 4x4 06-10	70-210165	179,00	70-213215	69,00
250 Trail Boss 2x4 00-02			70-213215	69,00	500 Scrambler 2x4 01-02	70-210165	179,00	70-213215	69,00
250 Trail Boss 2x4 99	70-210155	179,00	70-213215	69,00	500 Scrambler 4x4 02-08	70-210165	179,00	70-213215	69,00
250 Trail Boss 2x4 95-98	70-210155	179,00			500 Scrambler 4x4 99-01	70-210165	179,00	70-213215	69,00
250 Trail Boss 2x4/4x4 89-92	70-210145	179,00			500 Scrambler 4x4 97-98	70-210165	179,00		
250 Xplorer 2x4 00-01			70-213215	69,00	500 Sportsman 4x4 96-98	70-210165	179,00		
250 Xplorer 4x4 00-02	70-210155	179,00			500 Sportsman DUSE (EBS) 4x4 01	70-210180	189,00	70-213220	159,00
300 Xplorer 2x4 99	70-210165	179,00	70-213215	69,00	500 Sportsman 4x4 00			70-213215	69,00
300 Xplorer 4x4 96-98	70-210165	179,00			500 Sportsman (EBS) 4x4 99-00	70-210180	189,00	70-213220	159,00
300 Xpress 2x4 99	70-210165	179,00	70-213215	69,00	500 Sportsman (EBS) 4x4 98	70-210180	189,00		
300 Xpress 2x4 96-98	70-210165	179,00			500 Sportsman EFI 4x4 08-09	70-210185	229,00		
325 Magnum 2x4 01-02	70-210165	179,00	70-213215	69,00	500 Sportsman EFI 4x4 07	70-210165	179,00	70-213200	199,00
325 Magnum 2x4 00	70-210155	179,00	70-213215	69,00	500 Sportsman EFI 4x4 06	70-210185	219,00	70-213200	199,00
325 Magnum 4x4 01-02	70-210165	179,00	70-213215	69,00	500 Sportsman EFI Touring 4x4 08	70-210185	219,00		
325 Magnum 4x4 00	70-210155	179,00	70-213215	69,00	500 Sportsman HO Touring 10-12	70-210185	219,00		
325 Magnum (EBS) 4x4 00-01			70-213220	159,00	500 Sportsman HO 4x4 11-12	70-210165	179,00	70-213215	69,00
325 Trail Boss 2x4 02	70-210165	179,00			500 Sportsman HO 4x4 06/08	70-210165	179,00	70-213215	69,00
325 Trail Boss 2x4 01	70-210165	179,00	70-213215	69,00	500 Sportsman HO 4x4 05	70-210180	189,00	70-213200	199,00
325 Trail Boss 2x4 00	70-210165	179,00			500 Sportsman HO (EBS) 4x4 01-04	70-210180	189,00	70-213220	
330 ATP 4x4 04-05	70-210165	179,00	70-213215	69,00	500 Sportsman 6x6 01-08	70-210165	179,00	70-213215	69,00
330 Magnum 2x4 03-05	70-210165	179,00	70-213215	69,00	500 Sportsman 6x6 00	70-210165	179,00		
330 Magnum 4x4 04-06	70-210165	179,00	70-213215	69,00	500 Sportsman EFI X2 4x4 07-08	70-210185	219,00		
330 Magnum 4x4 03	70-210165	179,00	70-213220	159,00	500 Sportsman X2 4x4 06	70-210185	219,00	70-213200	199,00
330 Magnum (EBS) 4x4 04	70-210165	179,00	70-213200	199,00	500 Worker 4x4 99/01	70-210165	179,00		
330 Trail Blazer 2x4 08	70-210165	179,00	70-213215	69,00	500 Xplorer 4x4 97	70-210165	179,00		
330 Trail Boss 2x4 03-08	70-210165	179,00	70-213215	69,00	550 Sportsman XP 09-10	70-210155	179,00	70-213215	69,00
335 Sportsman 4x4 00			70-213215	69,00	600 Sportsman 4x4 05	70-210175	219,00	70-213200	199,00
335 Sportsman 4x4 99	70-210155	179,00	70-213215	69,00	600 Sportsman 4x4 04 (after 7/1/03)	70-210175	219,00	70-213200	199,00
335 Worker 4x4 99			70-213215	69,00	600 Sportsman 4x4 04 (before 7/1/03)	70-210175	219,00	70-213220	159,00
350 Trail Boss 2x4/4x4 90-92	70-210155	179,00			600 Sportsman 4x4 03	70-210175	219,00	70-213220	159,00
400 2x4 95	70-210165	179,00			700 MV7 4x4 05	70-210175	219,00		
400 Big Boss 6x6 95-97	70-210165	179,00			700 Ranger Crew 4x4 08	70-210185	219,00		
400 Scrambler 2x4 01-02			70-213215	69,00	700 Ranger EFI 6x6 08	70-210185	219,00		
400 Scrambler 2x4 00	70-210165	179,00	70-213215	69,00	700 Ranger EFI 6x6 06-07	70-210910	214,00		
400 Scrambler 4x4 02	70-210165	179,00	70-213215	69,00	700 Ranger XP 4x4 08	70-210185	219,00		
400 Scrambler 4x4 01			70-213215	69,00	700 Ranger XP 4x4 05-07	70-210910	214,00		
400 Scrambler 4x4 00	70-210165	179,00	70-213215	69,00	700 Sportsman 4x4 06	70-210185	219,00		
400 Scrambler 4x4 95-99	70-210165	179,00			700 Sportsman 4x4 05	70-210175	219,00		
400 Sport 2x4 99	70-210165	179,00	70-213215	69,00	700 Sportsman 4x4 04 (after 7/1/03)	70-210175	219,00	70-213200	159,00
400 Sport 2x4 96-98	70-210165	179,00			700 Sportsman 4x4 04 (before 7/1/03)	70-210175	219,00	70-213220	159,00
400 Sport 2x4 94-95	70-210155	179,00			700 Sportsman 4x4 02-03	70-210175	219,00	70-213220	159,00
400 Sportsman HO 4x4 11-12	70-210165	179,00	70-213215	69,00	700 Sportsman EFI 4x4 07	70-210910	214,00		
400 Sportsman 4x4 01-05	70-210165	179,00	70-213215	69,00	700 Sportsman EFI 4x4 06	70-210185	219,00		
400 Sportsman 4x4 95-96	70-210165	179,00			700 Sportsman EFI 4x4 04-05	70-210175	219,00		
400 Trail Blazer 2x4 03	70-210165	179,00	70-213215	69,00	700 Sportsman EFI X2 4x4 08	70-210185	219,00		
400 Xplorer 4x4 99-02	70-210165	179,00	70-213215	69,00	800 Sportsman EFI HO 4x4 08	70-210185	219,00		
400 Xplorer 4x4 95-98	70-210165	179,00			800 Sportsman EFI 4x4 07	70-210910	214,00		
400 Xpress 2x4 96-97	70-210165	179,00			800 Sportsman EFI 4x4 05-06	70-210185	219,00		
425 Magnum 2x4 96-98	70-210165	179,00			800 Sportsman EFI Touring 4x4 08-09	70-210185	219,00		
425 Magnum 2x4 95	70-210155	179,00			800 Sportsman EFI X2 4x4 07	70-210185	219,00		
425 Magnum 4x4 96-97	70-210165	179,00			850 Sportman XP 4x4 09-10	70-210185	219,00		
425 Magnum 6x6 96-97	70-210165	179,00			Diesel (EBS) 4x4 99-01	70-210180	199,00	70-213220	159,00
450 Sportsman 4x4 06-07	70-210165	179,00	70-213215	69,00	Ranger 6x6 99	70-210165	179,00	70-213215	69,00
500 ATP 4x4 (after 7/1/03) 04-05	70-210180	189,00	70-213200	199,00					
500 ATP 4x4 (before 7/1/03) 04	70-210180	189,00	70-213220	159,00					
500 Big Boss 6x6 99	70-210165	179,00	70-213215	69,00					
500 Big Boss 6x6 98	70-210165	179,00							
500 Magnum (EBS) 4x4 99-02	70-210180	189,00	70-213220	159,00					
500 Magnum RMK (EBS) 4x4 02	70-210180	189,00	70-213220	159,00					
500 Magnum 4x4 00			70-213215	69,00					



Vanteet ja renkaat



Talvituotteet



Vinsit



Laukut ja tuulisuojat



Sähköosat



Jousitus ja voimansiirto



Pakoputket ja suutinsarjat



Ohjaukset



Runnon osat ja peitteet



Jarrupalat ja rattaat



Moottori



Variaattorin osat



Maatalous-tarvikkeet



Kärryt ja reet



ATV



ATV



EPI RULLASARJAT

Variaattorin rullasarjat. Pakkauskoko: 8 kpl / pkt.

ARCTIC CAT

500 Auto, 550 H1, H1 Prowler, 650 H1, H1 Prowler, 700 EFI, H1, H1 Prowler, 1000 Prowler, Thunder Cat 08, 1000 Thunder Cat H2

22 g	70-245022	74,00
20 g	70-245020	74,00
18 g	70-245018	74,00
16 g	70-245016	74,00
Muovirullat	70-245000	61,50



SUZUKI

Fits: 450, 500, 700,750 King Quad; 500 Vinson (Auto)

22 g	70-245022	74,00
20 g	70-245020	74,00
18 g	70-245018	74,00
16 g	70-245016	74,00
Muovirullat	70-245000	61,50



YAMAHA

350 Bruin / 450 Wolverine /Kodiak, Grizzly, Rhino

32 g	70-241032	77,20
30 g	70-241030	77,20
28 g	70-241028	77,20
26 g	70-241026	77,20
24 g	70-241024	77,20
22 g	70-241022	77,20
20 g	70-241020	77,20
18 g	70-241018	77,20
16 g	70-241016	77,20
14 g	70-241014	77,20
12 g	70-241012	77,20
10 g	70-241010	77,20



Vanteet ja renkaat



Talvituotteet



Vinssit



Laukut ja tuulisuojat



Sähköosat



Jousitus ja voimansiirto



Pakoputket ja suutinsarjat



Ohjaus



Rungon osat ja peitteet



Jarrupalat ja rattaat



Moottori



Variaattorin osat



Maatalous-tarvikkeet



Kärryt ja reet



ATV



ATV



ATV



ATV



ATV

KYTKINLEVYT



ProX kytkinlevysrj.

- Sis. kaikki massalevyt
- Pääosin valmistetaan Japanissa

ProX kytkimen välilevysrj.

- Sarja sisältää kaikki joko alum. tai teräsvälilevyt
- Pääosin valmistetaan Japanissa



ProX kytkimen jousisarjat

- Sarja sis. kaikki jouset
- Valmistettu parhaista saatavilla olevista materiaaleista
- 10% jäykemmät kuin OEM

HUOM! Punaisella merkityt eivät ole varastotuotteita. Toimitusaika on n. 1-2 viikkoa.

HONDA	Vuosi	Kytkinlevysrj.	Ovh	Välilevyt	Ovh	Jousisarja	Ovh
TRX 400 EX	1999-2008	400-16-S14017	88,00			400-17-CS14009	22,00
TRX 400 X	2009-2014	400-16-S14017	88,00			400-17-CS14009	22,00
TRX 450 R	2004-2014	400-16-S14022	100,00	400-16-S14016	76,00	400-17-CS13006	26,00
TRX 700 XX	2008-2011	400-16-S14022	100,00			400-17-CS13006	26,00

KAWASAKI	Vuosi	Kytkinlevysrj.	Ovh	Välilevyt	Ovh	Jousisarja	Ovh
KFX 400	2003-2004	400-16-S34015	112,50			400-17-CS44019	26,00
KFX 450 R	2008-2014	400-16-S44039	99,50	400-16-S34016	43,00	400-17-CS44020	22,00

KTM	Vuosi	Kytkinlevysrj.	Ovh	Välilevyt	Ovh	Jousisarja	Ovh
450 XC ATV	2008-2009	400-16-S54007	80,00	400-16-S54010	31,00	400-17-CS65041	26,00
450 SX ATV	2009-2010	400-16-S54015	176,50	400-16-S54006	31,00	400-17-CS64042	26,00
505 SX ATV	2009-2012	400-16-S54015	176,50	400-16-S54006	31,00	400-17-CS64042	26,00
525 XC ATV	2008-2012	400-16-S54007	80,00	400-16-S54010	31,00	400-17-CS65041	26,00

SUZUKI	Vuosi	Kytkinlevysrj.	Ovh	Välilevyt	Ovh	Jousisarja	Ovh
LT-Z 400	2003-2004	400-16-S34015	112,50			400-17-CS44019	26,00
LT-R 450	2006-2011	400-16-S34021	123,00	400-16-S34018	53,50	400-17-CS33025	26,00

YAMAHA	Vuosi	Kytkinlevysrj.	Ovh	Välilevyt	Ovh	Jousisarja	Ovh
YFZ 450	2007	400-16-S24031	73,50	400-16-S23016	34,00	400-17-CS24039	26,00
YFZ 450	2008-2009	400-16-S24052	104,00	400-16-S23016	34,00	400-17-CS24039	26,00
YFZ 450 R	2009-2013	400-16-S24056	102,50	400-16-S23016	34,00	400-17-CS24039	26,00
YFM 660 R Raptor	2001-2005	400-16-S26029	96,00			400-17-CS22031	22,00
YFM 700 R Raptor	2006-2014	400-16-S26030	96,50	400-16-S23016	34,00	400-17-CS24036	26,00

VARIAATTORI-SUOJAN TIIVISTEET



uutuus!

Variattori suojan tiiviste Polaris 1,250 x 10mm

Length 1,250 mm, T 10 mm (+/-0.5 mm)

Tuoteno	Hinta
79-03693	9,50

uutuus!

Variattori suojan tiiviste Polaris 1380 x 10mm

O.D. 427 mm, T 7.8 mm, H 10 mm, overall length 1,380 mm (+/-3mm)

Tuoteno	Hinta
79-03694	9,50

KYTKINOSAT MOOTTORIIN

HINSON

CLUTCH COMPONENTS

uutuus!

Hinson valmistaa parhaat saatavilla olevat kytkinosat ATV:hen, crossipyöriin ja sporttipyöriin. Osilla on saavutettu 21 vuoden aikana satoja kansallisia ja MM-tittleitä. Huom! Osa tuotteista toimitusmyyntinä. Toimitusaika n. 2 viikkoa.

Reaaliaikaisen saatavuustilanteen näet osoitteesta www.duell.fi

CAN-AM	Vuosi	Kytinkori	Sisänapa	Painelevy	Sisänapa+p.Levy	Kytinkoppa	Kytinkevysrj.	Btl luistokytkin
DS450	08-14	450-0107-00401					450-1807-00101*	
* Voidaan käyttää vain yhdessä 450-0107-00401 kanssa								
HONDA	Vuosi	Kytinkori	Sisänapa	Painelevy	Sisänapa+p.Levy	Kytinkoppa	Kytinkevysrj.	Btl luistokytkin
TRX400X	09-14	450-0101-00501						
TRX450R	04-14	450-0101-01901	450-0301-00401	450-0201-00601		450-0501-00701	450-1001-00401	450-0706-00101
kAWASAKI	Vuosi	Kytinkori	Sisänapa	Painelevy	Sisänapa+p.Levy	Kytinkoppa	Kytinkevysrj.	Btl luistokytkin
KFX450R	08-14	450-0102-01501			450-0402-00101	450-0502-00501	450-1002-00301	450-0702-00401
sUZUKI	Vuosi	Kytinkori	Sisänapa	Painelevy	Sisänapa+p.Levy	Kytinkoppa	Kytinkevysrj.	Btl luistokytkin
LT-R450	08-11	450-0103-01001			450-0403-00201	450-0503-00301	450-1003-00101	450-0703-00801
yAMAHA	Vuosi	Kytinkori	Sisänapa	Painelevy	Sisänapa+p.Levy	Kytinkoppa	Kytinkevysrj.	Btl luistokytkin
YFZ450	12-15	450-0104-02201	450-0304-00701	450-0204-00601		450-0504-00401	450-1004-00601	450-0704-01301
YFM700R	06-14	450-0104-02201		450-0204-00901		450-1004-00601		
RAPTOR								

Vihreällä merkityt ovat varastotavaraa muissa toim.aika 2-4vk

Tuotenumero:	Ovh.
450-0101-00501	304,00
450-0101-01901	304,00
450-0102-01501	304,00
450-0103-01001	304,00
450-0104-02201	304,00
450-0107-00401	449,00
450-0201-00601	231,00
450-0204-00601	231,00
450-0204-00901	231,00
450-0301-00401	384,00
450-0304-00701	384,00
450-0402-00101	616,00
450-0403-00201	616,00
450-0501-00701	178,00
450-0502-00501	192,00
450-0503-00301	192,00
450-0504-00401	192,00
450-0702-00401	1199,00
450-0703-00801	1199,00
450-0704-01301	1199,00
450-0706-00101	1199,00
450-1001-00401	231,00
450-1002-00301	231,00
450-1003-00101	231,00
450-1004-00601	231,00
450-1807-00101	145,00



Vanteet ja renkaat



Talvituotteet



Vinsit



Laukut ja tuulisuojat



Sähköosat



Jousitus ja voimansiirto



Pakoputket ja suutinsarjat



Ohjauk



Rungon osat ja peitteet



Jarrupalat ja rattaat



Moottori



Variaattorin osat



Maatalous-tarvikkeet



Kärryt ja reet

ATV





EPI KYTKIMEN JOUSET

Hinta: 28,80



ENSIÖKYTKIMEN JOUSET

Can-Am

800,1000 COMMANDER
400,500,650,800 OUTLANDER
650 QUEST
500,800 RENEGADE

Tuotenumero	Väri	2-1/4" Load	1-1/4" Load
70-100020	LILA	132 lbs	182 lbs
70-100021	KELTAINEN	105 lbs	145 lbs
70-100022	VALKOINEN	91 lbs	155 lbs
70-100023	ORANSSI	87 lbs	140 lbs
70-100024	PUNAINEN	54 lbs	140 lbs
70-100025	KULTA	47 lbs	135 lbs
70-100026	VIHREÄ	72 lbs	145 lbs
70-100027	HOPEA	71 lbs	155 lbs

Polaris

Kaikki mallit.

Tuotenumero	Väri	2-1/4" Load	1-1/4" Load
70-100030	LILA	132 lbs	182 lbs
70-100031	KELTAINEN	105 lbs	145 lbs
70-100032	VALKOINEN	91 lbs	155 lbs
70-100033	ORANSSI	87 lbs	140 lbs
70-100034	PUNAINEN	54 lbs	140 lbs
70-100035	KULTA	47 lbs	135 lbs
70-100036	VIHREÄ	72 lbs	145 lbs
70-100037	HOPEA	71 lbs	155 lbs

TOISIÖKYTKIMEN JOUSET

Arctic Cat

500 Auto / 500 I Auto / 500 I TRX / TBX / 700 EFI AUTO

Tuotenumero	Väri	3 1/2" Load	2 1/4" Load
70-100016	VIHREÄ	50 kg	76 kg
70-100011	KELTAINEN	44.9 kg	66.3 kg

550 H1/H1 Prowler, 650 H1 (except 05)/650 H1 Prowler, 700 H1/H1 Prowler, 1000 Prowler/Thunder Cat/1000 Thunder Cat H2

Tuotenumero	Väri	3 1/2" Load	2 1/4" Load
70-100013	VALKOINEN	90 kg	117 kg
70-100015	PUNAINEN	81.5 kg	104.3 kg

Can-Am

800,1000 COMMANDER
400,500,650,800 OUTLANDER
650 QUEST
500,800 RENEGADE

Tuotenumero	Väri	2-1/4" Load	1-1/4" Load
70-100123	ORANSSI	175 lbs	240 lbs
70-100124	PUNAINEN	155 lbs	215 lbs
70-100128	SININEN	75 lbs	91 lbs

Suzuki

400 EIGER
450 KING QUAD
500 KING QUAD

Tuotenumero	Väri	2-1/4" Load	1-1/4" Load
70-100012	VALKOINEN	54.0 kg	69.9 kg

KING QUAD 700
KING QUAD 750

Tuotenumero	Väri	2-1/4" Load	1-1/4" Load
70-100011	KELTAINEN	44.9 kg	66.3 kg
70-100016	VIHREÄ	50 kg	76 kg

Yamaha

uutuus!

550,700 GRIZZLY
450 KODIAK,WOLVERINE
400 KODIAK

Tuotenumero	Väri	3" Load	1 3/4" Load
70-100340	Valkoinen	97,6 kg	158,9 kg
70-100345	Kulta	90,8 kg	149,8 kg
70-100343	Oranssi	86,3 kg	140,7 kg

350 Bruin,Grizzly

Tuotenumero	Väri	3" Load	1 3/4" Load
70-100346	Vihreä	61,3 kg	106,7 kg

Polaris

500 SPORTSMAN 08-
800 SPORTSMAN 07-
550 SPORTSMAN 09-
800 RZR 08-11
700 SPORTSMAN 07-
850 SPORTSMAN XP 2009-

Tuotenumero	Väri	2-1/4"	1-1/4"Load
70-100230	LILA	150 lbs	260 lbs
70-100232	VALKOINEN	95 lbs	170 lbs
70-100233	ORANSSI	238 lbs	358 lbs
70-100234	PUNAINEN	196 lbs	286 lbs
70-100235	KULTA	252 lbs	382 lbs
70-100236	VIHREÄ	120 lbs	225 lbs
70-100237	HOPEA	125 lbs	230 lbs

EBS kytkimellä

Tuotenumero	Väri	2-1/4"	1-1/4"Load
70-100131	KELTAINEN	271 lbs	382 lbs
70-100134	PUNAINEN	237 lbs	339 lbs
70-100136	VIHREÄ	200 lbs	325 lbs



Vanteet ja renkaat



Talvituotteet



Vinssit



Laukut ja tuulisuojat



Sähköosat



Jousitus ja voimansiirto



Pakoputket ja suutinsarjat



Ohjaus



Rungon osat ja peitteet



Jarrupalat ja rattaat



Moottori



Variaattorin osat



Maatalous-tarvikkeet



Kärryt ja reet

ATV



VARIATTORIHINNAT JATKUU



ATV



BOMBARDIER / CAN-AM	VM.	OEM	Tuoteno.
RENEGADE 500 EFI	2012	715-000-302	90-UA446
RENEGADE 800R EFI	2012	715-000-302	90-UA446
RENEGADE 800R EFI XXC	2012	715-000-302	90-UA446
RENEGADE 1000 EFI	2012	715-000-302	90-UA446
RENEGADE 1000 EFI XXC	2012	715-000-302	90-UA446
COMMANDER 1000	2011	715-000-302	90-UA446
COMMANDER 800	2011	715-000-302	90-UA446
OUTLANDER 400	2011	715-900-024	90-UA435
OUTLANDER 500	2011	715-000-302	90-UA446
OUTLANDER 650	2011	715-000-302	90-UA446
OUTLANDER 800R	2011	715-000-302	90-UA446
OUTLANDER 800R XMR	2011	715-000-302	90-UA446
OUTLANDER 800R XXC	2011	715-000-302	90-UA446
OUTLANDER MAX 400	2011	715-900-024	90-UA435
OUTLANDER MAX 500	2011	715-000-302	90-UA446
OUTLANDER MAX 650	2011	715-000-302	90-UA446
OUTLANDER MAX 800R	2011	715-000-302	90-UA446
OUTLANDER MAX 800R EFI	2011	715-000-302	90-UA446
OUTLANDER MAX 800R EFI LTD	2011	715-000-302	90-UA446
OUTLANDER MAX 800R LTD	2011	715-000-302	90-UA446
RENEGADE 500	2011	715-000-302	90-UA446
RENEGADE 800R	2011	715-000-302	90-UA446
RENEGADE 800R XXC	2011	715-000-302	90-UA446
OUTLANDER 400 EFI	2010	715-900-024	90-UA435
OUTLANDER 500 EFI	2010	715-000-302	90-UA446
OUTLANDER 650 EFI	2010	715-000-302	90-UA446
OUTLANDER 800R EFI	2010	715-000-302	90-UA446
OUTLANDER MAX 400 EFI	2010	715-900-024	90-UA435
OUTLANDER MAX 500 EFI	2010	715-000-302	90-UA446
OUTLANDER MAX 500 EFI LTD	2010	715-000-302	90-UA446
OUTLANDER MAX 650 EFI	2010	715-000-302	90-UA446
OUTLANDER MAX 800R EFI	2010	715-000-302	90-UA446
OUTLANDER MAX 800R EFI LTD	2010	715-000-302	90-UA446
RENEGADE 500 EFI	2010	715-000-302	90-UA446
RENEGADE 800R EFI	2010	715-000-302	90-UA446
OUTLANDER 400 EFI	2009	715-900-024	90-UA435
OUTLANDER MAX 400 EFI	2009	715-900-024	90-UA435
OUTLANDER 500 EFI	2009	715-000-302	90-UA446
OUTLANDER MAX 500 EFI XT	2009	715-000-302	90-UA446
OUTLANDER 650 EFI	2009	715-000-302	90-UA446
OUTLANDER MAX 650 EFI XT	2009	715-000-302	90-UA446
OUTLANDER 800R EFI	2009	715-000-302	90-UA446
OUTLANDER MAX 800R EFI XT	2009	715-000-302	90-UA446
RENEGADE 500 EFI	2009	715-000-302	90-UA446
RENEGADE 800R EFI X	2009	715-000-302	90-UA446
OUTLANDER 400 EFI	2008	715900024	90-UA435
OUTLANDER 400 MAX EFI	2008	715900024	90-UA435
OUTLANDER 500 STD	2008	715900030	90-UA419
OUTLANDER 500 XT	2008	715900030	90-UA419
OUTLANDER 500 MAX XT	2008	715900030	90-UA419
OUTLANDER 650 STD	2008	715900030	90-UA419
OUTLANDER 650 XT	2008	715900030	90-UA419
OUTLANDER 650 MAX XT	2008	715900030	90-UA419
OUTLANDER 800 STD	2008	715900030	90-UA419
OUTLANDER 800 XT	2008	715900030	90-UA419
OUTLANDER 800 MAX XT	2008	715900030	90-UA419
RENEGADE 500	2008	715900030	90-UA419
RENEGADE 800	2008	715900030	90-UA419
RENEGADE X 800	2008	715900030	90-UA419
OUTLANDER 400 STD 4X4 & XT	2007	715-900-024	90-UA435
OUTLANDER 500 STD 4X4 & XT	2007	715-900-030	90-UA419
OUTLANDER 650 STD 4X4 & XT	2007	715-900-030	90-UA419
OUTLANDER 800 STD 4X4 & XT	2007	715-900-030	90-UA419
OUTLANDER MAX 400 STD 4X4 & XT	2007	715-900-024	90-UA435
OUTLANDER MAX 500 STD 4X4 & XT	2007	715-900-030	90-UA419
OUTLANDER MAX 650 STD 4X4 & XT	2007	715-900-030	90-UA419
OUTLANDER MAX 800 LTD 4X4	2007	715-900-030	90-UA419
RENEGADE 800 EFI	2007	715-900-030	90-UA419
OUTLANDER 800 H.O. EFI 4X4	2006	715-900-030	90-UA419
OUTLANDER 650 H.O. EFI	2006	715-900-030	90-UA419
OUTLANDER 400 H.O.	2006	715-900-024	90-UA435
DS50	2006	A23100-117-000	90-UA436

BOMBARDIER / CAN-AM	VM.	OEM	Tuoteno.
DS50	2006	A23100-117-000	90-UA436
OUTLANDER 330 H.O. 2X4	2005	715-900-024	90-UA435
OUTLANDER 330 H.O. 4X4	2005	715-900-024	90-UA435
OUTLANDER 400 H.O. 4X4	2005	715-900-024	90-UA435
OUTLANDER MAX 400 H.O.	2005	715-900-024	90-UA435
TRAXTER 500 AUTO CVT	2005	715-900-024	90-UA435
TRAXTER 650 AUTO CVT	2005	715-900-023	90-UA420
TRAXTER MAX 650 AUTO	2005	715-900-023	90-UA420
DS90 2-STROKE	2005	A23100-117-000	90-UA436
DS50 2-STROKE	2005	A23100-117-000	90-UA436
DS50 2 STROKE	2004	A23100-117-000	90-UA436
DS90 2 STROKE	2004	A23100-117-000	90-UA436
OUTLANDER 330 H.O.	2004	715-900-024	90-UA435
OUTLANDER 330 H.O.	2004	715-900-024	90-UA435
OUTLANDER 400 H.O.	2004	715-900-024	90-UA435
OUTLANDER MAX 400 H.O.	2004	715-900-024	90-UA435
TRAXTER 500 AUTO CVT	2004	715-900-023	90-UA420
TRAXTER 650 AUTO CVT	2004	715-900-023	90-UA420
TRAXTER MAX 650 AUTO CVT	2004	715-900-023	90-UA420
DS50	2003	A23100-117-000	90-UA436
OUTLANDER 400	2003	715-900-024	90-UA435
QUEST 500 2X4	2003	715-900-023	90-UA420
QUEST 500 4X4	2003	715-900-023	90-UA420
QUEST 650	2003	715-900-023	90-UA420
QUEST 650 XT	2003	715-900-023	90-UA420
RALLY 200	2003	715-900-023	90-UA420
HISUN	VM.	OEM	Tuoteno.
800 UTV		25300-010-000	90-UA446
KAWASAKI	VM.	OEM	Tuoteno.
BRUTE FORCE 300	2014	59011-Y003	90-UA452
BRUTE FORCE 750 4X4i	2014	59011-0019	90-UA450
BRUTE FORCE 750 4X4i EPS	2014	59011-0019	90-UA450
KFX 50	2014	59011-Y001	90-UA462
KFX 90	2014	59011-Y002	90-UA415
TERYX	2014	59011-0019	90-UA450
TERYX LE	2014	59011-0019	90-UA450
TERYX 750 FI 4X4 SPORT	2014	59011-0019	90-UA450
BRUTE FORCE 300	2013	59011-Y003	90-UA452
BRUTE FORCE 650 4X4	2013	59011-0003	90-UA450
BRUTE FORCE 650 4X4i	2013	59011-0003	90-UA450
BRUTE FORCE 750 4X4i	2013	59011-0019	90-UA450
BRUTE FORCE 750 4X4i EPS	2013	59011-0019	90-UA450
KFX 50	2013	59011-Y001	90-UA462
KFX 90	2013	59011-Y002	90-UA415
PRAIRIE 360 4X4	2013	59011-0003	90-UA450
TERYX 750 FI 4X4	2013	59011-0019	90-UA450
TERYX 750 FI 4X4 LE	2013	59011-0019	90-UA450
TERYX 750 FI 4X4 SPORT	2013	59011-0019	90-UA450
TERYX4 750 4X4 EPS LE	2013	59011-0031	90-UA458
TERYX4 750 4X4 EPS	2013	59011-0031	90-UA458
BRUTE FORCE 650 4X4	2012	59011-0003	90-UA450
BRUTE FORCE 650 4X4i	2012	59011-0003	90-UA450
BRUTE FORCE 750 4X4i	2012	59011-0019	90-UA450
BRUTE FORCE 750 4X4i EPS	2012	59011-0019	90-UA450
KFX 90	2012	59011-Y002	90-UA415
PRAIRIE 360 4X4	2012	59011-0003	90-UA450
PRAIRIE 360 4X4 HD	2012	59011-0003	90-UA450
TERYX 750 4X4	2012	59011-0019	90-UA450
TERYX 750 4X4 EPS	2012	59011-0019	90-UA450
TERYX 750 FI 4X4 LE	2012	59011-0019	90-UA450
TERYX 750 FI 4X4 SPORT	2012	59011-0019	90-UA450
BRUTE FORCE 650 4X4	2011	59011-0003	90-UA450
BRUTE FORCE 650 4X4i	2011	59011-0003	90-UA450
BRUTE FORCE 750 4X4i	2011	59011-0003	90-UA450
PRAIRIE 360 4X4	2011	59011-0003	90-UA450
PRAIRIE 360 4X4 HD	2011	59011-0003	90-UA450
TERYX 750 4X4	2011	59011-0019	90-UA450
TERYX 750 4X4 LE	2011	59011-0019	90-UA450
TERYX 750 FI 4X4 LE	2011	59011-0019	90-UA450
TERYX 750 FI 4X4 SPORT	2011	59011-0019	90-UA450
BRUTE FORCE 650 4X4i	2010	59011-0003	90-UA450
BRUTE FORCE 650 4X4i HD	2010	59011-0003	90-UA450
BRUTE FORCE 750 4X4i	2010	59011-0003	90-UA450

Vanteeet ja renkaat

Talvutuotteet

Vinsit

Laukut ja tuulisuojat

Sähköosat

Jousitus ja voimansiirto

Pakoputket ja suutinsarjat

Ohjauksen osat

Runگون osat ja peitteet

Jarrupalat ja rattaat

Moottori

Variaattorin osat

Maatalous-tarvikkeet

Kärryt ja reet



VARIATTORIIHNNAT JATKUU



KAWASAKI	VM.	OEM	Tuotenro.
BRUTE FORCE 750 4X4i HD	2010	59011-0003	90-UA450
KFX 700	2010	59011-0003	90-UA450
PRAIRIE 360	2010	59011-0003	90-UA450
PRAIRIE 360 4X4 HD	2010	59011-0003	90-UA450
TERYX 750 4X4	2010	59011-0019	90-UA450
TERYX 750 4X4 LE	2010	59011-0019	90-UA450
TERYX 750 FI 4X4 LE	2010	59011-0019	90-UA450
TERYX 750 FI 4X4 SPORT	2010	59011-0019	90-UA450
BRUTE FORCE 650	2009	59011-0003	90-UA450
BRUTE FORCE 650 4X4i	2009	59011-0003	90-UA450
BRUTE FORCE 650 4X4i HD	2009	59011-0003	90-UA450
BRUTE FORCE 750 4X4i	2009	59011-0003	90-UA450
BRUTE FORCE 750 4X4i HD	2009	59011-0003	90-UA450
KFX 700	2009	59011-0003	90-UA450
PRAIRIE 360	2009	59011-0003	90-UA450
PRAIRIE 360 4X4 HD	2009	59011-0003	90-UA450
TERYX 750 (All Versions)	2009	59011-0019	90-UA450
BRUTE FORCE 650 4X4	2008	59011-0003	90-UA450
BRUTE FORCE 650 4X4i	2008	59011-0003	90-UA450
BRUTE FORCE 750 4X4	2008	59011-0003	90-UA450
BRUTE FORCE 750 4X4i	2008	59011-0003	90-UA450
KFX 700	2008	59011-0003	90-UA450
PRAIRIE 360	2008	59011-0003	90-UA450
PRAIRIE 360 4X4	2008	59011-0003	90-UA450
TERYX 750	2008	59011-0019	90-UA450
KFX 700	2007	59011-0003	90-UA450
PRAIRIE 360 4X4	2007	59011-0003	90-UA450
PRAIRIE 360	2007	59011-0003	90-UA450
BRUTE FORCE 650 4X4	2007	59011-0003	90-UA450
BRUTE FORCE 750 4X4	2007	59011-0003	90-UA450
BRUTE FORCE 650 4X4	2006	59011-0003	90-UA450
BRUTE FORCE 750 4X4	2006	59011-0003	90-UA450
KFX 700	2006	59011-0003	90-UA450
KFX 80	2006	590115-003	90-UA421
PRAIRIE 360	2006	59011-0003	90-UA450
PRAIRIE 360 4X4	2006	59011-0003	90-UA450
PRAIRIE 700 4X4	2006	59011-0003	90-UA450
BRUTE FORCE 750 4X4	2005	59011-0003	90-UA450
BRUTE FORCE 650 4X4	2005	59011-0003	90-UA450
KFX 700	2005	59011-0003	90-UA450
KFX 80	2005	590115-003	90-UA421
PRAIRIE 360	2005	59011-0003	90-UA450
PRAIRIE 700 4X4	2005	59011-0003	90-UA450
KFX 700 V FORCE	2004	59011-0003	90-UA450
KFX 80	2004	590115-003	90-UA421
PRAIRIE 360	2004	59011-0003	90-UA450
PRAIRIE 700 4X4	2004	59011-0003	90-UA450
KFX 80	2003	590115-003	90-UA421
PRAIRIE 360	2003	59011-0003	90-UA450
PRAIRIE 650 (4X4)	2003	59011-0003	90-UA450
PRAIRIE 300	2002	59011-1065	90-UA409
PRAIRIE 400	2002	59011-1066	90-UA410
PRAIRIE 650 (4X4)	2002	59011-0003	90-UA450
PRAIRIE 300	2001	59011-1065	90-UA409
PRAIRIE 400	2001	59011-1066	90-UA410
PRAIRIE 300	2000	59011-1065	90-UA409
PRAIRIE 400	2000	59011-1066	90-UA410
PRAIRIE 300	1999	59011-1065	90-UA409
PRAIRIE 400	1999	59011-1066	90-UA410
PRAIRIE 400	1998	59011-1060	90-UA411
PRAIRIE 400	1997	59011-1060	90-UA411
MULES			
MULE 2500 C5/C1		59011-1057	90-UA429
MULE 2510 4X4 A5/A1		59011-1057	90-UA429
MULE 2520 B5/B1		59011-1057	90-UA429

POLARIS	VM.	OEM	Tuotenro.
RGR RANGER 800 EFI MIDSIZE	2014	3211162	90-UA424
RGR RANGER 800 6X6	2014	3211162	90-UA424
RGR RANGER 800 CREW	2014	3211162	90-UA424
RGR RANGER XP 900	2014	3211149	90-UA441
RGR RANGER 900 CREW	2014	3211149	90-UA441
RGR RANGER 900 DIESEL	2014	3211135	90-UA455
RGR RANGER CREW 900 DIESEL	2014	3211135	90-UA455
RZR 170	2014	0454497	90-UA454
RZR 570	2014	3211143	90-UA457
RZR 800	2014	3211113	90-UA426
RZR 4 800	2014	3211162	90-UA424
RZR S 800	2014	3211162	90-UA424
RZR S 800 INTL EFI	2014	3211162	90-UA424
RZR 900	2014	3211148	90-UA441
RZR 900 INTL	2014	3211148	90-UA441
RZR 4 900	2014	3211148	90-UA441
RZR XP 1000	2014	3211148	90-UA441
RZR XP 4 1000/PS	2014	3211148	90-UA441
SCRAMBLER 850 XP HO/EPS	2014	3211160	90-UA448
SCRAMBLER XP 850 HO EPS INTL	2014	3211160	90-UA448
SPORTSMAN 90	2014	0453455	90-UA415
SPORTSMAN 400 HO 4X4/SE	2014	3211077	90-UA412
SPORTSMAN 550 EPS/XP EPS	2014	3211153	90-UA448
SPORTSMAN XP 550 EPS HD INTL	2014	3211153	90-UA448
SPORTSMAN 570 EFI	2014	3211113	90-UA426
SPORTSMAN 570 EFI EPS	2014	3211113	90-UA426
SPORTSMAN 570 EFI EPS FOREST	2014	3211113	90-UA426
SPORTSMAN 570 EFI HD	2014	3211113	90-UA426
SPORTSMAN 570 FOREST	2014	3211113	90-UA426
SPORTSMAN 800 EFI	2014	3211113	90-UA426
SPORTSMAN 800 EFI 6X6	2014	3211113	90-UA426
SPORTSMAN 800 EFI 6X6 FOREST	2014	3211113	90-UA426
SPORTSMAN 800 EFI FOREST	2014	3211113	90-UA426
SPORTSMAN FOREST TRACTOR 500	2014	3211113	90-UA426
SPORTSMAN FOREST 550	2014	3211153	90-UA448
SPORTSMAN FOREST 850	2014	3211160	90-UA448
SPORTSMAN TOURING 550 EPS	2014	3211153	90-UA448
SPORTSMAN TOURING 570 EFI	2014	3211113	90-UA426
SPORTSMAN TOURING 570 EFI INTL	2014	3211113	90-UA426
SPORTSMAN TOURING EPS 850/HO	2014	3211160	90-UA448
SPORTSMAN TOURING 850 INTL	2014	3211160	90-UA448
SPORTSMAN X2 550 EPS	2014	3211153	90-UA448
SPORTSMAN X2 550 INTL	2014	3211153	90-UA448
SPORTSMAN XP EPS 850/HO	2014	3211160	90-UA448
HAWKEYE 400 HO 2X4	2013	3211077	90-UA412
OUTLAW 50	2013	0453455	90-UA415
OUTLAW 90	2013	0453455	90-UA415
PHOENIX 200	2013	0452496	90-UA453
RANGER 400	2013	3211077	90-UA412
RANGER 500	2013	3211113	90-UA426
RANGER 6X6 800 (Built 10/20/12 & after)	2013	3211162	90-UA424
RANGER 6X6 800 (Built 10/19/12 & before)	2013	3211133	90-UA424
RANGER 800 EFI (Built 10/20/12 & after)	2013	3211162	90-UA424
RANGER 800 EFI (Built 10/19/12 & before)	2013	3211133	90-UA424
RANGER 900 DIESEL	2013	3211135	90-UA455
RANGER 900 XP	2013	3211149	90-UA441
RANGER CREW 500	2013	3211113	90-UA426
RANGER CREW 800 (Built 10/20/12 & after)	2013	3211162	90-UA424
RANGER CREW 800 (Built 10/19/12 & before)	2013	3211133	90-UA424
RANGER CREW 900 DIESEL	2013	3211135	90-UA455
RZR 170	2013	0454497	90-UA454
RZR 570 EFI	2013	3211143	90-UA457
RZR 570 EFI INTL	2013	3211143	90-UA457
RZR 800 EFI	2013	3211113	90-UA426
RZR 800 EFI (high performance belt option)	2013	3211133	90-UA424
RZR 4 XP JAGGED X	2013	3211148	90-UA441
RZR 4 XP 900 EFI	2013	3211148	90-UA441
RZR 4 XP 4 900 PS INTL	2013	3211148	90-UA441
RZR 4 800 EFI (Built 10/20/12 & after)	2013	3211162	90-UA424
RZR 4 800 EFI (Built 10/19/12 & before)	2013	3211133	90-UA424

POLARIS	VM.	OEM	Tuotenro.
HAWKEYE 400 HO 2X4	2014	3211077	90-UA412
OUTLAW 90	2014	0453455	90-UA415
PHOENIX 200	2014	0452496	90-UA453
RGR RANGER 4X4 400	2014	3211077	90-UA412
RGR RANGER 570 EFI	2014	3211169	90-UA457
RGR RANGER CREW 570 EFI	2014	3211169	90-UA457
RGR RANGER 570 INTL	2014	3211169	90-UA457
RGR RANGER 800	2014	3211162	90-UA424



ATV



VARIATTORIHINAT JATKUU

POLARIS	VM.	OEM	Tuoteno.
RZR S 800 EFI	2013	3211162	90-UA424
RZR S 800 EFI (Built 10/20/12 & after)	2013	3211162	90-UA424
RZR S 800 EFI (Built 10/19/12 & before)	2013	3211133	90-UA424
RZR XP 900 EFI	2013	3211148	90-UA441
RZR XP 900 EPS INTL.	2013	3211148	90-UA441
RZR XP 4 900 EFI	2013	3211148	90-UA441
SCRAMBLER 850 HO/EPS (Built 10/15/12 & After)	2013	3211130	90-UA448
SCRAMBLER 850 HO/EPS (Built 10/14/12 & Before)	2013	3211123	90-UA448
850 SCRAMBLER 850 HO EPS INTL (Built 10/15/12 & After)	2013	3211130	90-UA448
850 SCRAMBLER 850 HO EPS INTL (Built 10/14/12 & Before)	2013	3211123	90-UA448
SPORTSMAN 90	2013	0453455	90-UA415
SPORTSMAN 400 HO 4X4	2013	3211077	90-UA412
SPORTSMAN 500 HO - AQ	2013	3211113	90-UA426
SPORTSMAN 500 HO - A13M-H50AJ/AX/AZ	2013	3211077	90-UA412
SPORTSMAN 550	2013	3211153	90-UA448
SPORTSMAN 550 EPS	2013	3211153	90-UA448
SPORTSMAN 800 EFI	2013	3211113	90-UA426
SPORTSMAN 800 EFI 6X6	2013	3211113	90-UA426
SPORTSMAN FOREST 500 A13MH50FU	2013	3211113	90-UA426
SPORTSMAN FOREST 500 - A13MH50FF/FJ	2013	3211077	90-UA412
SPORTSMAN FOREST 550	2013	3211153	90-UA448
SPORTSMAN FOREST 800	2013	3211113	90-UA426
SPORTSMAN FOREST 800 6X6	2013	3211113	90-UA426
SPORTSMAN FOREST 850 (Built 10/15/12 & After)	2013	3211130	90-UA448
SPORTSMAN FOREST 850 (Built 10/14/12 & Before)	2013	3211123	90-UA448
SPORTSMAN FOREST TRACTOR 500	2013	3211113	90-UA426
SPORTSMAN TOURING 500 HO	2013	3211113	90-UA426
SPORTSMAN TOURING 550 EPS	2013	3211153	90-UA448
SPORTSMAN TOURING 550 EPS INTL.	2013	3211153	90-UA448
SPORTSMAN TOURING 850 HO EPS (Built 10/15/12 & After)	2013	3211130	90-UA448
SPORTSMAN TOURING 850 HO EPS (Built 10/14/12 & Before)	2013	3211123	90-UA448
SPORTSMAN TOURING 850 EPS INTL (Built 10/15/12 & After)	2013	3211130	90-UA448
SPORTSMAN TOURING 850 EPS INTL (Built 10/14/12 & Before)	2013	3211123	90-UA448
SPORTSMAN X2 550	2013	3211153	90-UA448
SPORTSMAN X2 550 INTL.	2013	3211153	90-UA448
SPORTSMAN XP 850 (Built 10/15/12 & After)	2013	3211130	90-UA448
SPORTSMAN XP 850 (Built 10/14/12 & Before)	2013	3211123	90-UA448
SPORTSMAN XP 850 HO EPS (Built 10/15/12 & After)	2013	3211130	90-UA448
SPORTSMAN XP 850 HO EPS (Built 10/14/12 & Before)	2013	3211123	90-UA448
TRAIL BLAZER 330	2013	3211077	90-UA412
TRAIL BLAZER 330 INTL.	2013	3211077	90-UA412
TRAIL BOSS 330	2013	3211077	90-UA412
TRAIL BOSS 330 INTL.	2013	3211077	90-UA412
HAWKEYE 400 HO 2X4	2012	3211077	90-UA412
OUTLAW 50	2012	0453455	90-UA415
OUTLAW 90	2012	0453455	90-UA415
PHOENIX 200	2012	0452496	90-UA453
RANGER 400 4X4	2012	3211077	90-UA412
RANGER 500 4X4	2012	3211113	90-UA426
RANGER 6X6 800 EFI	2012	3211133	90-UA424
RANGER 900 DIESEL	2012	3211135	90-UA455
RANGER CREW 500	2012	3211113	90-UA426
RANGER CREW 800	2012	3211133	90-UA424
RANGER CREW 900 DIESEL 4X4	2012	3211135	90-UA455
RZR 170	2012	0454497	90-UA454
RZR 570 EFI	2012	3211143	90-UA457
RZR 800 EFI	2012	3211113	90-UA426
RZR 4 800 EFI	2012	3211133	90-UA424
RZR 4 800 EFI EPS	2012	3211133	90-UA424
RZR S 800 EFI	2012	3211133	90-UA424
RZR XP 800	2012	3211136	90-UA456
RZR XP INTL	2012	3211148	90-UA441
RZR XP 900 EFI	2012	3211148	90-UA441

POLARIS	VM.	OEM	Tuoteno.
SCRAMBLER 500 4X4	2012	3211077	90-UA412
SPORTSMAN 90	2012	0453455	90-UA415
SPORTSMAN 400 HO 4X4	2012	3211077	90-UA412
SPORTSMAN 500 HO	2012	3211113	90-UA426
SPORTSMAN 550	2012	3211123	90-UA448
SPORTSMAN EPS 550	2012	3211123	90-UA448
SPORTSMAN X2 550	2012	3211123	90-UA448
SPORTSMAN 800 EFI	2012	3211113	90-UA426
SPORTSMAN 800 EFI 6X6	2012	3211113	90-UA426
SPORTSMAN 850	2012	3211123	90-UA448
SPORTSMAN XP 850	2012	3211123	90-UA448
SPORTSMAN XP EPS 850	2012	3211123	90-UA448
SPORTSMAN TOURING 500 H.O.	2012	3211113	90-UA426
SPORTSMAN TOURING 550 EPS	2012	3211123	90-UA448
SPORTSMAN TOURING 850 EPS	2012	3211123	90-UA448
SPORTSMAN TRACTOR 500	2012	3211113	90-UA426
TRAIL BLAZER 330	2012	3211077	90-UA412
TRAIL BOSS 330	2012	3211077	90-UA412
HAWKEYE 2X4	2011	3211131	90-UA440
RANGER SERIES 11	2011	3211077	90-UA412
RANGER 400	2011	3211077	90-UA412
RANGER CREW 500	2011	3211113	90-UA426
RANGER 4X4 500 EFI	2011	3211113	90-UA426
RANGER CREW 800	2011	3211133	90-UA424
RANGER 4X4 800 EFI	2011	3211133	90-UA424
RANGER 6X6 800 EFI	2011	3211133	90-UA424
RANGER RZR 4/EPS RGE	2011	3211133	90-UA424
RANGER RZR "S" 800 EFI	2011	3211133	90-UA424
RANGER RZR EPS	2011	3211133	90-UA424
RANGER RZR 4 800 EFI	2011	3211113	90-UA424
RANGER RZR 800 EFI	2011	3211113	90-UA424
SCRAMBLER 500 4X4	2011	3211077	90-UA412
SPORTSMAN 550	2011	3211123	90-UA448
SPORTSMAN EPS 550	2011	3211123	90-UA448
SPORTSMAN X2 550	2011	3211123	90-UA448
SPORTSMAN XP EPS 850	2011	3211123	90-UA448
SPORTSMAN X2 850	2011	3211123	90-UA448
SPORTSMAN XP 850	2011	3211123	90-UA448
SPORTSMAN TOURING 500 H.O.	2011	3211113	90-UA426
SPORTSMAN TOURING 550 EPS	2011	3211123	90-UA448
SPORTSMAN TOURING 850 EPS	2011	3211123	90-UA448
TRAIL BLAZER 330	2011	3211077	90-UA412
TRAIL BOSS 330	2011	3211077	90-UA412
HAWKEYE 300	2010	3211131	90-UA440
RANGER 400,500	2010	3211077	90-UA412
RANGER 800	2010	3211133	90-UA424
RANGER 800 RZR	2010	3211113	90-UA426
SCRAMBLER 500	2010	3211077	90-UA412
SPORTSMAN 300,400	2010	3211131	90-UA440
SPORTSMAN 500 H.O.	2010	3211077	90-UA412
SPORTSMAN 550	2010	3211113	90-UA426
SPORTSMAN 550 TOURING	2010	3211123	90-UA448
SPORTSMAN 800	2010	3211113	90-UA426
SPORTSMAN 850 XP,TOURING	2010	3211123	90-UA448
TRAIL BLAZER 330	2010	3211077	90-UA412
TRAIL BOSS 330	2010	3211077	90-UA412
HAWKEYE 300	2009	3211131	90-UA440
RANGER 4X4 500	2009	3211077	90-UA412
RANGER 6X6 700	2009	3211118	90-UA424
RANGER CREW 700	2009	3211118	90-UA424
RANGER HD 700	2009	3211118	90-UA424
RANGER XP 700	2009	3211118	90-UA424
RANGER RZR 800	2009	3211113	90-UA426
SCRAMBLER 4X4 500	2009	3211077	90-UA412
SPORTSMAN 300	2009	3211131	90-UA440
SPORTSMAN 400 H.O.	2009	3211131	90-UA440
SPORTSMAN 500 H.O.	2009	3211077	90-UA412
SPORTSMAN 500 EFI	2009	3211113	90-UA426
SPORTSMAN 500 EFI X2	2009	3211113	90-UA426
SPORTSMAN 500 EFI TOURING	2009	3211113	90-UA426
SPORTSMAN 800 EFI 6X6	2009	3211113	90-UA426
SPORTSMAN 800 EFI	2009	3211113	90-UA426
SPORTSMAN 800 EFI X2	2009	3211113	90-UA426
SPORTSMAN 800 EFI TOURING	2009	3211113	90-UA426
TRAIL BLAZER 330	2009	3211077	90-UA412
TRAIL BOSS 330	2009	3211077	90-UA412
SPORTSMAN 500 EFI	2008	3211113	90-UA426
SPORTSMAN 800 EFI	2008	3211113	90-UA426



VARIATTORIHINNAT JATKUU

POLARIS	VM.	OEM	Tuotenro.
RANGER RZR 800	2008	3211113	90-UA426
SPORTSMAN X2 500	2008	3211113	90-UA426
SPORTSMAN X2 700	2008	3211113	90-UA426
SPORTSMAN X2 800	2008	3211113	90-UA426
SPORTSMAN 800 EFI	2007	3211113	90-UA426
SPORTSMAN700EFI	2007	3211113	90-UA426
SPORTSMAN500EFI	2007	3211113	90-UA426
SPORTSMAN 450	2007	3211077	90-UA412
SPORTSMAN 6X6	2007	3211077	90-UA412
SPORTSMAN X2 800EFI	2007	3211113	90-UA426
SPORTSMAN X2 500EFI	2007	3211113	90-UA426
HAWKEYE 2X4	2007	3211108	90-UA427
HAWKEYE 4X4	2007	3211108	90-UA427
TRAILBOSS 330	2007	3211077	90-UA412
SCRAMBLER 500	2007	3211077	90-UA412
RANGER 700EFI 6X6	2007	3211106	90-UA424
RANGER 500 EFI 4X4	2007	3211077	90-UA412
RANGER 700EFI/LE 4X4	2007	3211106	90-UA424
SPORTSMAN 800 EFI	2006	3211106	90-UA424
SPORTSMAN 700 EFI	2006	3211069	90-UA413
SPORTSMAN 700 TWIN	2006	3211069	90-UA413
SPORTSMAN 500 EFI	2006	3211069	90-UA413
SPORTSMAN 500 H.O.	2006	3211077	90-UA412
SPORTSMAN 450	2006	3211077	90-UA412
SPORTSMAN X2	2006	3211069	90-UA413
SPORTSMAN MV7	2006	3211069	90-UA413
SPORTSMAN 6X6	2006	3211077	90-UA412
HAWKEYE 2X4	2006	3211108	90-UA427
HAWKEYE 4X4	2006	3211108	90-UA427
MAGNUM 330 4X4	2006	3211077	90-UA412
TRAIL BOSS 330	2006	3211077	90-UA412
SCRAMBLER 500	2006	3211077	90-UA412
TRAIL BLAZER 250	2006	3211077	90-UA412
SPORTSMAN 90	2006	0450239	90-UA436
PREDATOR 90	2006	0450239	90-UA436
RANGER 500 2X4/4X4	2006	3211077	90-UA412
RANGER 500 4X4 EFI	2006	3211077	90-UA412
RANGER 6X6 EFI 700	2006	3211106	90-UA424
RANGER XP 4X4 700	2006	3211106	90-UA424
SPORTSMAN 800 TWIN EFI	2005	3211106	90-UA424
SPORTSMAN 700 TWIN EFI	2005	3211069	90-UA413
SPORTSMAN 700 TWIN	2005	3211069	90-UA413
SPORTSMAN 600 TWIN	2005	3211069	90-UA413
SPORTSMAN 500 H.O.	2005	3211069	90-UA413
SPORTSMAN 400	2005	3211077	90-UA412
SPORTSMAN 6X6	2005	3211077	90-UA412
SPORTSMAN 700 MV	2005	3211069	90-UA413
ATP 500 H.O.	2005	3211069	90-UA413
ATP 330	2005	3211077	90-UA412
MAGNUM 330 2X4	2005	3211077	90-UA412
MAGNUM 330 4X4	2005	3211077	90-UA412
TRAIL BOSS 330	2005	3211077	90-UA412
TRAIL BLAZER 250	2005	3211077	90-UA412
SCRAMBLER 500	2005	3211077	90-UA412
RANGER 2X4/4X4/6X6	2005	3211077	90-UA412
RANGER XP	2005	3211106	90-UA424
ATP 330	2004	3211077	90-UA412
ATP 500 HO	2004	3211069	90-UA413
MAGNUM 330 2X4	2004	3211077	90-UA412
MAGNUM 330 4X4	2004	3211077	90-UA412
PTV 4X4	2004	3211077	90-UA412
PTV 6X6	2004	3211077	90-UA412
RANGER 2X4	2004	3211077	90-UA412
RANGER 4X4	2004	3211077	90-UA412
RANGER 6X6	2004	3211077	90-UA412
SCRAMBLER 500	2004	3211077	90-UA412
SPORTSMAN 400	2004	3211077	90-UA412
SPORTSMAN 500 HO	2004	3211069	90-UA413
SPORTSMAN 500 HO MOSSY OAK	2004	3211069	90-UA413
SPORTSMAN 600 TWIN	2004	3211069	90-UA413
SPORTSMAN 6X6	2004	3211077	90-UA412
SPORTSMAN 700 TWIN	2004	3211069	90-UA413
SPORTSMAN 700 TWIN EFI	2004	3211069	90-UA413
SPORTSMAN 700 TWIN MOSSY OAK	2004	3211069	90-UA413
TRAIL BLAZER 250	2004	3211077	90-UA412
TRAIL BOSS 330	2004	3211077	90-UA412



POLARIS	VM.	OEM	Tuotenro.
UTV 2X4	2004	3211077	90-UA412
UTV 4X4	2004	3211077	90-UA412
UTV 6X6	2004	3211077	90-UA412
RANGER 2X4/4X4/6X6	2004	3211077	90-UA412
MAGNUM 330 2X4	2003	3211077	90-UA412
MAGNUM 330 4X4	2003	3211077	90-UA412
RANGER 2X4	2003	3211077	90-UA412
RANGER 4X4	2003	3211077	90-UA412
RANGER 6X6	2003	3211077	90-UA412
SCRAMBLER 500 4X4	2003	3211077	90-UA412
SPORTSMAN 400	2003	3211077	90-UA412
SPORTSMAN 500 HO	2003	3211069	90-UA413
SPORTSMAN 600 TWIN	2003	3211069	90-UA413
SPORTSMAN 6X6	2003	3211077	90-UA412
SPORTSMAN 700 TWIN	2003	3211069	90-UA413
SPORTSMAN 90	2003	3211069	90-UA413
TRAIL BLAZER 250	2003	3211077	90-UA412
TRAIL BLAZER 400	2003	3211077	90-UA412
TRAIL BOSS 330	2003	3211077	90-UA412
INT'L BIG BOSS 6X6	2003	3211069	90-UA413
MAGNUM 500 2X4 HDS	2002	3211069	90-UA413
MAGNUM 500 RMK	2002	3211069	90-UA413
MAGNUM 500 VL HDS	2002	3211069	90-UA413
SCRAMBLER 500 (4X4)	2002	3211077	90-UA412
SPORTSMAN 400	2002	3211077	90-UA412
SPORTSMAN 6X6	2002	3211077	90-UA412
SPORTSMAN 700 TWIN	2002	3211069	90-UA413
SRAMBLER 400 (2X4)	2002	3211069	90-UA413
TRAIL BLAZER 250	2002	3211077	90-UA412
ALL DIESEL MODELS	2001	3211069	90-UA413
XPEDITION 325	2001	3211069	90-UA413
INT'L BIG BOSS 6X6	2001	3211069	90-UA413
MAGNUM 325	2001	3211077	90-UA412
MAGNUM 500	2001	3211069	90-UA413
MAGNUM 500 w/EB	2001	3211069	90-UA413
SCRAMBLER 400 (2X4)	2001	3211077	90-UA412
SCRAMBLER 500	2001	3211077	90-UA412
SPORTSMAN 500 HO	2001	3211077	90-UA412
SPORTSMAN 500 HO DUSE	2001	3211077	90-UA412
SPORTSMAN 500 HO DUSE w/EB	2001	3211069	90-UA413
SPORTSMAN 500 HO RSE	2001	3211077	90-UA412
SPORTSMAN 500 HO w/EB	2001	3211069	90-UA413
SPORTSMAN 6X6	2001	3211077	90-UA412
TRAIL BLAZER 250	2001	3211077	90-UA412
TRAIL BOSS 325	2001	3211077	90-UA412
XPLORER 400	2001	3211077	90-UA412
XPLORER 4X4	2001	3211077	90-UA412
ATV'S (NON EBS)	2000	3211077	90-UA412
INT'L BIG BOSS	2000	3211069	90-UA413
DEISEL	2000	3211069	90-UA413
MAGNUM 325	2000	3211077	90-UA412
MAGNUM 500	2000	3211077	90-UA412
MAGNUM 500 w/EB	2000	3211069	90-UA413
SCRAMBLER 400 (2X4)	2000	3211077	90-UA412
SCRAMBLER 400 (4X4)	2000	3211077	90-UA412
SCRAMBLER 500	2000	3211077	90-UA412
SPORTSMAN 335	2000	3211077	90-UA412
SPORTSMAN 500	2000	3211069	90-UA413
SPORTSMAN 500 RSE	2000	3211077	90-UA412
SPORTSMAN 6X6	2000	3211077	90-UA412
TRAIL BLAZER 250	2000	3211077	90-UA412
TRAIL BOSS 325	2000	3211077	90-UA412
XPLORER 400	2000	3211077	90-UA412
RANGER	1999	3211077	90-UA412
ATV'S (NON EBS)	1999	3211077	90-UA412
ATV'S (ALL MODELS)	1998	3211077	90-UA412
ATV'S (ALL MODELS)	1990-97	3211077	90-UA412
SUZUKI	VM.	OEM	Tuotenro.
KING QUAD 400 AS / ASI	2013	27601-38F00	UA400
KING QUAD 450 AXI	2013	27601-11H00	UA443
KING QUAD 500 AXI	2013	27601-11H00	UA443
KING QUAD 750 AXI	2013	27601-31G00	UA437
KING QUAD 400AXI	2012	27601-38F00	90-UA400
KING QUAD 450AXI	2012	27601-11H00	90-UA443



VARIATTORIIHNAT JATKUU

SUZUKI	VM.	OEM	Tuotenro.
KING QUAD 500AXI	2012	27601-11H00	90-UA443
KING QUAD 750AXI	2012	27601-31G00	90-UA437
KING QUAD 400AXI	2011	27601-38F00	90-UA400
KING QUAD 450AXI	2011	27601-11H00	90-UA443
KING QUAD 500AXI	2011	27601-11H00	90-UA443
KING QUAD 750AXI	2011	27601-31G00	90-UA437
KING QUAD 400AXI	2010	27601-38F00	90-UA400
KING QUAD 450AXI	2010	27601-11H00	90-UA443
KING QUAD 500AXI	2010	27601-11H00	90-UA443
KING QUAD 750AXI	2010	27601-31G00	90-UA437
KING QUAD 400AS	2009	27601-38F00	90-UA400
KING QUAD 400FS	2009	27601-38F00	90-UA400
KING QUAD 750AXI	2009	27601-31G00	90-UA437
EIGER 400 4X4 AUTO	2008	27601-38F00	90-UA400
KING QUAD 400AS	2008	27601-38F00	90-UA400
KING QUAD 400FS	2008	27601-38F00	90-UA400
KING QUAD 750 AXI	2008	27601-31G00	90-UA437
LT-A700 X KINGQUAD 700 4X4	2007	27601-31G00	90-UA437
LT-A500 F VINSON 500 4X4 AUTO	2007	27601-09F60	90-UA401
LT-A400 F EIGER 400 4X4 & 4X2 AUTO	2007	27601-38F00	90-UA400
KING QUAD 700 4X4	2006	27601-31G00	90-UA437
TWIN PEAKS 700 4X4	2006	K5901-10003	90-UA450
VINSON 500 4X4	2006	27601-09F60	90-UA401
EIGER 400 4X4	2006	27601-38F00	90-UA400
QUADSPORT 80	2006	27601-40B01	90-UA421
KINGQUAD 700	2005	27601-31G00	90-UA437
TWIN PEAK 700	2005	K5901-10003	90-UA450
VINSON 500 4X4 AUTO	2005	27601-09F60	90-UA401
EIGER 400 4X4 AUTOMATIC	2005	27601-38F00	90-UA400
QUADSPORT 80	2005	27601-40B01	90-UA421
Q.U.V. K5901-11077	2005	K5901-11077	90-UA427
LTA400F EIGER AUTO 4WD	2004	27601-38F00	90-UA400
LTA400 EIGER AUTO 2WD	2004	27601-38F00	90-UA400
LT80	2004	27601-40B01	90-UA421
TWIN PEAK 700	2004	K5901-10003	90-UA450
LTA500F VINSON AUTO 4WD	2004	27601-09F60	90-UA401
LTA400F EIGER AUTO 4WD	2003	27601-38F00	90-UA400
LTA400 EIGER AUTO 2WD	2003	27601-38F00	90-UA400
LT80	2003	27601-40B01	90-UA421
LTA500F VINSON AUTO 4WD	2003	27601-09F60	90-UA401
LTA400F EIGER AUTO 4WD	2002	27601-38F00	90-UA400
LTA400 EIGER AUTO 2WD	2002	27601-38F00	90-UA400
LT80	2002	27601-40B01	90-UA421
LTA500F VINSON AUTO 4WD	2002	27601-09F60	90-UA401
LT80	2001	27601-40B01	90-UA421
LTA500F AUTO QUAD MASTER	2001	27601-09F60	90-UA401
LT80	2000	27601-40B01	90-UA421
LTA500F AUTO 4WD	2000	27601-09F60	90-UA401
LT80	1987-99	27601-40B01	90-UA421

YAMAHA	VM.	OEM	Tuotenro.
GRIZZLY 350	2014	5UH-17641-01-00	90-UA416
GRIZZLY 450	2014	5GH-17641-10-00	90-UA417
GRIZZLY 450 EPS	2014	5GH-17641-10-00	90-UA417
GRIZZLY 550 FI	2014	28P-17641-00-00	90-UA422
GRIZZLY 550 FI EPS	2014	28P-17641-00-00	90-UA422
GRIZZLY 700 FI	2014	3B4-17641-00-00	90-UA422
GRIZZLY 700 FI EPS	2014	3B4-17641-00-00	90-UA422
GRIZZLY 700 FI EPS SE	2014	3B4-17641-00-00	90-UA422
VIKING 700	2014	1XD-17641-00-00	90-UA464
VIKING 700 EPS	2014	1XD-17641-00-00	90-UA464
GRIZZLY 125 Automatic	2013	3FA-17641-00-00	90-UA425
GRIZZLY 300 Automatic	2013	15C-E7641-00-00	N/A
GRIZZLY 350 Auto, 4X4	2013	5UH-17641-01-00	90-UA416
GRIZZLY 450 Auto, 4x4	2013	5GH-17641-10-00	90-UA417
GRIZZLY 450 Auto, 4x4 EPS	2013	5GH-17641-10-00	90-UA417
GRIZZLY 550 FI Auto, 4x4	2013	28P-17641-00-00	90-UA422
GRIZZLY 550 FI Auto, 4x4 EPS	2013	28P-17641-00-00	90-UA422
GRIZZLY 700 FI Auto 4X4	2013	3B4-17641-00-00	90-UA422
GRIZZLY 700 FI Auto, 4X4 EPS	2013	3B4-17641-00-00	90-UA422
RHINO 700	2013	5B4-17641-00-00	90-UA438
GRIZZLY 125 Automatic	2012	3FA-17641-00-00	90-UA425
GRIZZLY 350 Automatic	2012	5UH-17641-01-00	90-UA416
GRIZZLY 350 Auto, 4X4	2012	5UH-17641-01-00	90-UA416
GRIZZLY 350 Auto, 4X4 IRS	2012	5UH-17641-01-00	90-UA416

YAMAHA	VM.	OEM	Tuotenro.
GRIZZLY 450 Auto, 4x4	2012	5GH-17641-10-00	90-UA417
GRIZZLY 450 Auto, 4x4 EPS	2012	5GH-17641-10-00	90-UA417
GRIZZLY 550 FI Auto, 4x4	2012	28P-17641-00-00	90-UA422
GRIZZLY 550 FI Auto, 4x4 EPS	2012	28P-17641-00-00	90-UA422
GRIZZLY 700 4WD	2012	28P-17641-00-00	90-UA422
GRIZZLY 700 FI Auto, 4X4 EPS	2012	28P-17641-00-00	90-UA422
RHINO 700	2012	5B4-17641-00-00	90-UA438
GRIZZLY 125 Automatic	2011	3FA-17641-00-00	90-UA425
GRIZZLY 350 Automatic	2011	5UH-17641-01-00	90-UA416
GRIZZLY 350 Auto, 4X4	2011	5UH-17641-01-00	90-UA416
GRIZZLY 350 Auto, 4X4 IRS	2011	5UH-17641-01-00	90-UA416
GRIZZLY 450 Auto, 4x4	2011	5GH-17641-10-00	90-UA417
GRIZZLY 450 Auto, 4x4 EPS	2011	5GH-17641-10-00	90-UA417
GRIZZLY 550 FI Auto, 4x4	2011	28P-17641-00-00	90-UA422
GRIZZLY 550 FI Auto, 4x4 EPS	2011	28P-17641-00-00	90-UA422
GRIZZLY 700 4WD	2011	28P-17641-00-00	90-UA422
GRIZZLY 700 FI Auto, 4X4 EPS	2011	28P-17641-00-00	90-UA422
GRIZZLY 125	2010	3FA-17641-00-00	90-UA425
GRIZZLY 350 AUTO	2010	5UH-17641-01-00	90-UA416
GRIZZLY 450 AUTO 4X4 IRS	2010	5GH-17641-10-00	90-UA417
GRIZZLY 700 4X4	2010	3B4-17641-00-00	90-UA422
WOLVERINE 450 AUTO 4X4	2010	3C2-17641-00-00	90-UA417
GRIZZLY 120 AUTO	2009	3FA-17641-00-00	90-UA425
GRIZZLY 350 AUTO	2009	5UH-17641-01-00	90-UA416
GRIZZLY 350 AUTO 4X4	2009	5UH-17641-01-00	90-UA416
GRIZZLY 350 AUTO 4X4 IRS	2009	5UH-17641-01-00	90-UA416
GRIZZLY 450 AUTO 4X4 IRS	2009	5GH-17641-10-00	90-UA417
GRIZZLY 700 FI AUTO 4X4	2009	3B4-17641-00-00	90-UA422
GRIZZLY 700 FI AUTO 4X4 EPS	2009	3B4-17641-00-00	90-UA422
WOLVERINE 450 AUTO 4X4	2009	3C2-17641-00-00	90-UA417
GRIZZLY 125	2008	3FA-17641-00-00	90-UA425
GRIZZLY 350	2008	5UH-17641-01-00	90-UA416
GRIZZLY 350 4X4	2008	5UH-17641-01-00	90-UA416
GRIZZLY 450 4X4	2008	5GH-17641-10-00	90-UA417
GRIZZLY 660 Auto 4X4	2008	5KM-17641-01-00	90-UA422
GRIZZLY 700 Auto 4X4	2008	3B4-17641-00-00	90-UA422
RHINO 450 AUTO 4X4	2008	5GH-17641-10-00	90-UA417
RHINO 660	2008	5KM-17641-01-00	90-UA422
RHINO 700 AUTO 4X4	2008	3B4-17641-00-00	90-UA422
WOLVERINE 350	2008	5UH-17641-01-00	90-UA416
WOLVERINE 450	2008	3C2-17641-00-00	90-UA417
2007 GRIZZLY 125 AUTOMATIC	2007	3FA-17641-00-00	90-UA425
2007 GRIZZLY 350 4WD & 2WD	2007	5UH-17641-00-00	90-UA416
2007 WOLVERINE 350 2WD SPORT	2007	5UH-17641-00-00	90-UA416
2007 GRIZZLY 400	2007	5GH-17641-00-00	90-UA417
2007 GRIZZLY 450	2007	5GH-17641-00-00	90-UA417
2007 GRIZZLY 660	2007	5KM-17641-00-00	90-UA422
2006 KODIAK 450 AUTO 4X4	2006	5GH-17641-00-00	90-UA417
2006 GRIZZLY 660 AUTO 4X4	2006	5KM-17641-00-00	90-UA422
2006 KODIAK 400 AUTO 4X4	2006	5GH-17641-00-00	90-UA417
2006 BRUIN 350 AUTO 4X4	2006	5UH-17641-00-00	90-UA416
2006 BRUIN 350 2X4	2006	5UH-17641-00-00	90-UA416
2006 RHINO 450	2006	5GH-17641-00-00	90-UA417
2006 RHINO 660 4WD	2006	5KM-17641-00-00	90-UA422
2005 GRIZZLY 660 AUTO 4X4	2005	5KM-17641-00-00	90-UA422
2005 KODIAK 450 AUTO 4X4	2005	5GH-17641-00-00	90-UA417
2005 KODIAK 400 AUTO 4X4	2005	5GH-17641-00-00	90-UA417
2005 BRUIN 350 AUTO 4X4	2005	5UH-17641-00-00	90-UA416
2005 BRUIN 350 AUTO	2005	5UH-17641-00-00	90-UA416
2004 BREEZE	2004	3FA-17641-00-00	90-UA425
2004 BREEZE	2004	3FA-17641-00-00	90-UA425
2004 GRIZZLY 125	2004	3FA-17641-00-00	90-UA425
2004 BRUIN 350 AUTO 4X4 HDW CAMO	2004	5UH-17641-00-00	90-UA416
2004 BRUIN 350 AUTO 4X4	2004	5UH-17641-00-00	90-UA416
2004 BRUIN 350 AUTO 2WD	2004	5UH-17641-00-00	90-UA416
2004 BRUIN 350 AUTO HDW	2004	5UH-17641-00-00	90-UA416
2004 BRUIN 350 AUTO	2004	5UH-17641-00-00	90-UA416
2004 KODIAK 450 AUTO 4X4 HDW CAMO	2004	5GH-17641-00-00	90-UA417
2004 KODIAK 450 AUTO 4X4	2004	5GH-17641-00-00	90-UA417
2004 KODIAK 400 2WD	2004	5GH-17641-00-00	90-UA417

Vanteet ja renkaat

Talvituet

Vinsit

Laukut ja tuulisuojat

Sähköosat

Jousitus ja voimansiirto

Pakoputket ja suutinsarjat

Ohjauk

Rungon osat ja peitteet

Jarrupalat ja rattaat

Moottori

Variaattorin osat

Maatalous-tarvikkeet

Kärryt ja reet

90-UA425

90-UA425

90-UA425

90-UA416

90-UA416

90-UA416

90-UA416

90-UA417

90-UA417

90-UA417

ATV



Vanteet ja renkaat



Talvituotteet



Vinssit



Laukut ja tuulisuojat



Sähköosat



Jousitus ja voimansiirto



Pakoputket ja suutinsarjat



Ohjaus



Rungon osat ja peitteet



Jarrupalat ja rattaat



Moottori



Variaattorin osat



Maatalous-tarvikkeet



Kärryt ja reet

ATV



VARIATTORIIHINNAT JATKUU

YAMAHA	VM.	OEM	Tuoteno.
2004 KODIAK 400 AUTO 4X4 HDW CAMO	2004	5GH-17641-00-00	90-UA417
2004 KODIAK 400 AUTO 4X4	2004	5GH-17641-00-00	90-UA417
2004 GRIZZLY 660 HDW CAMO	2004	5KM-17641-00-00	90-UA422
2004 GRIZZLY 660 AUTO 4X4 WETLAND	2004	5KM-17641-00-00	90-UA422
2004 GRIZZLY 660 AUTO 4X4 LIMITED	2004	5KM-17641-00-00	90-UA422
2004 GRIZZLY 660	2004	5KM-17641-00-00	90-UA422
2003 BREEZE	2003	3FA-17641-00-00	90-UA425
2003 GRIZZLY 660	2003	5KM-17641-00-00	90-UA422
2003 GRIZZLY 660 4X4	2003	5KM-17641-00-00	90-UA422
2003 KODIAK 400	2003	5GH-17641-00-00	90-UA417
2003 KODIAK 400 4WD	2003	5GH-17641-00-00	90-UA417
2003 KODIAK 450 4WD	2003	5GH-17641-00-00	90-UA417
2002 BREEZE	2002	3FA-17641-00-00	90-UA425
2002 GRIZZLY	2002	5KM-17641-00-00	90-UA422
2002 KODIAK 400 4WD	2002	5GH-17641-00-00	90-UA417
2002 KODIAK 450 4WD	2002	5GH-17641-00-00	90-UA417
2001 BREEZE	2001	3FA-17641-00-00	90-UA425
2001 GRIZZLY	2001	4WV-17641-00-00	90-UA423
2001 KODIAK 400 4WD	2001	5GH-17641-00-00	90-UA417
2001 KODIAK 450 4WD	2001	5GH-17641-00-00	90-UA417
2001 KODIAK 2WD	2001	5GH-17641-00-00	90-UA417
2001 KODIAK 4WD	2001	5GH-17641-00-00	90-UA417
2000 BREEZE	2000	3FA-17641-00-00	90-UA425
2000 GRIZZLY	2000	4WV-17641-00-00	90-UA423
2000 KODIAK 2WD	2000	5GH-17641-00-00	90-UA417
2000 KODIAK 4WD	2000	5GH-17641-00-00	90-UA417
1999 BREEZE	1999	3FA-17641-00-00	90-UA425
1999 GRIZZLY	1999	4WV-17641-00-00	90-UA423
1998 BREEZE	1999	3FA-17641-00-00	90-UA425
1998 GRIZZLY	1999	4WV-17641-00-00	90-UA423
1989 - 97 BREEZE	1989-97	3FA-17641-00-00	90-UA425

HINTA & MITTATAULUKKO

Tuoteno	Ulkohalk.	Leveys	Ovh.
90-UA400	842mm	30,0mm	114,50
90-UA401	948mm	36,5mm	117,00
90-UA402	893mm	17,5mm	79,00
90-UA403	677mm	17,5mm	73,00
90-UA404	1115mm	30,0mm	130,50
90-UA405			126,50
90-UA406	933mm	37,0mm	129,50
90-UA409	997mm	31,75mm	123,50
90-UA410	1029mm	32,5mm	125,00
90-UA411	1071mm	26,5mm	128,00
90-UA412	1041mm	29,5mm	83,50
90-UA413	1041mm	29,5mm	83,50
90-UA414	681mm	17,85mm	73,00
90-UA415	720mm	17,5mm	73,00
90-UA416	855mm	30,0mm	119,50
90-UA417	876mm	30,5mm	116,00
90-UA419	982mm	33,5mm	129,50
90-UA420	948mm	33,0mm	129,50
90-UA421	758mm	18,25mm	79,00

Tuoteno	Ulkohalk.	Leveys	Ovh.
90-UA422	939mm	33,0mm	120,00
90-UA423	944mm	32,0mm	120,00
90-UA424	1047mm	30,0mm	129,50
90-UA425	938mm	19,85mm	120,50
90-UA426	1038mm	29,5mm	103,50
90-UA427	1107mm	35,0mm	83,50
90-UA428			79,00
90-UA429	1110mm	31,5mm	103,50
90-UA433			115,50
90-UA434			73,00
90-UA435	942mm	31,75mm	115,50
90-UA436	893mm	17,0mm	73,00
90-UA437	947mm	36,5mm	117,00
90-UA438			120,00
90-UA439			108,50
90-UA440	1097mm	35,0mm	78,50
90-UA441			156,00
90-UA442			96,50

Tuoteno	Ulkohalk.	Leveys	Ovh.
90-UA443	903mm	33,5mm	117,00
90-UA444			84,00
90-UA445	948mm	36,5mm	131,00
90-UA446	974mm	33,5mm	137,50
90-UA448	1014mm	31,75mm	137,50
90-UA450	845mm	28,5mm	115,00
90-UA451			108,50
90-UA452			115,00
90-UA453			88,00
90-UA454			79,00
90-UA455			148,00
90-UA456			156,00
90-UA457			103,50
90-UA458			118,50
90-UA459			118,50
90-UA460			75,50
90-UA462			47,50
90-UA463			75,50

VARIAATTORIHINNAT



ARCTIC CAT				
375 2x4 / 4x4	2002	3402-664	70-03856	63,60
400 2x4 Auto	2003-04	3402-664	70-03856	63,60
400 4x4 Auto	2004-08	3402-664	70-03856	63,60
400 4x4 Auto ACT	2003	3402-664	70-03856	63,60
400 4x4 Auto LE	2005-08	3402-664	70-03856	63,60
400 4x4 Auto TBX	2004-06	3402-664	70-03856	63,60
400 4x4 Auto VP	2005-06	3402-664	70-03856	63,60
400 DVX	2007	3402-664	70-03856	63,60
400 4x4 TRV PLUS	2007	3402-664	70-03856	63,60
CAN AM/BOMBARDIER				
Outlander 330/400 STD 2X4/4X4	2004-05	420280280	70-03860	63,60
Outlander 400 XT 4 X 4	2004-05	420280280	70-03860	63,60
Outlander 400	2003-05	420280280	70-03860	63,60
Outlander MAX 400	2004-05	420280280	70-03860	63,60
Outlander 400 EFI STD	2005-08	715900024	70-03860	63,60
Outlander 400 EFI XT	2005-08	715900024	70-03860	63,60
Outlander 400 EFI	2005-10	715900024	70-03860	63,60
Outlander 400 STD 4 X 4	2005-07	715900024	70-03860	63,60
Outlander 400 STD	2005-08	715900024	70-03860	63,60
Outlander 400 XT 4 X 4	2005-07	715900024	70-03860	63,60
Outlander 400 XT	2005-08	715900024	70-03860	63,60
Outlander MAX 400 EFI STD	2005-08	715900024	70-03860	63,60
Outlander MAX 400 EFI XT	2005-08	715900024	70-03860	63,60
Outlander Max 400 EFI	2005-10	715900024	70-03860	63,60
Outlander MAX 400 STD 4 X 4	2005-07	715900024	70-03860	63,60
Outlander MAX 400 STD	2005-08	715900024	70-03860	63,60
Outlander MAX 400 XT	2005-08	715900024	70-03860	63,60
Quest 500/XT 4x4	2003-04	420280360	70-03860	63,60
Quest 650 4x4	2003	420280360	70-03860	63,60
KAWASAKI				
Prairie 360	2005-10	59011-0003	70-03850	63,60
Brute Force 650 4x4	2005-10	59011-0003	70-03850	63,60
Prairie 700	2004-06	59011-0003	70-03850	63,60
Brute Force 750	2005-10	59011-0003	70-03850	63,60
KFX700 V-FORCE	2004-09	59011-0003	70-03850	63,60
POLARIS				
325 MAGNUM 2X4 HDS	2000-02	3211077	70-03854	63,60
325 MAGNUM 4X4 HDS/ HDS II	2000-01	3211077	70-03854	63,60
ATP 330 4X4	2004-05	3211077	70-03854	63,60
BIG BOSS 500 6X6	1998	3211077	70-03854	63,60
INT'L BIG BOSS	2000-02	3211077	70-03854	63,60
LUH 6X6 PPS	2002	3211077	70-03854	63,60
MAGNUM 2X4/4X4	1998	3211077	70-03854	63,60
MAGNUM 325 2X4/4X4	2000-02	3211077	70-03854	63,60
MAGNUM 330 2X4/4X4	2003-06	3211077	70-03854	63,60
MAGNUM 500/EB	2000	3211077	70-03854	63,60
NORWEGIAN BIG BOSS 500 6X6	1998	3211077	70-03854	63,60
NORWEGIAN MAGNUM 4X4	1998	3211077	70-03854	63,60
PTV 6X6	SERIES 10	3211077	70-03854	63,60
RANGER	SERIES 10	3211077	70-03854	63,60
RANGER	SERIES 11	3211077	70-03854	63,60
RANGER	1999	3211077	70-03854	63,60
RANGER 2X4 500 CARB	2009	3211077	70-03854	63,60
RANGER 2X4 500 CARB ISRAEL	2008-09	3211077	70-03854	63,60
RANGER 2X4,4X4,6X6	2004-05	3211077	70-03854	63,60
RANGER 4X4 400	2010	3211077	70-03854	63,60
RANGER 4X4 500 EFI	2008-10	3211077	70-03854	63,60
RANGER 500 2X4	2008	3211077	70-03854	63,60
RANGER 500 2X4 CARB ISRAEL	2007	3211077	70-03854	63,60
RANGER 500 2X4/4X4	2006-07	3211077	70-03854	63,60
RANGER 500 4X4 EFI	2006-07	3211077	70-03854	63,60
RANGER 500 6X6	SERIES 10	3211077	70-03854	63,60
SCRAMBLER 2X4	2000	3211077	70-03854	63,60

POLARIS	VM	OEM	Tuotenro	Osh.
SCRAMBLER 2X4 INTL	2008-09	3211077	70-03854	63,60
SCRAMBLER 400	1998-02	3211077	70-03854	63,60
SCRAMBLER 500	1999-00	3211077	70-03854	63,60
SCRAMBLER 500 2X4	2001-02	3211077	70-03854	63,60
SCRAMBLER 500 2X4 INTL	2007	3211077	70-03854	63,60
SCRAMBLER 500 4X4	2001-10	3211077	70-03854	63,60
SCRAMBLER 500 4X4 FREEDOM	2002	3211077	70-03854	63,60
SCRAMBLER 500 4X4 INTL	2008-10	3211077	70-03854	63,60
SPORT 400/L	1998-99	3211077	70-03854	63,60
SPORTSMAN 335	1999-00	3211077	70-03854	63,60
SPORTSMAN 400	2001-05	3211077	70-03854	63,60
SPORTSMAN 450	2006-07	3211077	70-03854	63,60
SPORTSMAN 500 ALL	1998-02	3211077	70-03854	63,60
SPORTSMAN 500 EFI	2007	3211077	70-03854	63,60
SPORTSMAN 500 HO	2008-10	3211077	70-03854	63,60
SPORTSMAN 500 HO	2006	3211077	70-03854	63,60
SPORTSMAN 500 HO INT'L	2006	3211077	70-03854	63,60
SPORTSMAN 500 HO INTL	2010	3211077	70-03854	63,60
SPORTSMAN 6X6	2000-08	3211077	70-03854	63,60
Swedish Big Boss 500 6X6	1998	3211077	70-03854	63,60
SWEDISH MAGNUM 4X4	1998	3211077	70-03854	63,60
TRAIL BLAZER	1998-06	3211077	70-03854	63,60
TRAIL BLAZER 330	2008-10	3211077	70-03854	63,60
TRAIL BLAZER 330 INTL	2010	3211077	70-03854	63,60
TRAIL BLAZER 400	2003	3211077	70-03854	63,60
TRAIL BLAZER FREEDOM	2002	3211077	70-03854	63,60
TRAIL BOSS	1999-02	3211077	70-03854	63,60
TRAIL BOSS 330	2003-10	3211077	70-03854	63,60
TRAIL BOSS 330 INTL	2010	3211077	70-03854	63,60
UTV 2X4	SERIES 10	3211077	70-03854	63,60
UTV 2X4/4X4/6X6	SERIES 11	3211077	70-03854	63,60
UTV 4X4	SERIES 10	3211077	70-03854	63,60
WORKER 335	1999	3211077	70-03854	63,60
WORKER 500	2001	3211077	70-03854	63,60
XPLORER	2000-01	3211077	70-03854	63,60
XPLORER 300	1998-99	3211077	70-03854	63,60
XPLORER 400	1998-02	3211077	70-03854	63,60
XPRESS 300	1998-99	3211077	70-03854	63,60

SUZUKI				
Eiger 400 Auto	2003-09	27601-38F00	70-03859	63,60
King Quad 400	2008-09	27601-38F00	70-03859	63,60

YAMAHA				
YFM400/450 AUTOMATIC	2000-09	5GH-17641-00-00	70-03516	63,60
BRUIN 350 4X4 AUTO	2004-06	5GH-17641-00-00	70-03516	63,60
KODIAK 400 4X4 2X4	2001-06	5GH-17641-00-00	70-03516	63,60
KODIAK 2X4 4X4	2000-01	5GH-17641-00-00	70-03516	63,60
KODIAK 450 4X4 AUTO	2001-06	5GH-17641-00-00	70-03516	63,60
GRIZZLY 350 4X4 /2X4	2007	5GH-17641-00-00	70-03516	63,60
GRIZZLY 400	2007	5GH-17641-00-00	70-03516	63,60
GRIZZLY 450 4X4 /IRS	2007-09	5GH-17641-00-00	70-03516	63,60



KIINA-ATV			
Comanche	743 = Hihnan pituus mm	70-03779	32,00
Rally	20 = Leveys mm		
Linhai	30 = Hampaan kulma		
CF-Moto			
KinRoad			



Vanteet ja renkaat



Talvituoitteet



Vinsit



Laukut ja tuulisuojat



Sähköosat



Jousitus ja voimansiirto



Pakoputket ja suutinsarjat



Ohjaus



Rungon osat ja peitteet



Jarrupalat ja rattaat



Moottori



Variaattorin osat



Maatalous-tarvikkeet



Kärtyt ja reet



Kärtyt ja reet



Kärtyt ja reet



Kärtyt ja reet



Kärtyt ja reet



Kärtyt ja reet



MAATALOUSTARVIKKEET

BRONCO ATV COMPONENTS



Vanteet ja renkaat



Talvituotteet



Vinssit



Laukut ja tuulisuojat



Sähköosat



Jousitus ja voimansiirto



Pakoputket ja suutinsarjat



Ohjaus



Rungon osat ja peitteet



Jarrupalat ja rattaat



Moottori



Variaattorin osat



Maataloustarvikkeet



Kärryt ja reet



3-pistenostin Bronco/yleismalli

Sopii lähes kaikkiin malleihin IRS-jousituksella.

Tuoteno.	Hinta
77-12148	799,-



Takalana

Maan ja lumen siirtoon. Työstöleveys 136cm tai 152 cm riippuen valitusta puskulevystä.

Tuoteno.	Tuote	Hinta
77-12149	Runko	274,00
75-12470	Puskulevy 136x40cm	239,50
75-12469	Puskulevy 152x40cm	264,20



Levitin



Ohjaus



Rungon osat ja peitteet



Jarrupalat ja rattaat



Moottori



Variaattorin osat



Maataloustarvikkeet



Kärryt ja reet



Maataloustarvikkeet



Kärryt ja reet



Maataloustarvikkeet



Maataloustarvikkeet



Maataloustarvikkeet

uutuus!



Jyrä yleismalli 122cm LRP-2448

Tukevan rakenteensa ansiosta jyrä on täydellinen väline maan tiivistämiseen ja tasoittamiseen esim. nurmikolla tai vastakylvetyllä alueella. Leveys 122cm, vesitäytettynä 382kg.

uutuus!



Levitin yleismalli ATV-DMS 12V

Helppo ja kätevä yleislevitin lannoitteiden, suolan, hiekan ym. levittämiseen. Säädettävä levitysleveys 1,5m-13,5m. Säiliön tilavuus 63l.

Tuoteno	Osh.
77-1-5301845	629,00

Tuoteno	Osh.
77-1-5301948	437,50

Niittyleikkuri ATVM-120

uutuus!

- Säädettävä leikkauskorkeus 40-95mm
- Kelamurskaimessa 28 terää.
- Kääntyvä puomi 50mm vetonupille.
- Vetopuomin saa 3:een eri asentoon: Suora/ oikea/vasen
- Honda GX390 moottori 13hk
- Renkaiden mitat 16x6.50
- Leveys 1200 mm
- Paino 237 kg
- Takuu 1 vuosi

Tuoteno	Osh.
77-12490	2129,00



Tuoteno	Tuote	Hinta
77-12490-1	Varaterät	3,50
77-12490-2	Varahihna	6,00
77-12490-3	Hihnapyörä, ylä	40,00
77-12490-4	Hihnapyörä, ala	18,00
77-12490-5	Kirstypsyörä	45,00

ATV



Ruiskutuslaite puomilla ATV15-2



Tarkoitettu kevyempään ruiskutukseen. Varustettu 57 litran säiliöllä ja 1,0 G.P.M High flo 12V 35psi pumpulla. Maksimi ruiskutuspituus: pysty 5,4m, vaaka 7,8m. Mukana 46cm käsisuihkutuslaite säädettävällä suuttimella sekä 4,5m letku. Levitimessä kaksi säädettävää suutinta, max levitin 205cm. Minimipumppaus 1,0 G.P.M



Tuotenro	Osh.
77-1-5300936	452,50

Ruiskutuslaite puomilla ATV25-700



Tarkoitettu suurempaan ruiskutukseen. Varustettu 94 litran säiliöllä sekä 2,1 G.P.M High flo 12V 60psi pumpulla. Maksimi ruiskun pituus: pysty 4,5m, vaaka 9,0m. Mukana 46cm:n käsisuihkutuslaite säädettävällä suuttimella ja 4,5m letkulla. Kokoontaitettava levitin viidellä säädettävällä suuttimella. Maksimi levitin: 255cm. Minimipumppaus 2,1 G.M.P



Tuotenro	Osh.
77-1-5301273	634,50



Vanteet ja renkaat



Talvituoitteet



Vinsit



Laukut ja tuulisuojat



Sähköosat



Jousitus ja voimansiirto



Pakoputket ja suutinsarjat



Ohjaus



Rungon osat ja peitteet



Ruiskutuslaite LG-15-EC

Tarkoitettu kevyempään ruiskutukseen. Varustettu 57 litran säiliöllä ja 1,0 G.P.M High Flo 12V 35psi -pumpulla. Maksimi suihkun pituus: Pysty 5,4m, vaaka 7,8m Mukana 46cm käsisuihkutuslaite säädettävällä suuttimella sekä 4,5m letku.

Tuotenro	Osh.
77-1-5301302	227,50



Ruiskutuslaite LG-25-EC

Tarkoitettu suurempaan ruiskutukseen. Varustettu 94 litran säiliöllä ja 1,0 G.P.M High flo 12V 35psi -pumpulla. Maksimi suihkun pituus: Pysty 3,6m, vaaka 7,5m Mukana 46cm käsisuihkutuslaite säädettävällä suuttimella sekä 4,5m letku.

Tuotenro	Osh.
77-1-5301378	256,50



Puomi, 2 suuttimella



Levitin kahdella säädettävällä suuttimella. Max levitin: 205cm. Minimipumppaus 1,0 G.P.M, sopii LG-15EC, LG-25EC

Tuotenro	Osh.
77-1-5301230	203,00



Jarrupalat ja rattaat



Moottori



Variaattorin osat



Maataloustarvikkeet



Kärkyt ja reet



Ruiskutuslaite LG-29-P

Tarkoitettu suurempaan ruiskutukseen. Varustettu 94 litran säiliöllä ja 2,1 G.P.M High flo 12V 60psi -pumpulla. Maksimi suihkun pituus: Pysty 4,5m, vaaka 9,0m Mukana 46cm käsisuihkutuslaite säädettävällä suuttimella sekä 4,5m letku.

Tuotenro	Osh
77-1-5300632	303,00



Puomi, 5 suuttimella



Kokoontaitettava levitin viidellä säädettävällä suuttimella, max levitin: 255cm. Minimipumppaus 2,1 G.P.M, sopii LG-29 P

Tuotenro	Osh.
77-1-5301231	327,50

Ruiskutusvaunu TR-30 EX

Tarkoitettu ammattikäyttöön. Suuri kapasiteetti. Varustettu 114 litran säiliöllä. Varustettu 2,1 G.P.M High flo 12V 60psi pumpulla. Maksimi ruiskutuspituus käsisuihkutuslaitteessa: pysty 4,5m, vaaka 9,0m Mukana 46cm käsisuihkutuslaite säädettävällä suuttimella, 4,5m letku, levitin, sekä 2 suutinta. Levittimen leveys 205cm.

Tuotenro	Osh.
77-1-5301486	648,50





Vanteet ja renkaat



Talvituotteet



Vinssit



Laukut ja tuulisuojat



Sähköosat



Jousitus ja voimansiirto



Pakoputket ja suutinsarjat



Ohjaus



Rungon osat ja peitteet



Jarrupalat ja rattaat



Moottori



Variaattorin osat



Maatalous-
tarvikkeet



Kärryt ja reet

BRONCO

ATV COMPONENTS

PERÄKÄRRYT JA REET



Tukkikärry ATV 2000

- Säädettävä pituus 2100mm - 3600mm
- Leveys 1250mm
- Paino 180kg
- Maksimi kuorma 1500kg
- Rengaskoko 22x11-8

Tuotenro	Osh.
77-12177	806,-

Numeroiden selitykset viereisellä sivulla ▶

ATV

Tukkikärry lavalla

- Säädettävä pituus 2100mm - 3600mm
- Leveys 1250mm
- Lavan mitat: 2000 x 1000 mm
- Paino 180kg
- Rengaskoko 22x11-10

Tuotenro Osh.
77-12180 | 1168,-



HUOM! Sisältää lavan, kiinnikkeet ja tukkipankot!

LISÄVARUSTEET TUKKIKÄRRYYN



Tukkikärryn nostopuomi

Tuotenro	Tuote	Ovh.
77-12175	Nostopuomi	180,50



Tukkiohjuri nostopuomiin

Tuotenro	Tuote	Ovh.
73-1402	Tukkiohjuri	39,90



Juontosakset

Tuotenro	Tuote	Ovh.
73-1401	Juontosakset kahvalla	76,00
73-1400	Juontosakset ilman kahvaa	69,00



Vinssin kiinnikesarja

HUOM! Vinssivaihtoehdot löydetä vinssi-sivuilta.

Tuotenro	Tuote	Ovh.
73-1399	Vinssin kiinnikesarja	69,60



Lisävalon teline

uutuus!

Tuotenro	Tuote	Ovh.
73-1404	Kiinnitysteline	34,50
109-809015	Strands Led-työvalo 15W	28,00
M14-925-01	Katkaisija on/off 15A	4,80
M14-925-03	Katkaisijan suojakumi	1,80



Tukijalka tukkikärryyn

Käännettävissä 180 astetta. Toimii myös seisontatukena.

Tuotenro	Tuote	Ovh.
73-1403	Tukijalka tukkikärryyn	96,-

Varaosat tukkikärryihin:

Tuotenro	Kuva	Tuotteen nimi	Hinta
77-12177-1	1	Keskipalkki	92,00
77-12177-2	2	Etusuojuus	139,50
77-12177-3	3	Runko	83,00
77-12177-4	4	Pankkojen pidike	32,00
77-12177-5	5	Akseli	65,00
77-12177-6	6	Napa	35,00
77-12177-7	6	Pyörän laakeri isompi	6,10
77-12177-8	6	Pyörän laakeri pienempi	4,30
77-12177-9	6	Muovinen suoja-kapseli	2,60
77-12177-10	6	Tiiviste	3,00

Tuotenro	Kuva	Tuotteen nimi	Hinta
77-12177-11	12	Sivutuki eteen	38,00
77-12177-12	7	Sivutuki taakse	38,00
77-12177-13	8	Irrotettava pankka	9,50
77-12177-14	9	Kääntyvä vetopuomi	30,00
77-12177-15	3	Kiinnitys tappi	5,00
77-12177-16	10	Atv tukkikärryyn vetopää	21,20
77-12177-17	6	Navan mutteri	1,85
77-12177-18	6	Akseli täydellinen	139,00
76-005-R	11	Rengas oikea	92,00
76-005-L	11	Rengas vasen	92,00



Lavan kiinnikesarja tukkikärryyn, RST

uutuus!

Tuotenro	Tuote	Ovh.
77-12177-19	Lavan kiinnikesarja tukkikärryyn	69,60



Vanteet ja renkaat



Talvituotteet



Vinssit



Laukut ja tuulisuojat



Sähköosat



Jousitus ja voimansiirto



Pakoputket ja suutinsarjat



Ohjaus



Rungon osat ja peitteet



Jarrupalat ja rattaat



Moottori



Variaattorin osat



Maatalous-tarvikkeet



Kärryt ja reet



Vanteet ja renkaat



Talvituotteet



Vinssit



Laukut ja tuulisuojat



Sähköosat



Jousitus ja voimansiirto



Pakoputket ja suutinsarjat



Ohjaus



Rungon osat ja peitteet



Jarrupalat ja rattaat



Moottori



Variaattorin osat



Maatalous-tarvikkeet



Kärryt ja reet

ATV



BRONCO
ATV COMPONENTS

Tukkipöytä ATV Grapple Crane 350-I ja 350-II

Tuotenumero	Tuote	Osh.
77-12191	350 -II hydraulisella vedolla	7650,-
77-12191-1	350 -II hydraulisella vedolla ja hydraulisella vinssillä	8370,-

- Max ulottuvuus: 3,5 m
- Nostokyky 2,0 m: 300 kg
- Nostokyky 3,5 m: 200 kg
- Paino: 90 kg
- Hydrauliiikan moottori: 7,5hv
- Pumpun tuotto: 4ML/R
- Työpaine: 16MPa

PERÄKÄRRYT



Otter
Outdoors

Peräkärry Otter Xpress Trailer

uutuus!

- Kantavuus: 908 kg
- Mitat: 165cm x 117cm x 36cm
- Materiaali: muovi
- Takuu: 3 vuotta

Tuotenumero	Hinta
77-4720	825,-

PERÄKÄRRYT

BRONCO
ATV COMPONENTS

Maastokärry 800

- Pituus: 2750 mm
- Leveys: 1050 mm
- Korkeus: 1250 mm
- Paino: 70 kg
- Kantavuus: 800 kg
- Rengaskoko: 22x11-8

Tuotenumero	Tuote	Osh.
77-12179	Maastokärry 800	604,-
77-12179-5	Häkki	94,-



Maastokärry 600

- Pituus: 1890 mm
- Leveys: 950 mm
- Laidan korkeus: 630 mm
- Paino: 88 kg
- Kantavuus: 600 kg
- Rengaskoko: 22x11-8

Tuotenumero	Tuote	Osh.
77-12195	Maastokärry 600	469,-
77-12195-1	Kääntyvä vetopuomi	59,-





Vanteet ja renkaat



Talvituotteet



Vinsit



Laukut ja tulisuojat



Sähköosat



Jousitus ja voimansiirto



Pakoputket ja suutinsarjat



Ohjaus



Rungon osat ja peitteet



Jarrupalat ja rattaat



Moottori



Variaattorin osat



Maatalous-tarvikkeet



Kärryt ja reet

REET



Reki Otter Magnum

- Mitat: 188cm x 96,5cm x 30,5cm
- Paksuus: 8mm
- Väri: Musta
- Takuu: 3 vuotta

Tuotenumero	Hinta
77-1140	234,00



Reki Otter Small

- Mitat: 137cm x 66cm x 20cm
- Paksuus: 8mm
- Väri: Musta
- Takuu: 3 vuotta

Tuotenumero	Hinta
77-1139	108,00



Reki Otter Mini

- Mitat: 110 cm x 59 cm x 27 cm
- Paksuus: 8mm
- Väri: Musta
- Takuu: 3 vuotta

Tuotenumero	Hinta
77-1138	66,00

uutuus!77-1226
77-1246

Rekien tarvikkeet

Tuotenumero	Tuote	Hinta
77-0400	Vetopuomisarja	88,00
77-0400-1	Vetopuomisarjan adapteri MK	12,10
77-1226	Suojakiskot, small	45,00 (6pkk.)

77-1320
77-1340

Tuotenumero	Tuote	Hinta
77-1246	Suojakiskot, magnum	92,00 (6pkk.)
77-1320	Suojapeite, small	79,50
77-1340	Suojapeite, magnum	90,50



77-0400

77-0400-1

VETOKOUKUT JA TARVIKKEET



Yhdistelmäkoukku

Tuotenumero	Tuote	Ovh.
76-23304	Yhdistelmäkoukku	49,90



Vetokoukun nuppi

Tuotenumero	Tuote	Ovh.
76-23303-1	Vetonuppi 50 mm (euro-koko)	15,50

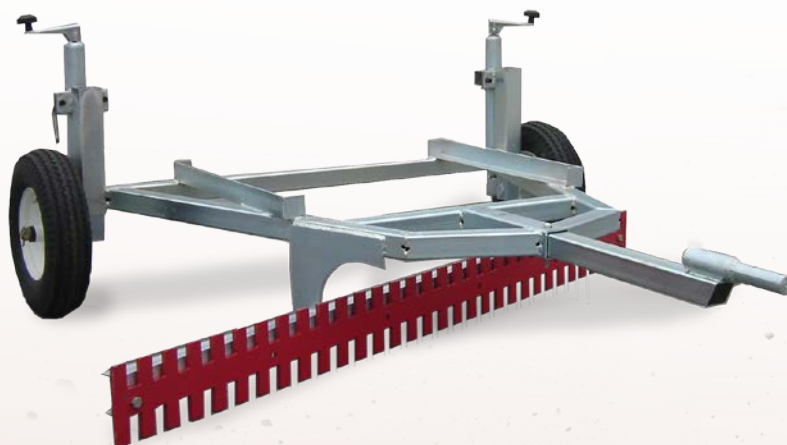
**BRONCO**
ATV COMPONENTS

Tielana

- Maan tasoittamiseen
- Työstöleveys 1800 mm

Tuotenumero	Osh.
77-12182	660,-

ATV

